

FUSION X LED WALLPACK/FLOOD LIGHT

INSTALLATION, USAGE, & CARE GUIDE

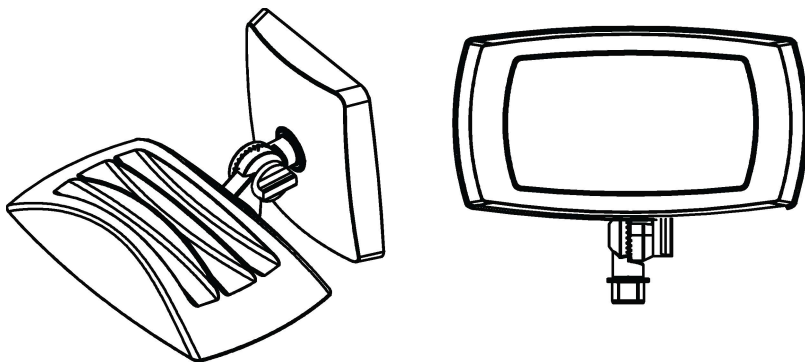

Questions? / Missing Parts? / Need Accessories?

Before returning to the store, call, text, or email PROBRITE
Customer Care 9am-5pm EST Monday to Friday.

1-844-507-5651

support@PROBRITE.com

PROBRITE.COM

Visit us online anytime or call us to get information on our product range, download detailed spec & photometric files, find product and mounting accessories, view installation tutorials and videos, and learn about our DLC® rebate eligible products.

TABLE OF CONTENTS

| | | | |
|---------------------------------|----------|----------------------------------|-----------|
| Table of Contents | 2 | Hardware Included..... | 4 |
| Safety Information | 2 | Installation | 5 |
| Pre-Installation | 3 | Operation | 10 |
| Planning Installation..... | 3 | Care & Cleaning | 10 |
| Specifications..... | 3 | Troubleshooting | 11 |
| Tools Required..... | 3 | Warranty | 11 |
| Package Contents..... | 4 | | |

SAFETY INFORMATION

IMPORTANT

THIS PRODUCT MUST BE INSTALLED IN ACCORDANCE WITH THE APPLICABLE NATIONAL ELECTRICAL CODE AND LOCAL BUILDING CODES BY A PERSON FAMILIAR WITH THE CONSTRUCTION AND OPERATION OF THE PRODUCT AND THE HAZARDS INVOLVED.

PRECAUTIONS

- Please read and understand this entire manual before attempting to assemble, install, or operate this light fixture.
- This light fixture requires a 120-277 Volt AC power source.
- Some codes require installation by a qualified electrician.
- This light fixture must be properly grounded.
- Make sure connections are secure using wire nuts, crimp-on lugs or other approved connecting devices
- This light fixture should be installed outdoors to a wall or to the ground.

Save these instructions



WARNING: Turn the power off at the circuit breaker or fuse. Place tape over the circuit breaker switch and verify power is off at the light fixture.



WARNING: Risk of fire. Keep the fixture at least 3 in. (76mm) from combustible materials.



CAUTION: Burn hazard. Allow the light fixture to cool before touching.



NOTICE: Do not connect this fixture to a dimmer switch.

PRE-INSTALLATION

PLANNING INSTALLATION

Before installing the light fixture, ensure that all parts are present. Compare parts with the **Hardware Included** and **Package Contents** sections. If any part is missing or damaged, do not attempt to assemble, install, or operate this light fixture.

SPECIFICATIONS

| MODEL | FUSION X 15W | FUSION X 28W |
|------------------------------------|---|---------------------|
| Lumens (Light Output) | 1500 Lumens | 3000 Lumens |
| Watts (Power Consumption) | 15 Watts LED | 28 Watts LED |
| Replaces | 70W Incandescent | 100W Incandescent |
| Lumens/Watts (Efficacy) | 100 Lumens per watt | 107 Lumens per watt |
| Power Requirements (Input Voltage) | 120V AC | |
| Light Color (CCT) | 2700K, 3000K, 3500K, 4000K, 5000K (User Selectable) | |
| Dimmable | Non-Dimming (Do not wire to dimming switch) | |
| Operating Modes | Switch-Controlled: Flip switch to turn light fixture ON and OFF. <i>Use external photocell light sensor, timer or motion sensor for automatic functionality.</i> | |

TOOLS REQUIRED



Phillips screwdriver



Wire strippers/
cutters



Circuit tester



Silicone sealant



Work gloves



Ladder



Safety goggles

PRE-INSTALLATION (CONTINUED)

PACKAGE CONTENTS

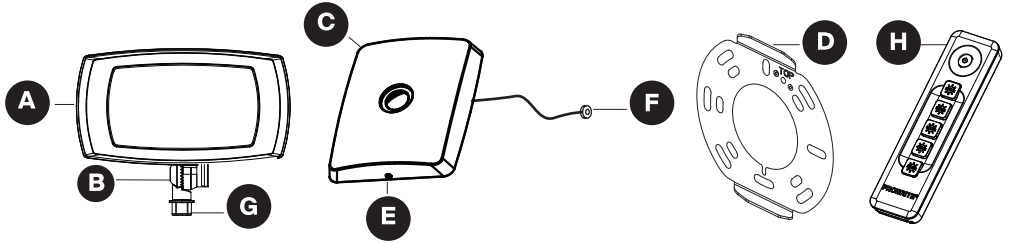

| Part | Description | Quantity |
|------|--------------------------------------|----------|
| A | Light fixture | 1 |
| B | 1/2" NPS Threaded knuckle mount stem | 1 |
| C | Wall/Eave mounting plate cover | 1 |
| D | Mounting plate (shipped installed) | 1 |
| E | Mounting plate set screw | 1 |
| F | Hands-free mounting wire | 1 |
| G | Conduit lock nut for knuckle mount | 1 |
| H | Remote control | 1 |



NOTE: Alternate mounting accessories are not provided in the box. They are available separately from your retailer.

HARDWARE KIT



NOTE: Hardware *not* shown to actual size.



| Part | Description | Quantity |
|------|---------------------------------|----------|
| AA | #8-32 x 3/4" Philips head screw | 2 |
| BB | Wire nut | 3 |
| CC | Hex head screwdriver | 1 |
| DD | Wing nut for wall mount plate | 1 |
| EE | Lock washer | 1 |
| FF | Sealing gasket | 1 |

INSTALLATION

1 FOR BEST RESULTS

- Install light 6-15 feet above the ground for wall applications or on ground for flood application.
- The fixture can be mounted in multiple ways:
 - A. Wall/Eave Mount:** Use the mounting plate (D) and the wall/eave mounting plate cover (C) over a junction box. See (fig 1) and (fig 2).
 - B. Swivel Knuckle Flood Mount:** Can be used with a domed cover plate (not provided) on a junction box or landscape ground post (not provided). See (fig 3) and (fig 4).
- Do NOT wire to a dimming switch.

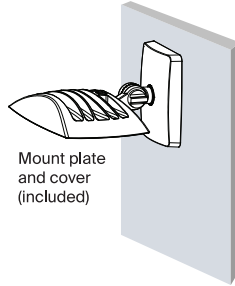

Wall Mount
(fig 1).

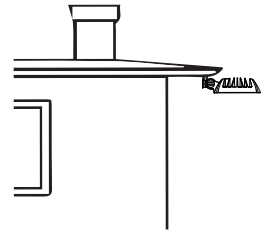

Eave Mount
(fig 2).



Swivel Knuckle Flood Mount
Mounted to domed cover plate with center hole
(fig 3).



Mounted to landscape post (sold separately)
(fig 4).

IMPORTANT INFORMATION: Domed cover plates for junction boxes, landscape posts, and other mounting arms and accessories are available. Please contact your retailer or PROBRITE's customer support.

2 SHUT OFF ELECTRIC POWER OFF

- Verify wall switch is in OFF position (fig 5).
- At the main electrical panel, turn off the circuit breaker that supplies power to the junction box you are working on (fig 6).
- For screw-in type fuses, unscrew the fuse that supplies power to the junction box you are working on (fig 7).

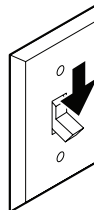

(fig 5).

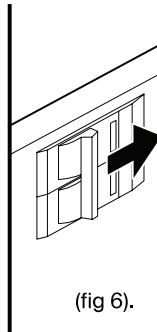

(fig 6).

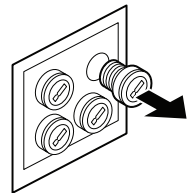

(fig 7).

INSTALLATION (CONTINUED)

3 OPTION: ASSEMBLE THE WALL/EAVE MOUNTING PLATE COVER

(for wall/eave mounting over standard recessed junction box)



NOTE: The fixture comes with the knuckle stem and the wall/eave mounting base plate cover (C) in the box.

- Place the sealing gasket (FF) on the knuckle stem and thread wires through the hole of the wall/eave mounting plate cover (C), being careful not to pinch the wires. (fig 8)
- Pass the fixture's threaded stem (B) thru the center hole of the mounting plate cover (C). Secure with the lock washer (EE) and tighten with the wing nut (DD). (fig 9)



IMPORTANT: Adjust the desired left to right orientation of the fixture head (A) on the wall/eave mounting plate cover (C) at this step. (fig 10)

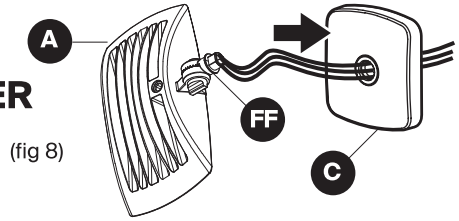

(fig 8)

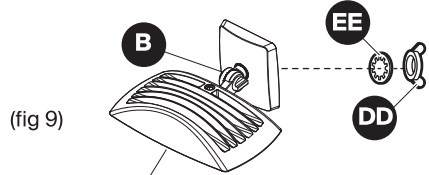

(fig 9)

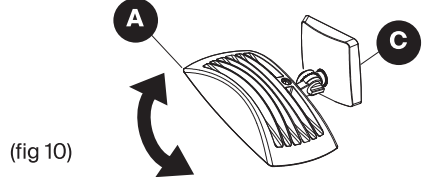

(fig 10)

4 OPTION: MOUNT TO SURFACE MOUNT JUNCTION BOX OR LANDSCAPE GROUND POST

For Ground and Wall/Eave Mounting



NOTE: The fixture comes with the 1/2" threaded NPS swivel knuckle stem (B) and is compatible with standard domed junction box covers and landscape ground posts which are sold separately

- Place wires through the hole in the domed junction box cover or landscape ground post (fig 11) and (fig 12).
- Place conduit lock nut (G) on back side of domed cover.
- Screw 1/2" NPS threaded knuckle mount (B) into the center hole of the domed plate or landscape post and, if hole isn't threaded, use conduit lock nut (G) to tighten fixture into place.
- Use provided hex head screwdriver to loosen orbit bolt in center of knuckle mount and select desired angle. Tighten screw to secure into place.

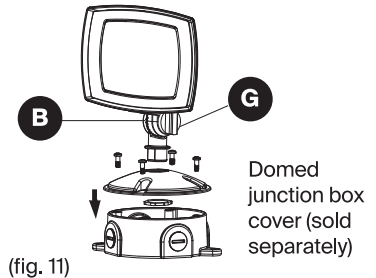

(fig 11)

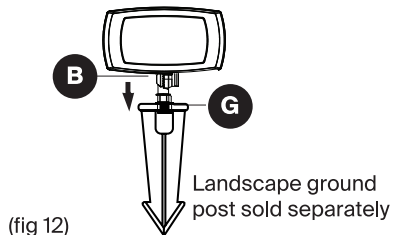

(fig 12)

INSTALLATION (CONTINUED)

5 ATTACH THE MOUNTING PLATE TO JUNCTION BOX

(for wall/eave mounting over standard recessed junction box)

- To remove the mounting plate (D) from the back of the fixture, loosen the set screw (E) using the hex head screwdriver (CC). (fig 13)
- Align the holes of the mounting plate (with the "TOP" marking oriented upwards OR closest to wall if eave mounted) with the junction box. Secure the mounting plate (D) to the junction box with the two #8 screws (AA). (fig 14)

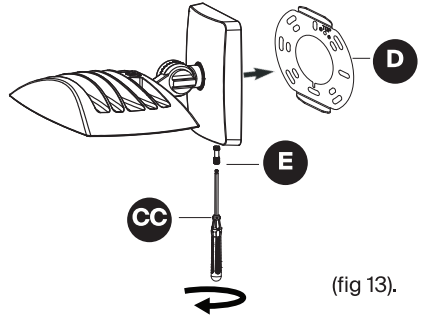

(fig 13).



TIP: Only unscrew the mounting plate set screw (E) far enough to remove the mounting plate (D). Do not fully remove set screw (E).



NOTE: Use any other suitable bolts or fasteners as applicable for attachment to your mounting surface.

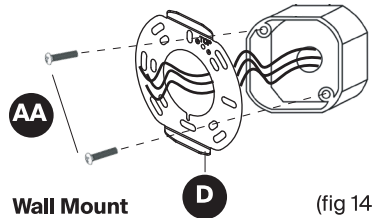

(fig 14).

6 ATTACH HANDS-FREE WIRE

(for wall/eave mounting over standard recessed junction box)

- Take the round "ball" head of the hands-free wire (F), attached to back of mounting plate cover, and place it behind the bottom-center "notch" of the mounting plate (D)
- Ensure the fixture can now hang freely to allow for hands-free connection of the electrical wires

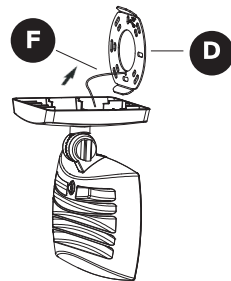

Wall/Eave Mount

(fig 15).

INSTALLATION (CONTINUED)

7 MAKE THE ELECTRICAL CONNECTIONS

- If necessary, strip 3/8" of insulation from junction box and lighting fixture wires.
- Connect wires by twisting the exposed wires together and using the wire nuts (BB). Ensure no loose wires.
- Connect lighting fixture black wire to junction box black wire, (line), lighting fixture white wire to junction box white wire (common), the junction box ground wire to the green lighting fixture ground wire.

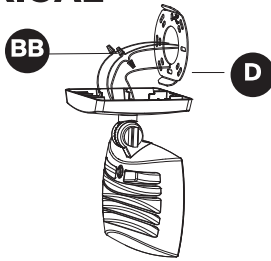

Wall Mount

(fig 16).

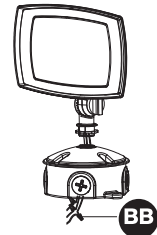

Swivel Knuckle Flood/
Surface Mount

(fig 17).

Non-Dimming Wiring Diagram

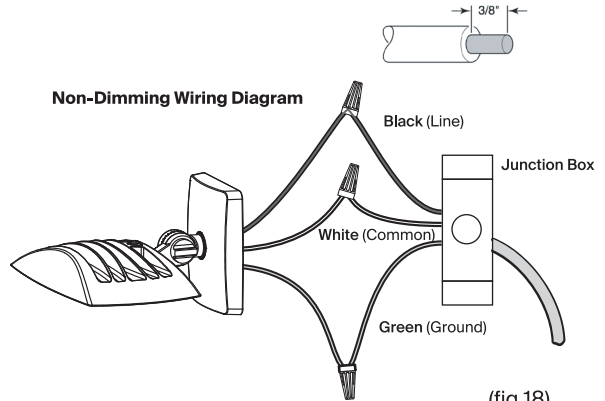

(fig 18).



TIP: Hold stripped ends near each other and align any frayed strands (do not twist wires).

Push the wires into wire nut (BB) and use your fingers to twist the wire nut clockwise until tight. Check for tightness by pulling wires.

8 SECURE THE FIXTURE AND WIRING

Wall/Eave mount over standard recessed junction box

- Once the fixture is wired, place the fixture on the mounting plate. Use hex head screwdriver (CC) to tighten the set screw (E) to secure the fixture to the mounting plate (D)
- Ensure no wires are pinched between mounting plate cover (C) and mounting surface

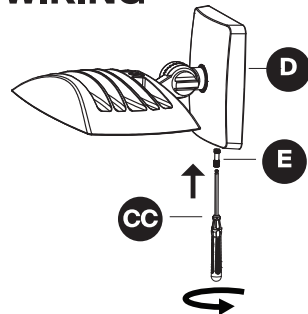

(fig 19).



NOTE: After electrical connections are made un-hook the hands-free wire (F) and then mount the fixture onto the mounting plate (D).

INSTALLATION (CONTINUED)

9 SEAL WITH CAULKING

- For recessed junction box mounting, caulk around the back face of the light fixture shown in (fig 20) with silicone sealant (not included).
- For surface mount junction box applications, caulk between the junction box and mounting plate with silicone sealant (not included) as shown in (fig 21).

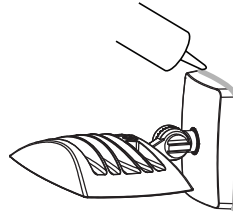

(fig 20).

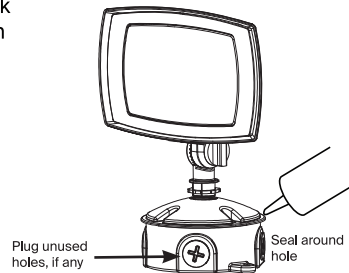

Swivel Knuckle Flood Mount

(fig 21).



NOTICE: Failure to properly caulk around the back face of the light fixture and mounting surface could lead to water damage and is not covered under warranty.

10 ADJUST THE LAMP HEAD AND TEST

- Loosen the screw on swivel portion of the knuckle (B), adjust the fixture to a suitable orientation, and then tighten the screw.
- Test fixture by restoring power to the breaker and light switch. Verify that light fixture illuminates. Adjust aiming angle as needed.

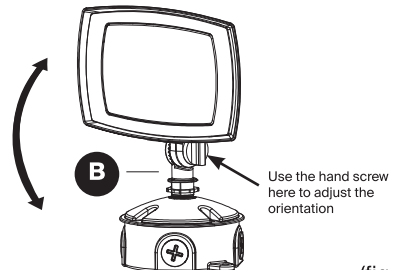
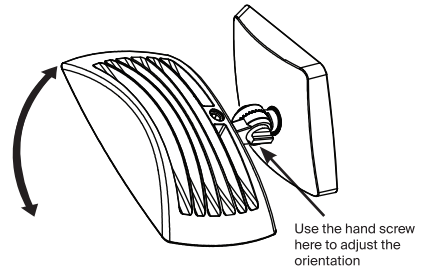

(fig 22).

OPERATION

1 SELECT COLOR TEMPERATURE (CCT)

- Standing within 15 feet, aim the remote control (H) at the front of the light fixture. Note: IR receiver is behind fixture lens.
- The remote has six buttons: ON/OFF, 2700K, 3000K, 3500K, 4000K and 5000K. Press the buttons to preview the correlated color temperatures (CCT).
- Once you make a selection, keep the light turned on at the selected color temperature for at least 5 seconds to store the selected color into memory (this will ensure it always turns on to the last selected color).
- To change light color at any time, point the remote at the fixture lens (within 15 feet) and select desired color temperature.

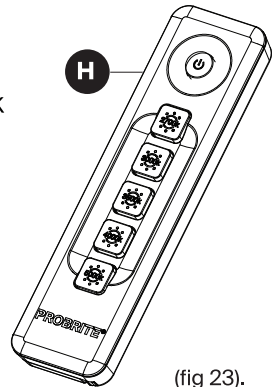

(fig 23).

SWITCH-CONTROLLED

Switch-controlled operation enables the light fixture to turn ON and OFF by flipping a standard light switch. Dusk-to-Dawn control requires addition external photocell, sensors or timer (sold separately).

- Once the fixture is installed, turn power back on from the circuit breaker and switch.
- Flip switch ON and OFF to ensure light functions properly.

SWITCH



CONTROLLED



NOTE: This fixture is not dimmable, so it is best to not wire to a dimming switch.

CARE AND CLEANING

- Shut off main power supply before cleaning the product. To prolong the original appearance, clean the light fixture with clear water and a soft, damp cloth only.
- Do not use abrasive cleaners or cleaners that contain alcohol. Do not apply paints, solvents, or any other chemicals on this light fixture. They could cause a premature deterioration of the finish and may void the warranty.
- Do not spray the light fixture with a hose or power washer.

TROUBLESHOOTING

If Light does not come on:

- Verify that the power is turned ON from the circuit breaker and wall switch.
- Verify the wiring for the fixture is done properly.
- Verify the line voltage is correct.

If Light flickers:

- Do not wire to a dimming switch, use a standard ON/OFF switch

5-YEAR LIMITED WARRANTY

This is a limited warranty offered by Probrite for a period of five years from the date of purchase to its customers. Probrite warrants to customers that the products will be free from defects in material and workmanship. The obligation of Probrite under this warranty is limited to the provision of replacement of products and is extended to the original purchaser of the product on presenting valid purchase receipt or other proof of date of original purchase acceptable to Probrite. The receipt is required for rendering the warranty performance. Any warranty claims without original proof of purchase would not be accepted.

It should be noted that the warranty does not apply to Probrite products that have been altered or repaired by unauthorized personnel, have been subjected to neglect, abuse, misuse or accident or damages caused during shipping. Any other products not manufactured by Probrite which have been supplied, installed and/or used in conjunction with Probrite products are not covered under this warranty. Any damages caused by replacements bulbs, LEDs or corrosion or discoloration of brass components are also not covered by this warranty.

Limitation of Liability:

In no event Probrite shall be liable for indirect, consequential, incidental or special damages, or lost profits. Probrite is not liable for any claims or damage arising out of or connected with the manufacture, sale, delivery, use, maintenance and repair or modification of Probrite products, or supply of any replacement parts that, exceed the purchase price of Probrite products giving rise to a claim. Labor charges to remove or install the fixtures will not be accepted.

To Claim:

Please contact PROBRITE customer service at 1-844-507-5651 or email support@PROBRITE.com and include your name, address and contact number, along with a copy of the purchase receipt and a brief description of the problem.

PROBRITE®

Questions? / Missing Parts? / Need Accessories?

Before returning to the store, call or email PROBRITE
Customer Service 9am-5pm EST Monday to Friday.

1-844-507-5651

support@PROBRITE.com

PROBRITE.COM

RETAIN THIS MANUAL FOR FUTURE USE

Para las translaciones en español,
visit www.probrite.com/install