

Owner Manual

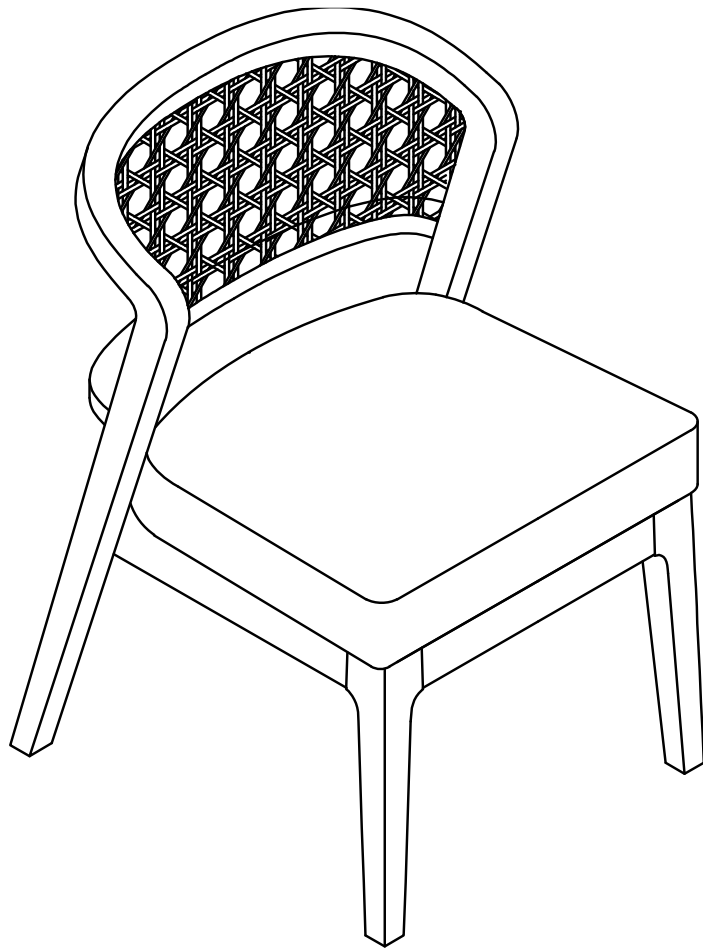

Per Seat Weight Limitation

300 LBS

*This brochure contains
IMPORTANT safety info.
Please read and keep it
for future reference.*

MAINTENANCE AND WARNINGS



Before You Start

Please follow the steps below:



- ⚠ Un box the package and check if all parts and accessories are complete.*
- ⚠ Place the parts of the sofa on a flat surface.*
- ⚠ Ensure the sofa is placed on a stable, flat surface to prevent it from tilting.*
- ⚠ Avoid placing sharp or heavy objects directly on the sofa to prevent tears or deformation.*
- ⚠ Follow the assembly instructions provided to attach the cushions, backrest, and armrests securely.*
- ⚠ Clean the installation area in advance and ensure the ground is level and there is enough space to avoid damaging the furniture or making installation difficult.*
- ⚠ Lay a protective mat on the ground to prevent scratching the floor during installation.*

After-Sales Service

- If you encounter any issues or need technical support during use, please contact our after-sales team. We offer long-term maintenance and warranty services.*





Precautions

-  This product for indoor use only. Do not expose it to outdoor elements or high-humidity environments.
-  Keep the product away from high heat or open flames to prevent fire hazards.
-  Do not allow children to climb on the product to prevent personal injury caused by tipping



Safety Warnings

-  If you notice any loose or damaged parts, stop using the product immediately and contact customer service.
-  Do not attempt to disassemble or replace any components yourself, as this may affect the stability and safety of the product.

Daily Maintenance

- Regularly clean the surface of the sofa with a soft cloth to prevent dust accumulation.
- Do not use cleaning agents containing acids, alkalis, or corrosive substances, as they may damage the surface. It is recommended to use neutral cleaning agents or specialized furniture cleaners
- Avoid exposing furniture to humid environments for extended periods to prevent swelling or deformation of the boards. Use a dehumidifier or desiccant during humid weather.
- Avoid direct contact of furniture with water. If water is accidentally spilled, wipe it dry immediately.
- Avoid placing excessively heavy objects on the furniture: ensure the weight is within a reasonable load-bearing range.
- Avoid using sharp or rough items on the furniture surface to prevent scratches, Handle items gently when moving them

Parts List

A

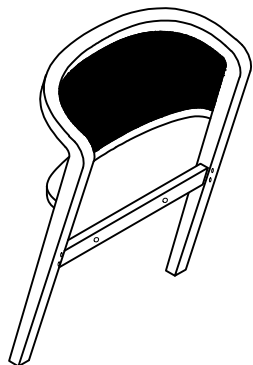

x1

Chair back

B



x2

Front legs

C

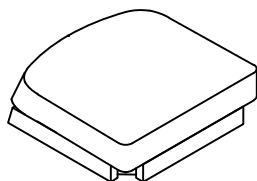

x1

Seat frame



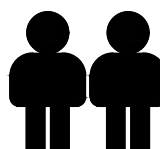

Installation:
15minutes.

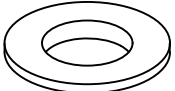

Two Person

Hardware List

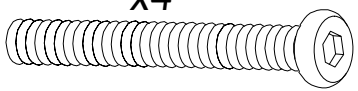
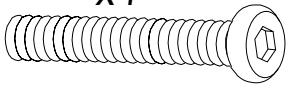
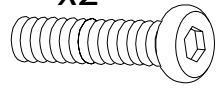
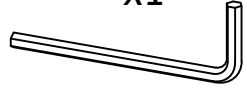
<p>1</p>  <p>x10+1</p> <p>Ø1/4x19mm</p>	<p>2</p>  <p>x10+1</p> <p>Ø1/4x13mm</p>	<p>3</p>  <p>x4</p> <p>Ø1/4x105mm</p>
<p>4</p>  <p>x4</p> <p>Ø1/4x65mm</p>	<p>5</p>  <p>x2</p> <p>Ø1/4x45mm</p>	<p>6</p>  <p>x1</p>

Step 1

Attach Seat frame (B) on the Chair back (A) by using Flat washer (1), Lock Washer (2), Bolt (5) with Allen Key (6).

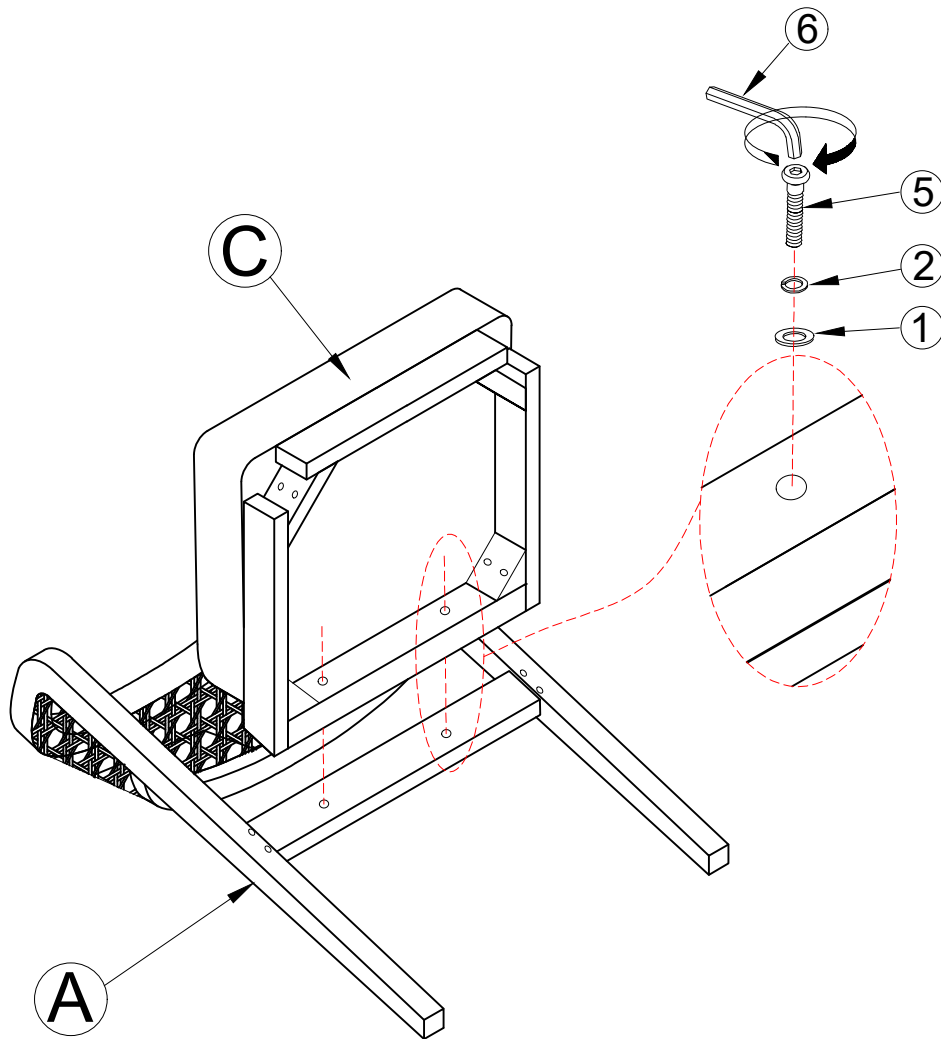



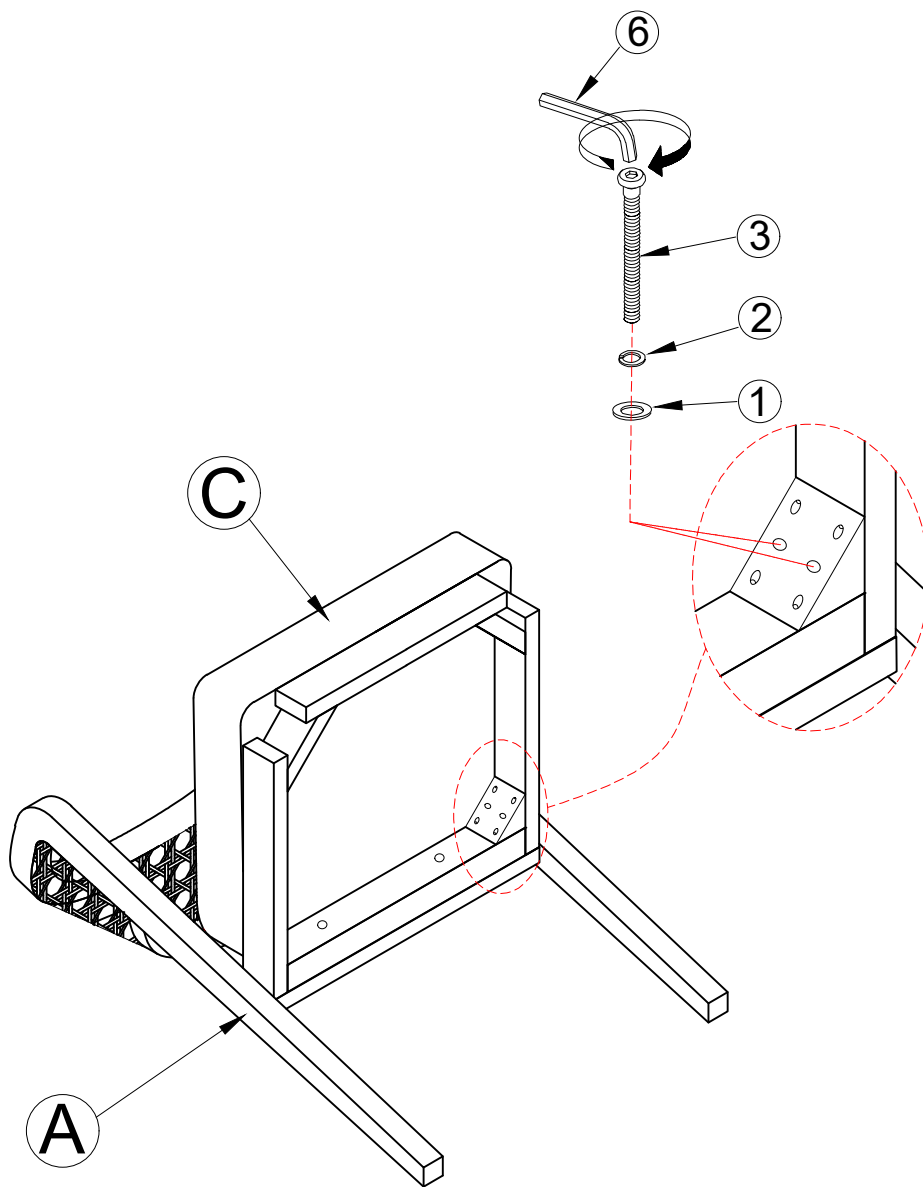

1	x2	2	x2	5	x2	6	x1
				Ø1/4x45mm			

Step 2

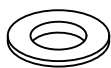
After connect Seat frame (B) with the Chair back (A) by using Flat washer (1), Lock Washer (2), Bolt (3) with Allen Key (6).

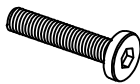

1	x4	2	x4	3	x4	6	x1
							
				Ø1/4x105mm			

Step 3

Attach Front legs (B) on the Seat frame (B) by using Flat washer (1), Lock Washer (2), Bolt (4) with Allen Key (6).

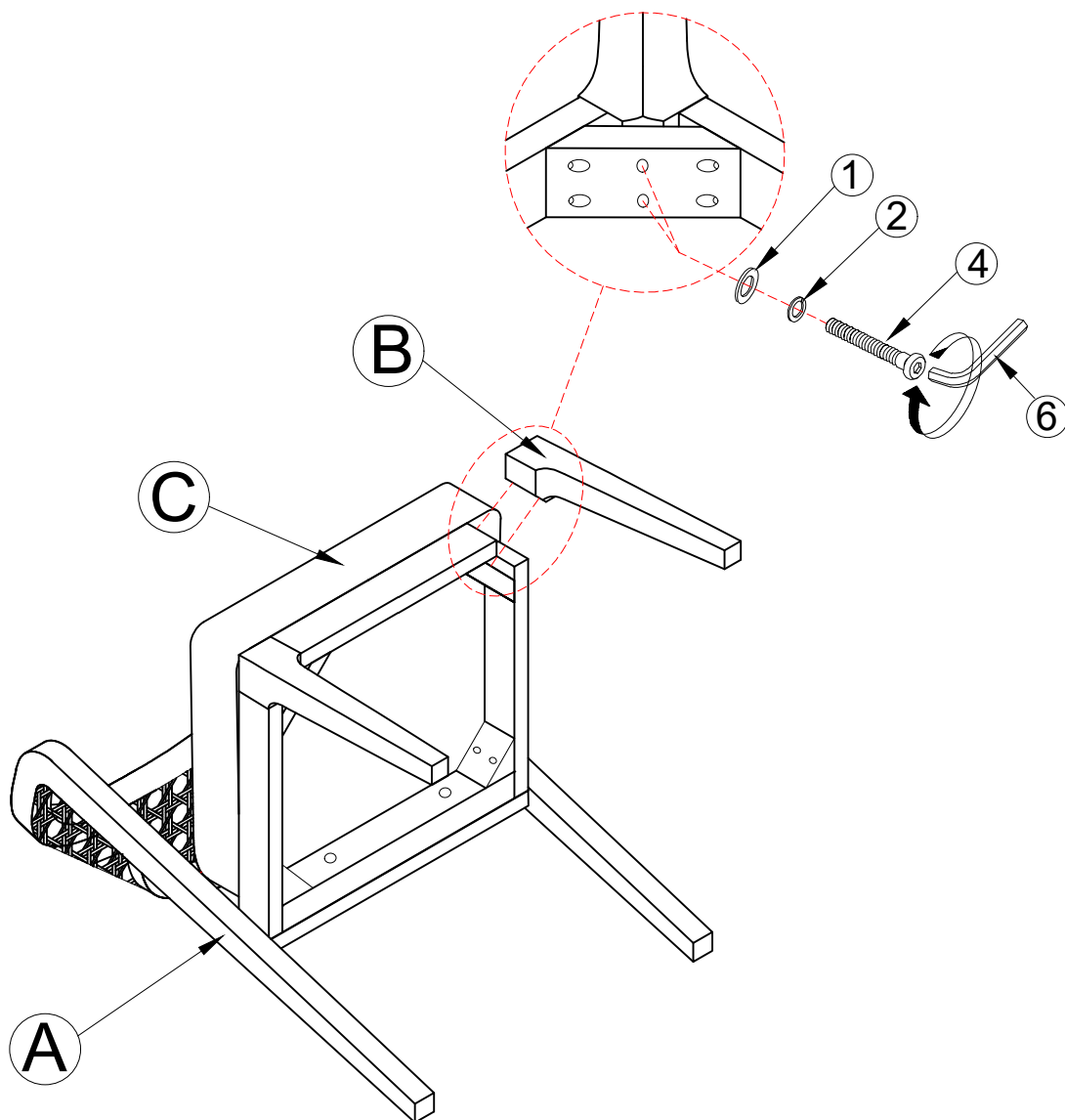

1	x4	2	x4	4	x4	6	x1
				Ø1/4x65mm			

Step 4

Adjust the level up and down to level the Chair. Chair is now ready for use.

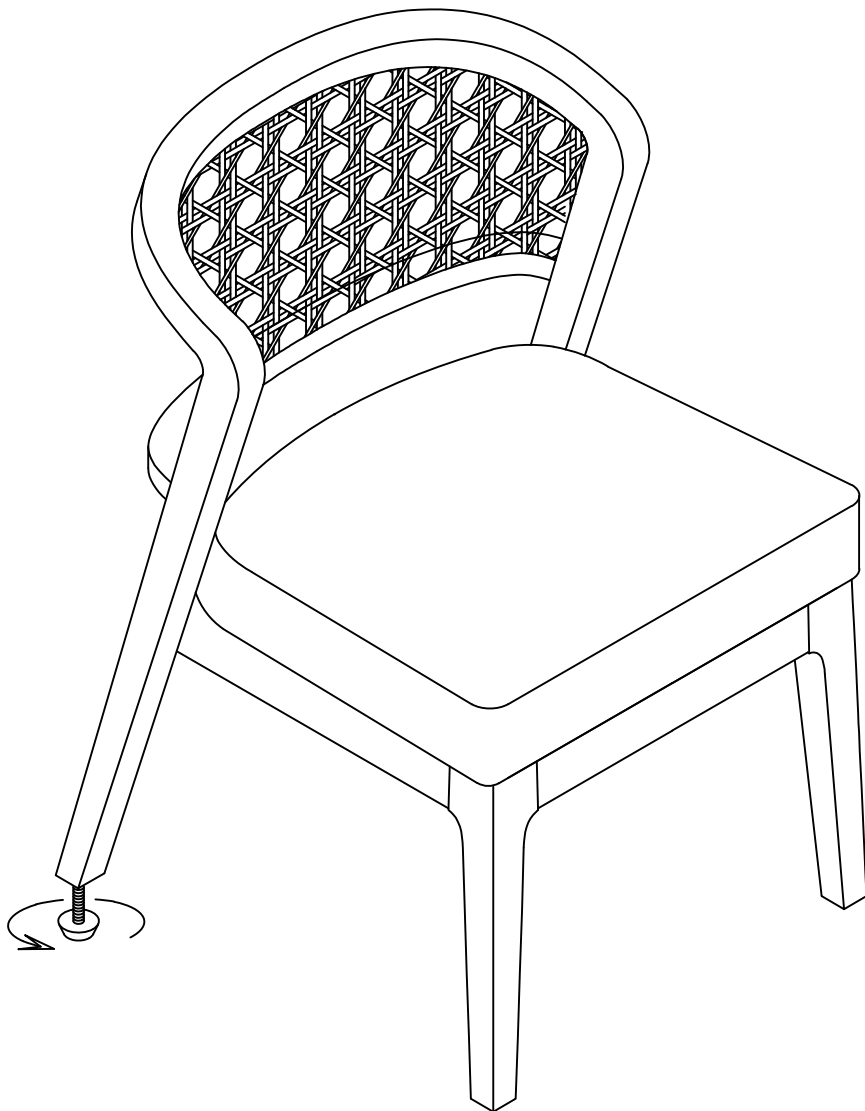

WARRANTY

- *We strive to offer quality products, and we also try our best to satisfy every customer who orders from us with products or services as needed.*
- *We provide 30 days warranty starting from the time you receive the item. Each customer must provide a record of their orders such as the order number, or item receipt for any items that are out of the warranty period you may also still receive.*
- *Replacement parts by purchasing them from our company if they are available.*
- *For return, please check the return policy with the retailer or market place you bought from*