



**Best Master Furniture™**

The Imported Furniture Specialist

# ASSEMBLY INSTRUCTIONS

MODEL #

NEWARK CHAIR

Hours of Operation

MON-FRI 8:00AM - 4:00PM (PT)

## TOOLS REQUIRED

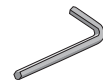
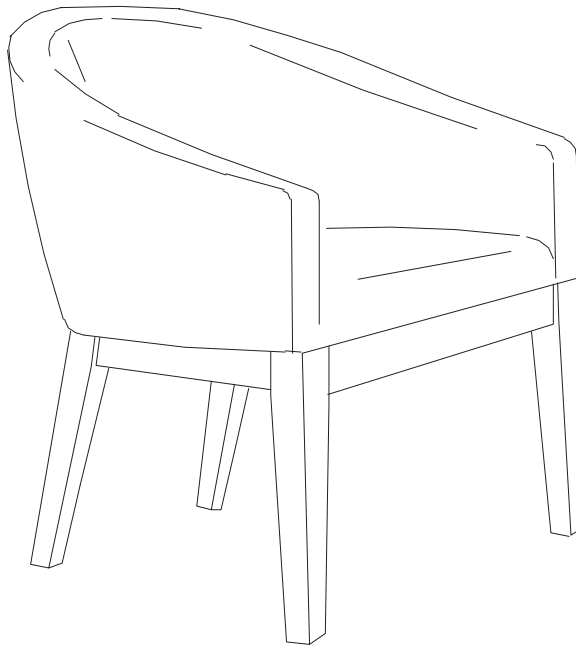

Allen Wrench  
(Included)



Mallet  
(Not Included)

Enjoy this product? We'd love your 5-star review!

If you have any issues, our support team is happy to help.

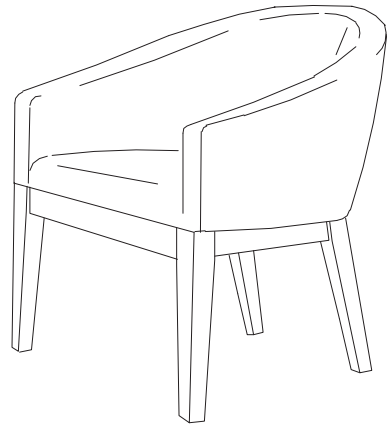

Thank you for your purchase!

## CONTACT US:



**Monday - Friday**  
8:00AM - 4:00PM PT



**Email**  
[inquiries@bestmasterfurnitures.com](mailto:inquiries@bestmasterfurnitures.com)



**Website**  
[www.bestmasterfurnitures.com](http://www.bestmasterfurnitures.com)



### CHECK BEFORE STARTING

Are you missing anything?

Please double check all hardware and parts match the assembly guide before putting the product together. If damaged, we suggest you put the item back in the box and start your claim or return.

Should we send any replacements?

If there are any manufacturer defects or missing pieces, please contact us for replacements. If purchased online, please contact the website of where you purchase it from, DIRECTLY.

## IMPORTANT INFO before assembly:

- If there's a problem with the parts do not attempt to assemble the product.
- Place all parts on a clean and smooth surface such as a rug / carpet to avoid parts from being scratched.
- When tightening screws to product do not overtighten until product is fully setup.
- If product is too heavy for a single person to carry do not attempt and ask for assistance.
- DO NOT DRAG or PUSH item to desired location. Must be carried when moving.
- If item is not working as intended, please review the assembly guide to see if any steps were missed or incorrectly built. If there's a problem with part, please contact seller for additional assistance.
- Please keep all hardware and small parts away from pets / infants.
- Please wear gloves or protective gear to protect from getting cuts.
- It is normal for new furniture to have an off gassing smell. Please air out furniture near a window for a few hours or a day before placing it in its desired location.
- All products may have a slight color and texture variation due to different shipments, natural materials, screen resolutions, or lighting in home. Images are rendered by different devices or websites.



- Please keep instructions for future reference.
- Check the quantity and irregularity of parts and hardware before you start.
- If assembly guide is misplaced, please visit our website for copy

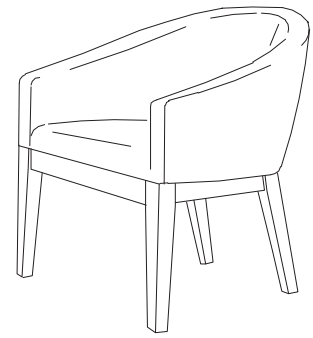

## NEWARK CHAIR

### Part List (Two Chairs)

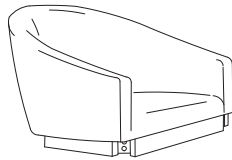

**P1**  
CHAIR SEAT  
2 pcs

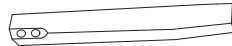

**P2**  
FRONT LEG  
4 pcs



**P3**  
BACK LEG with sticker (R)  
2 pcs



**P4**  
BACK LEG with sticker (L)  
2 pcs

### Hardware List (Two Chairs)



**H1**  
JCBC Bolt  
M6 x 70mm  
16 pcs



**H2**  
Spring Washer  
16 pcs



**H3**  
Flat Washer  
16 pcs



**H4**  
Allen Wrench  
1 pc



**H5**  
Nylon Glide  
8 pcs

If any parts/hardware listed are damaged or missing,  
Please contact the seller for additional assistance



**Best Master Furniture™**  
The Imported Furniture Specialist





## IMPORTANT!

Please keep Allen wrench in a safe place as you may need to tighten up the Bolts in future.

Use a soft cloth between these parts and the floor.

After assembly, item must be level to work properly.

## ASSEMBLY STEPS

H1 x 8	
M6 x 70mm	
H2 x 8	
H3 x 8	
H5 x 4	

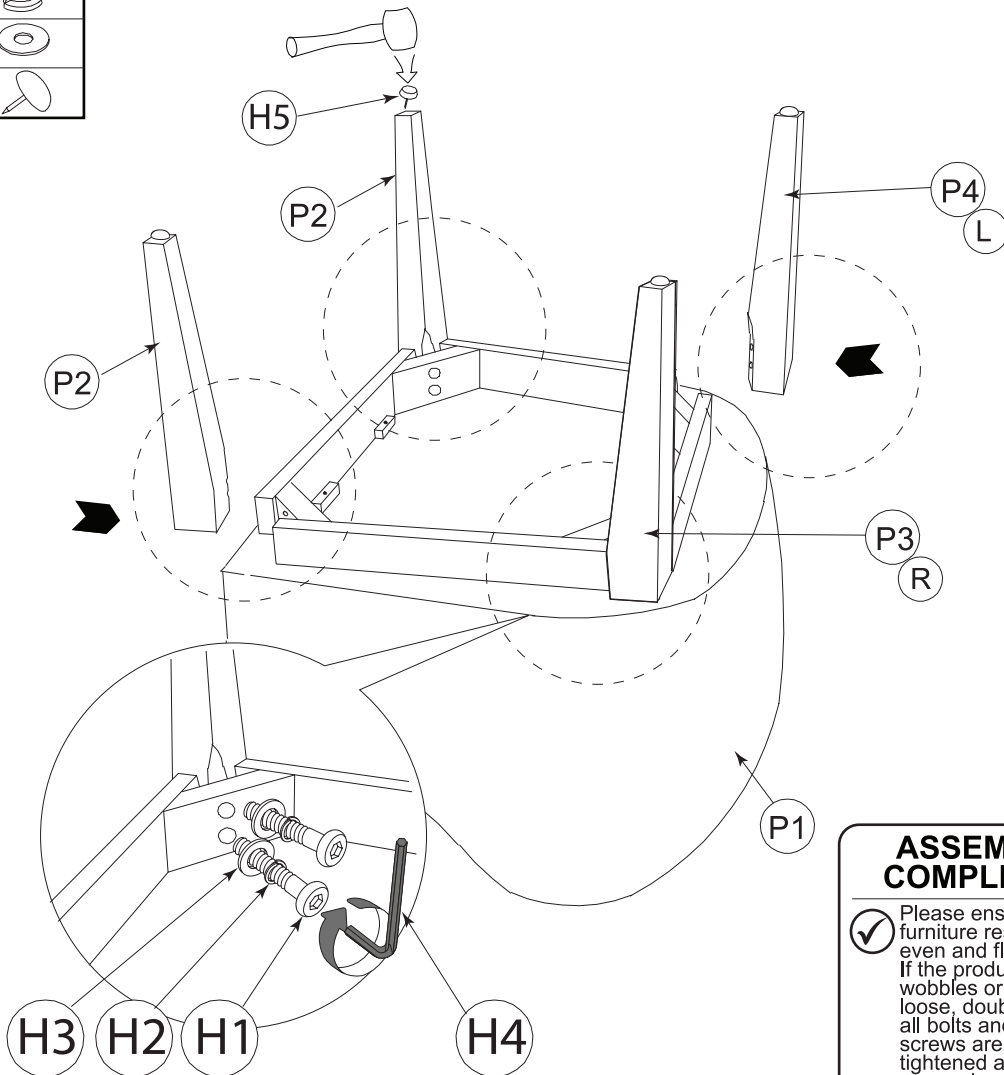

### ASSEMBLY COMPLETED

- ✓ Please ensure the furniture rests on an even and flat surface. If the product wobbles or feels loose, double-check all bolts and/or screws are properly tightened and secured.
- ✓ **Keep this handy!** Please retain this instruction manual and any order-related information for future reference.
- ✓ **Lift, don't drag!** To avoid damage to product, please always LIFT the product when transporting or adjusting the placement.

This product is intended for RESIDENTIAL USE ONLY and not for commercial use.