

Vinyl Fence Panel

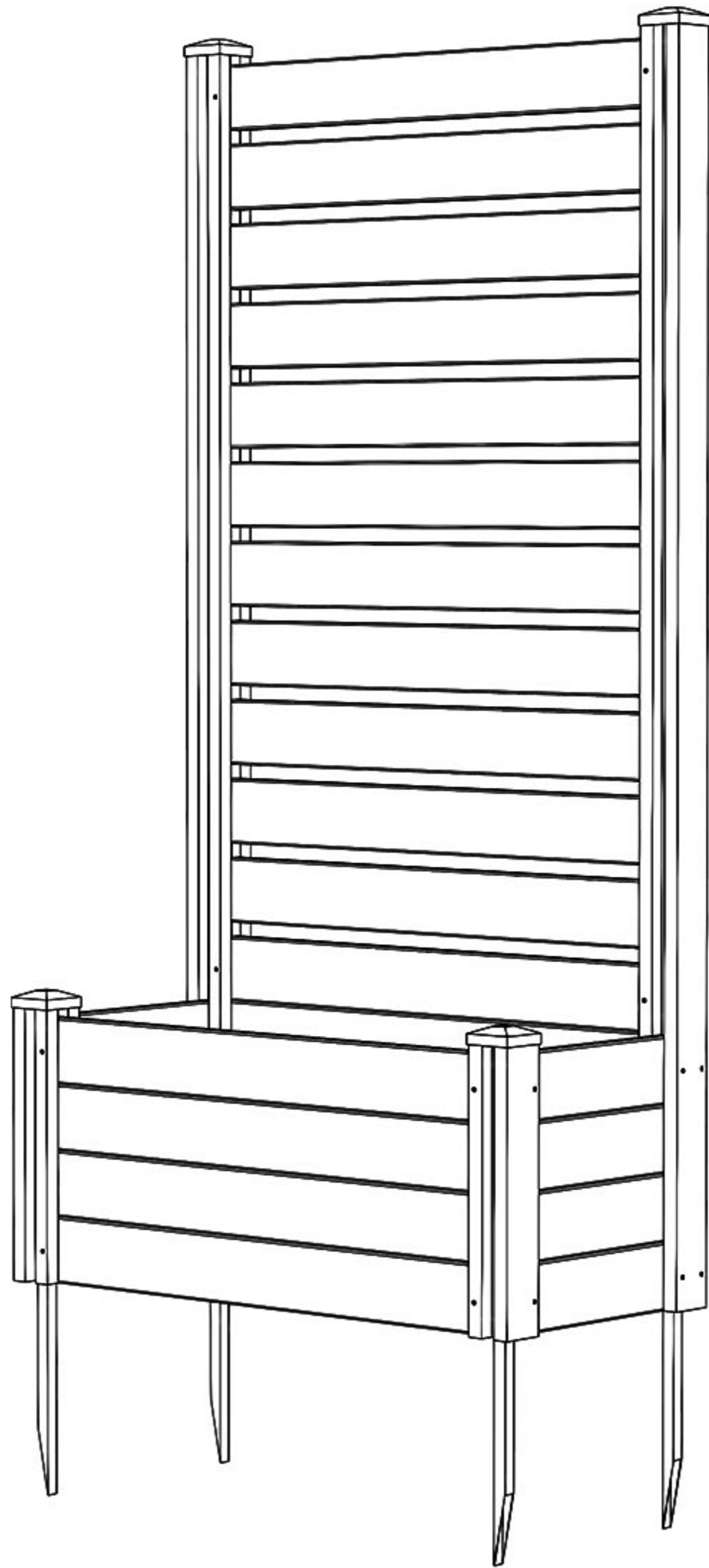

Read the instructions carefully before you begin, familiarizing yourself with every detail and step. Keep this manual for future reference.

Before assembling, we recommend:

1. Wear Gloves.

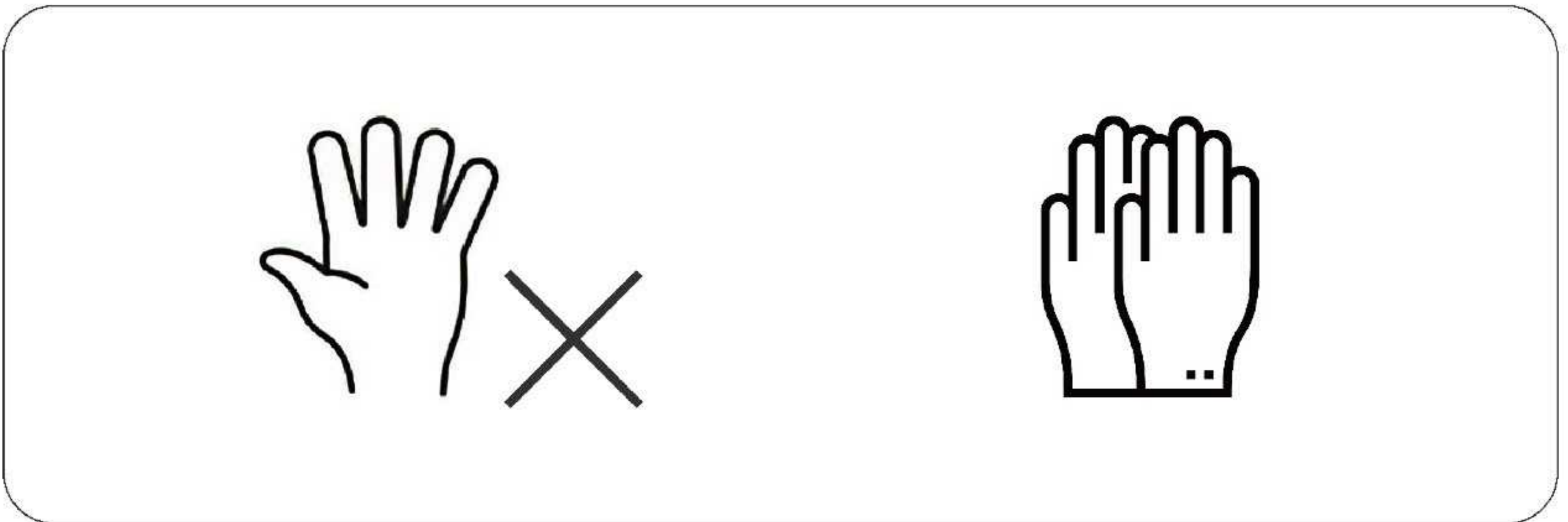

2. Ask for a Helping Hand.

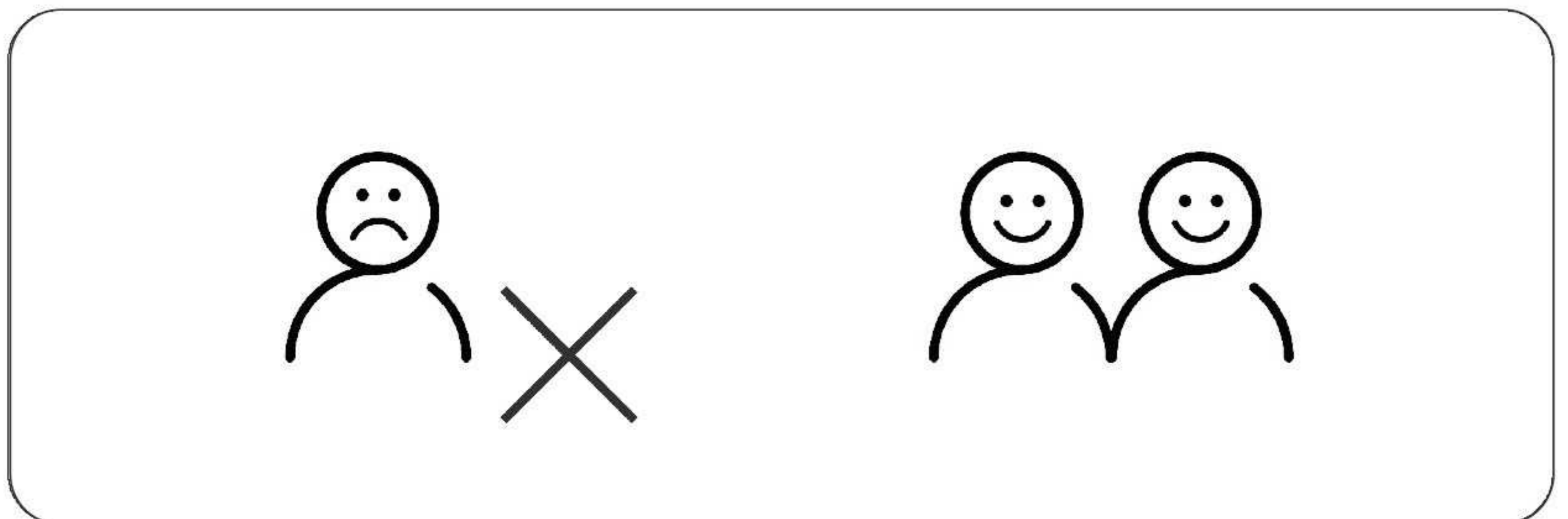



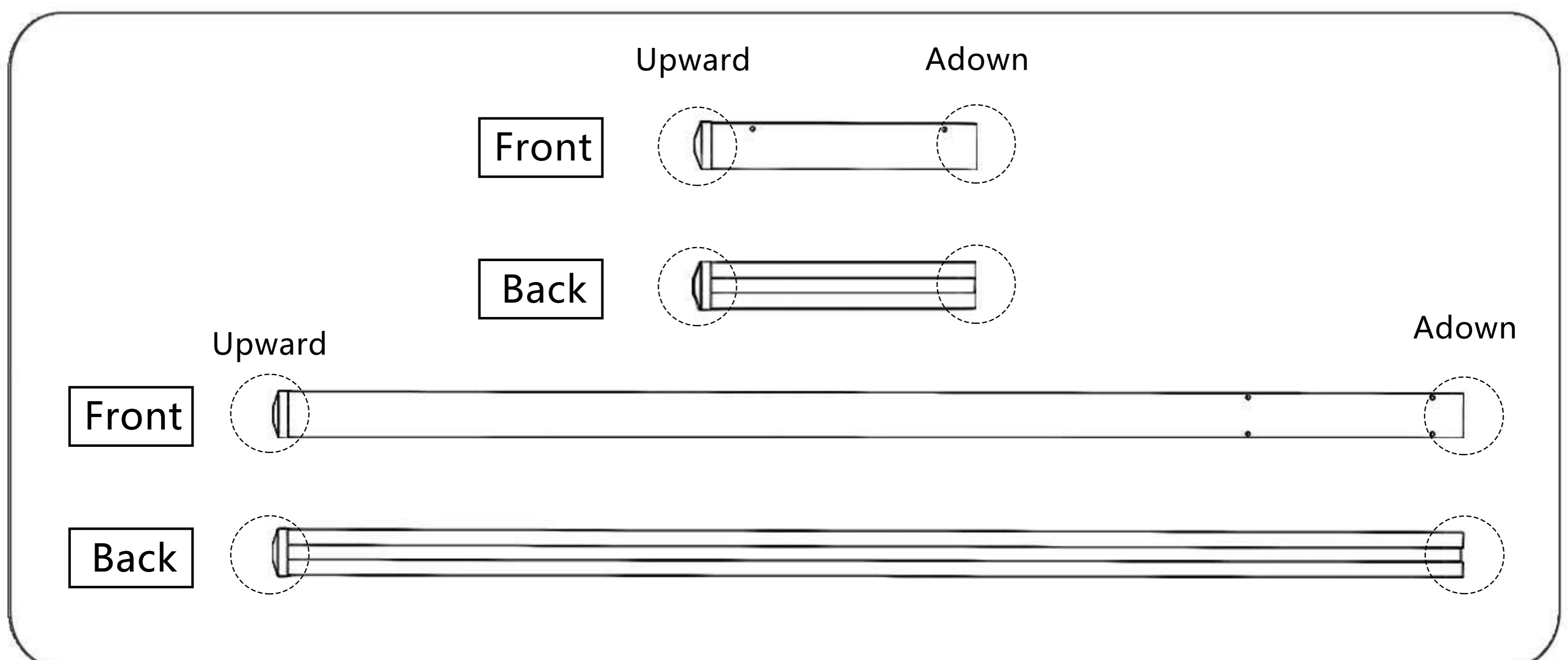

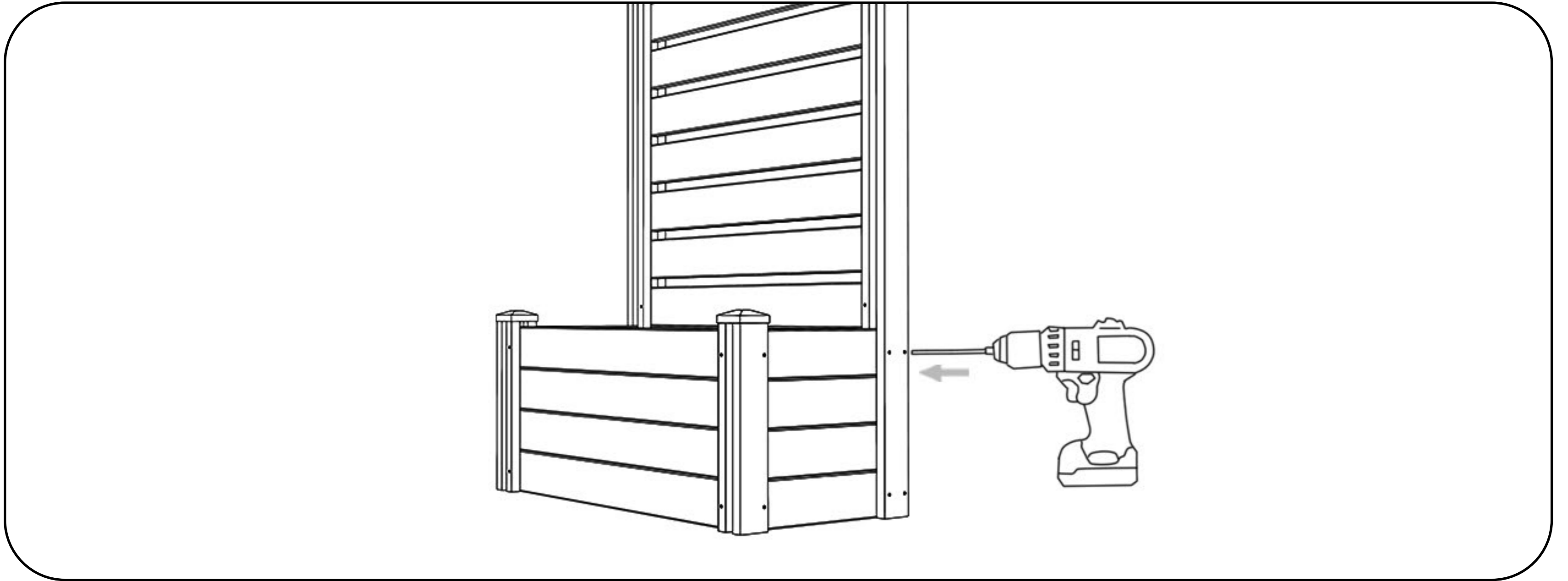

3. Orientation of parts.







4. Prepare an electric drill for drilling.



5. Number of parts

					
(A)	(B)	(C)	(D)	(E)	(F)
1 pcs	1 pcs	1 pcs	1 pcs	4 pcs	24 pcs

				
(G)	(H)	(I)	(J)	(K)
20 pcs	8 pcs	2 pcs	2 pcs	20 pcs

ps:do not tighten the screws yet, tighten them all after installation is complete

Installation Steps

1

Ⓢ X2 ⓐ X2

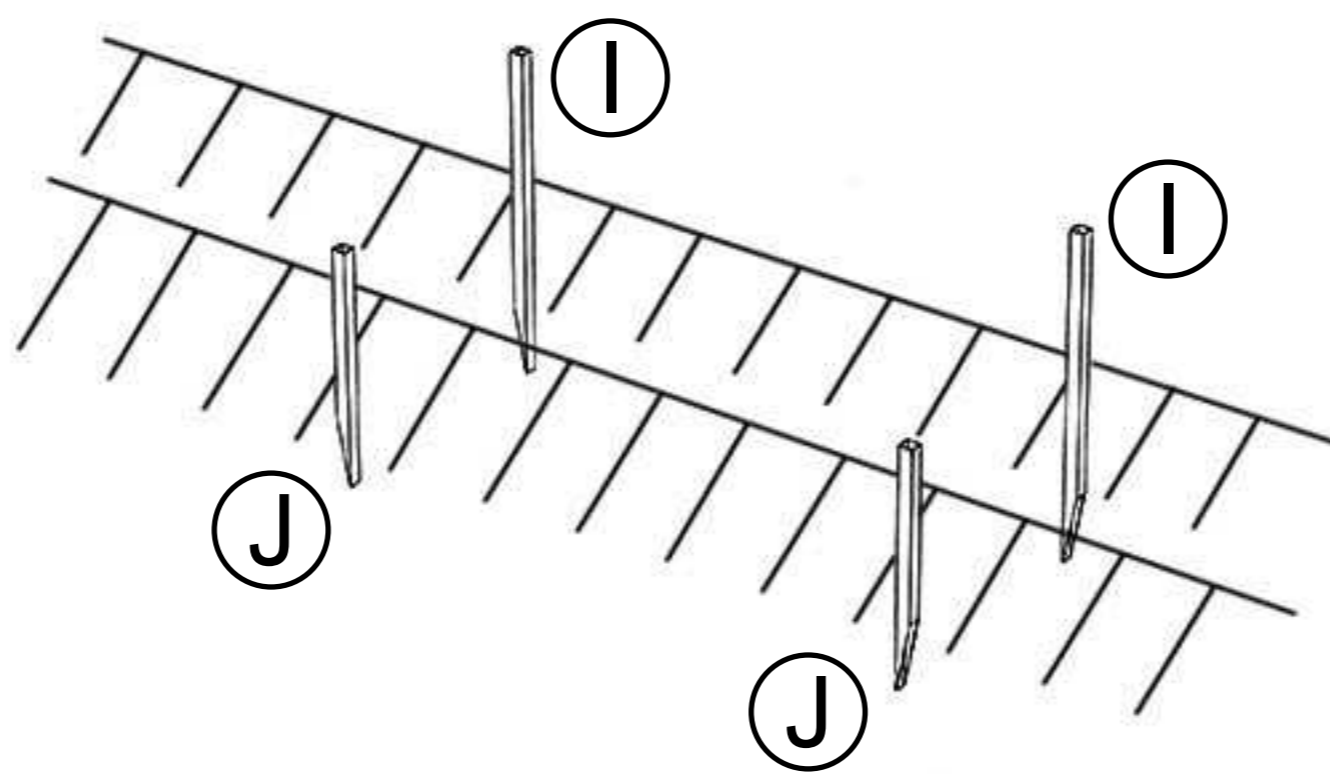
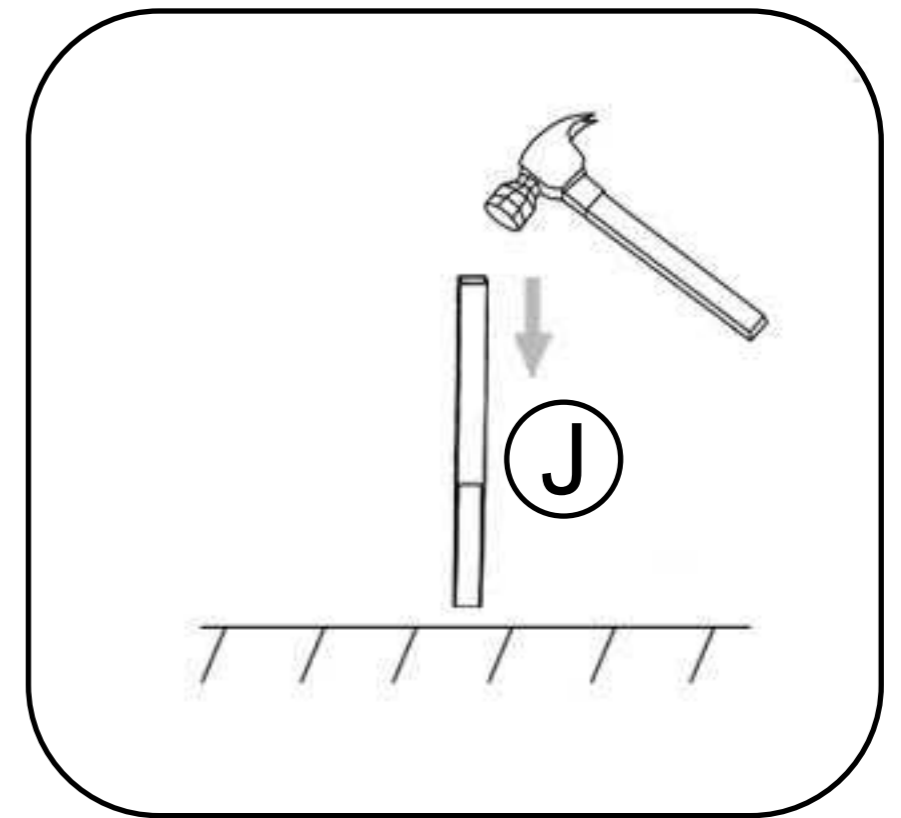
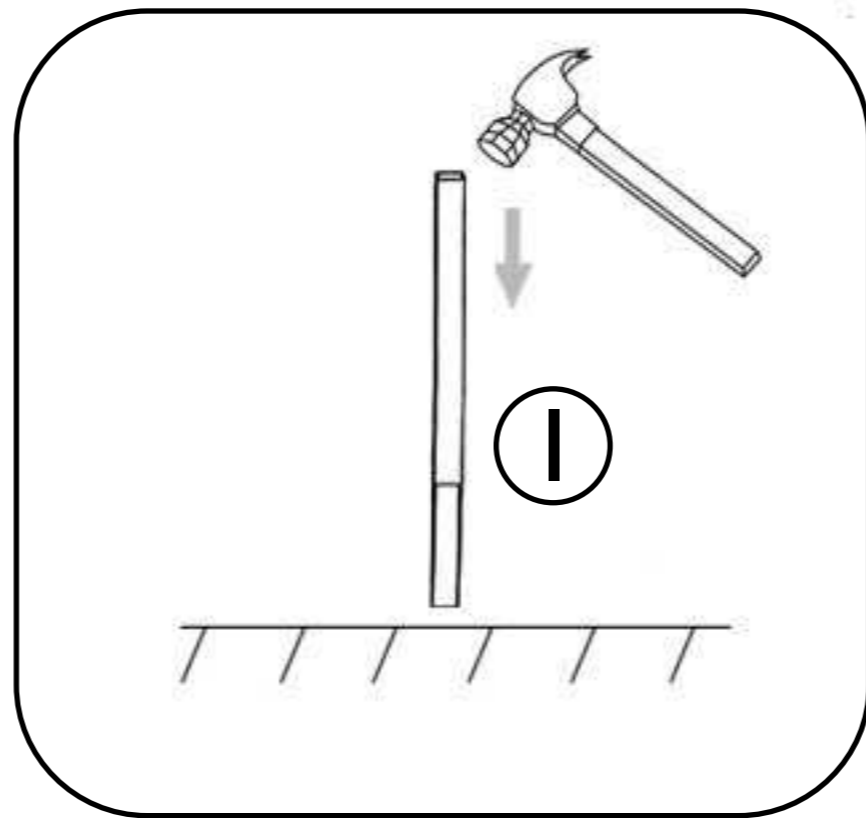

2

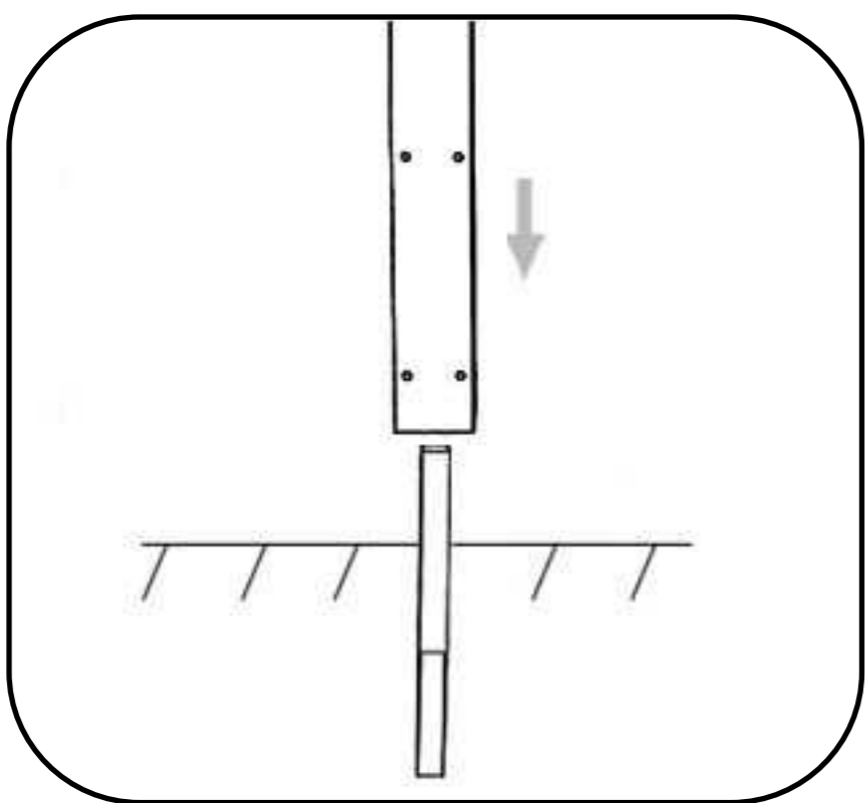

Ⓐ



Ⓑ

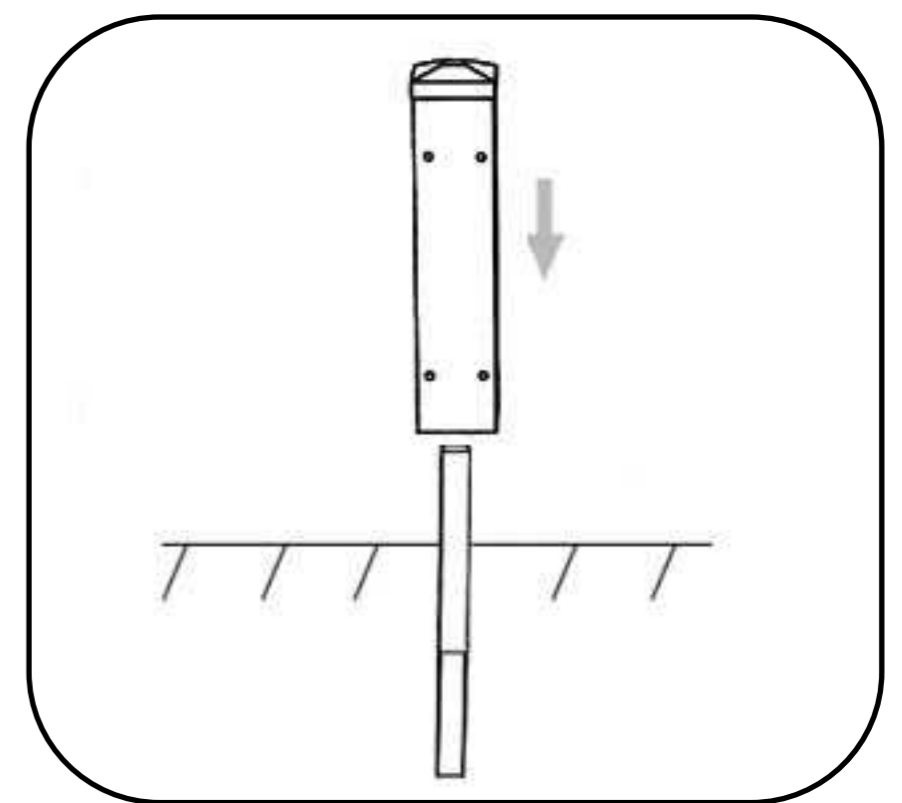

Ⓒ



Ⓓ

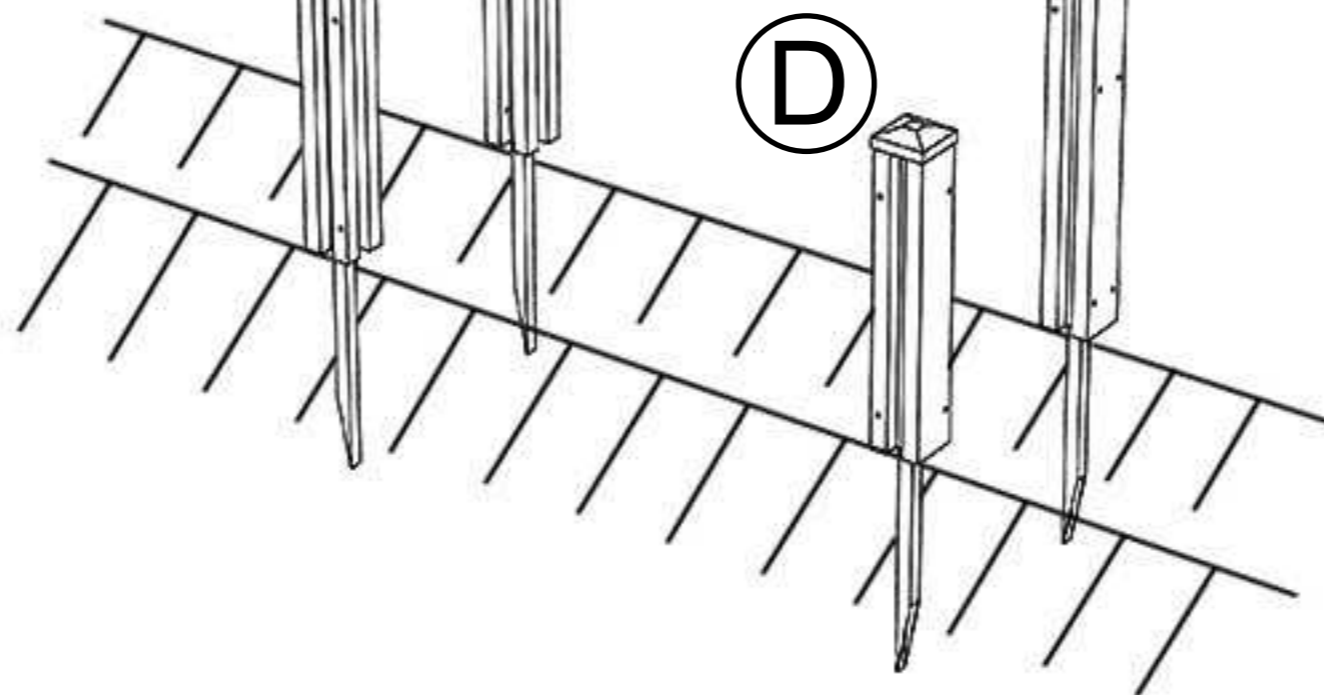

Installation Steps

3 (E) X4

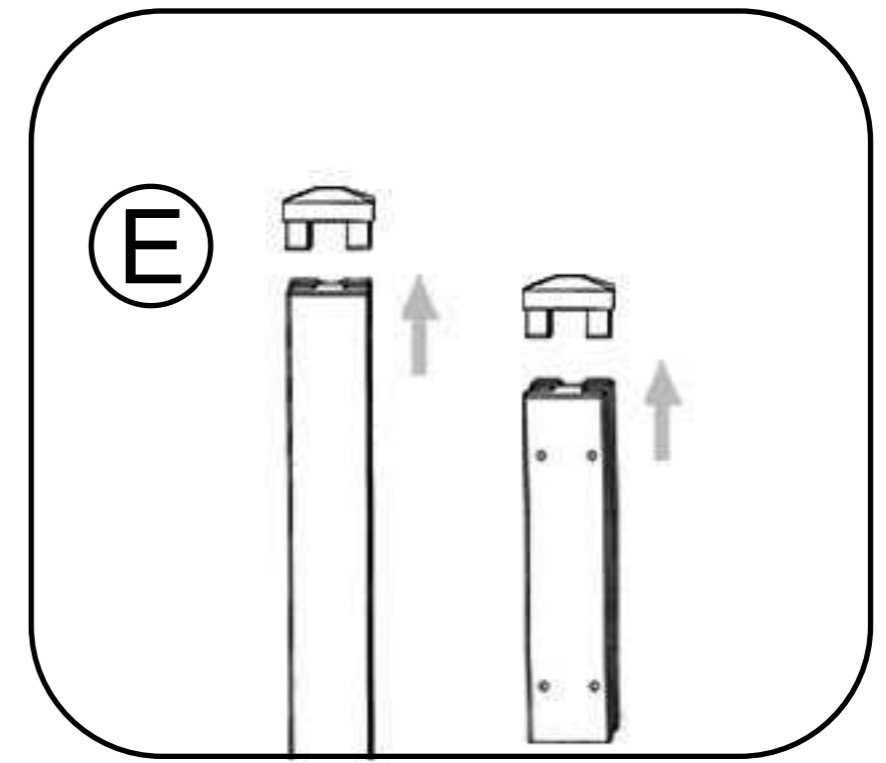
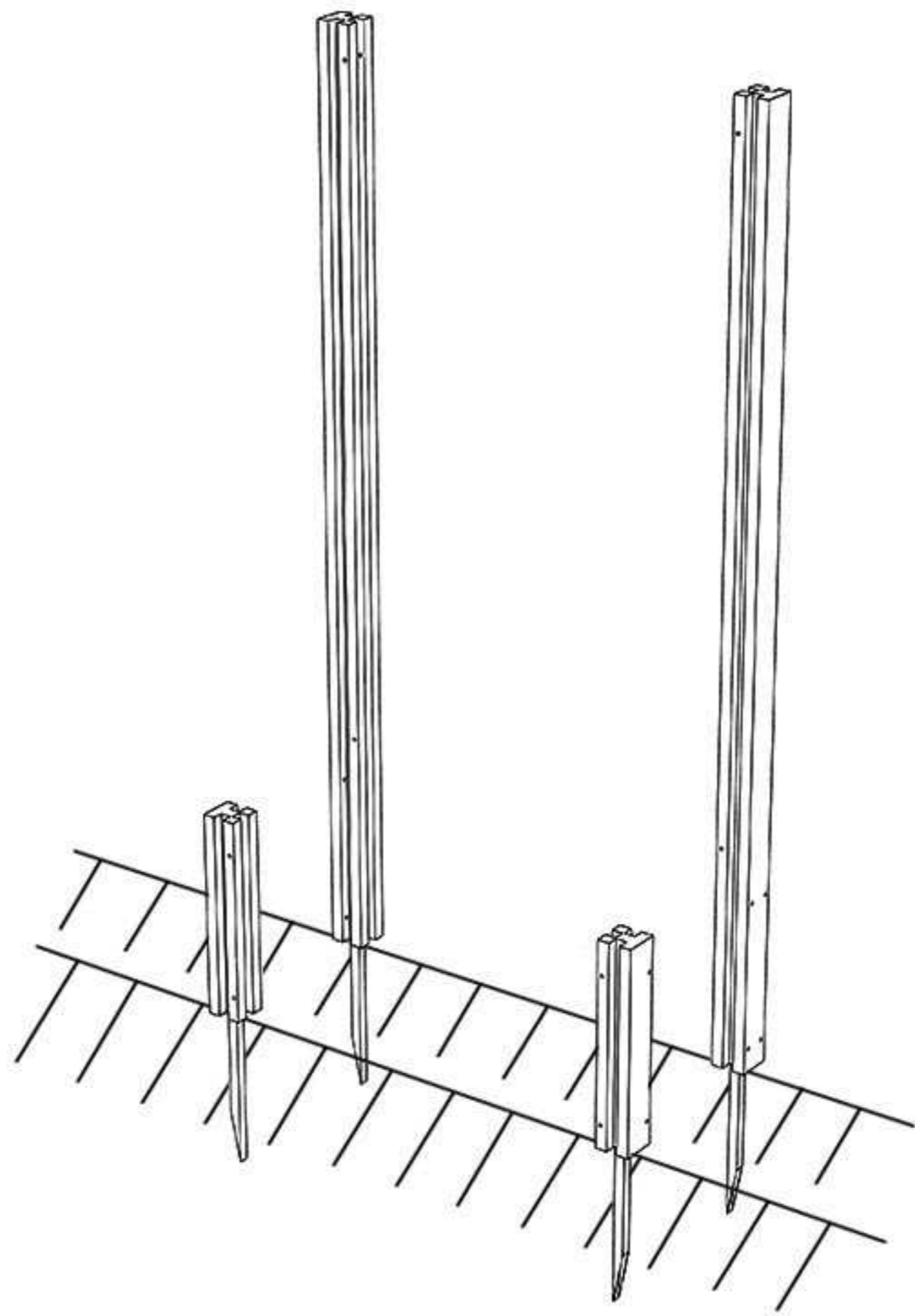

4 (G) X8 (H) X8

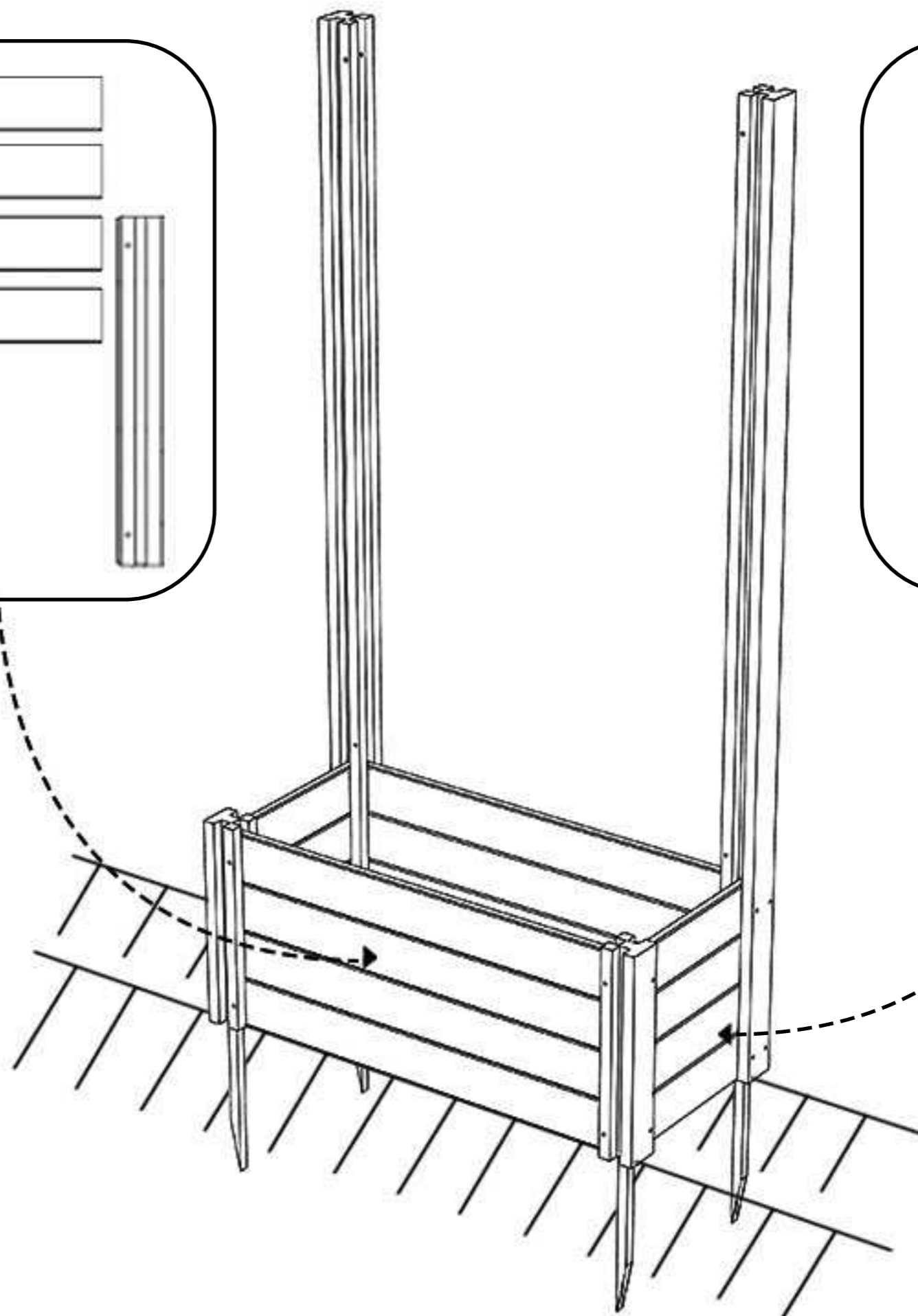
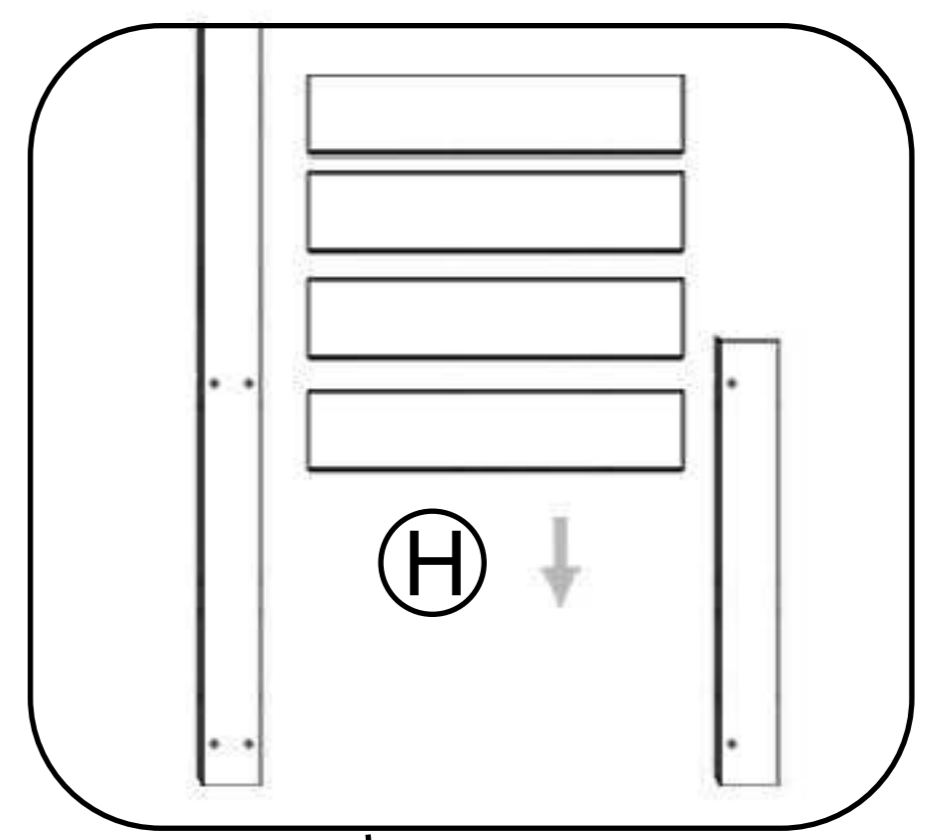
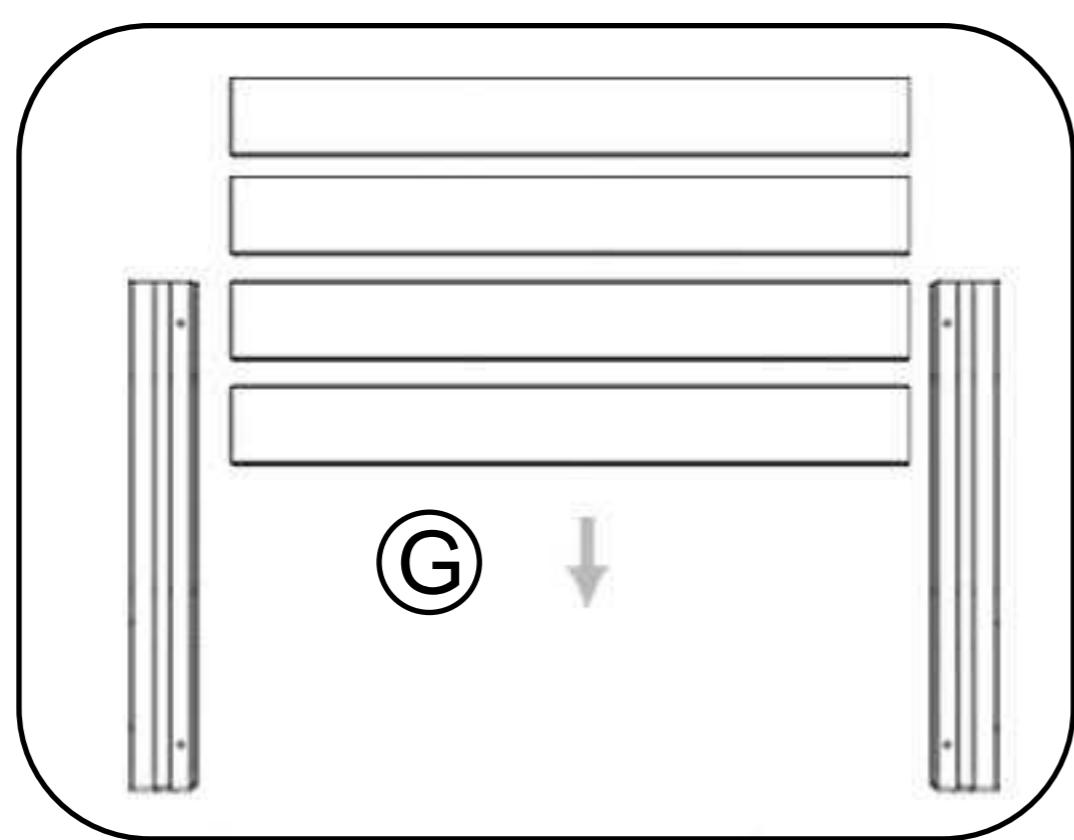

Installation Steps

5

ⓐ X1

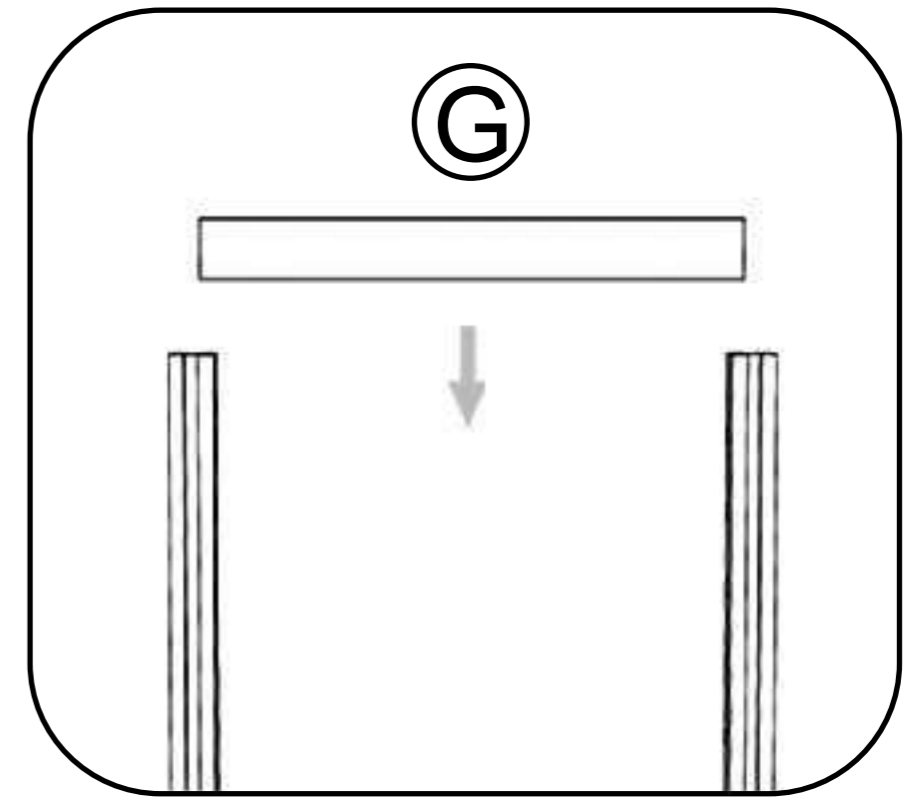
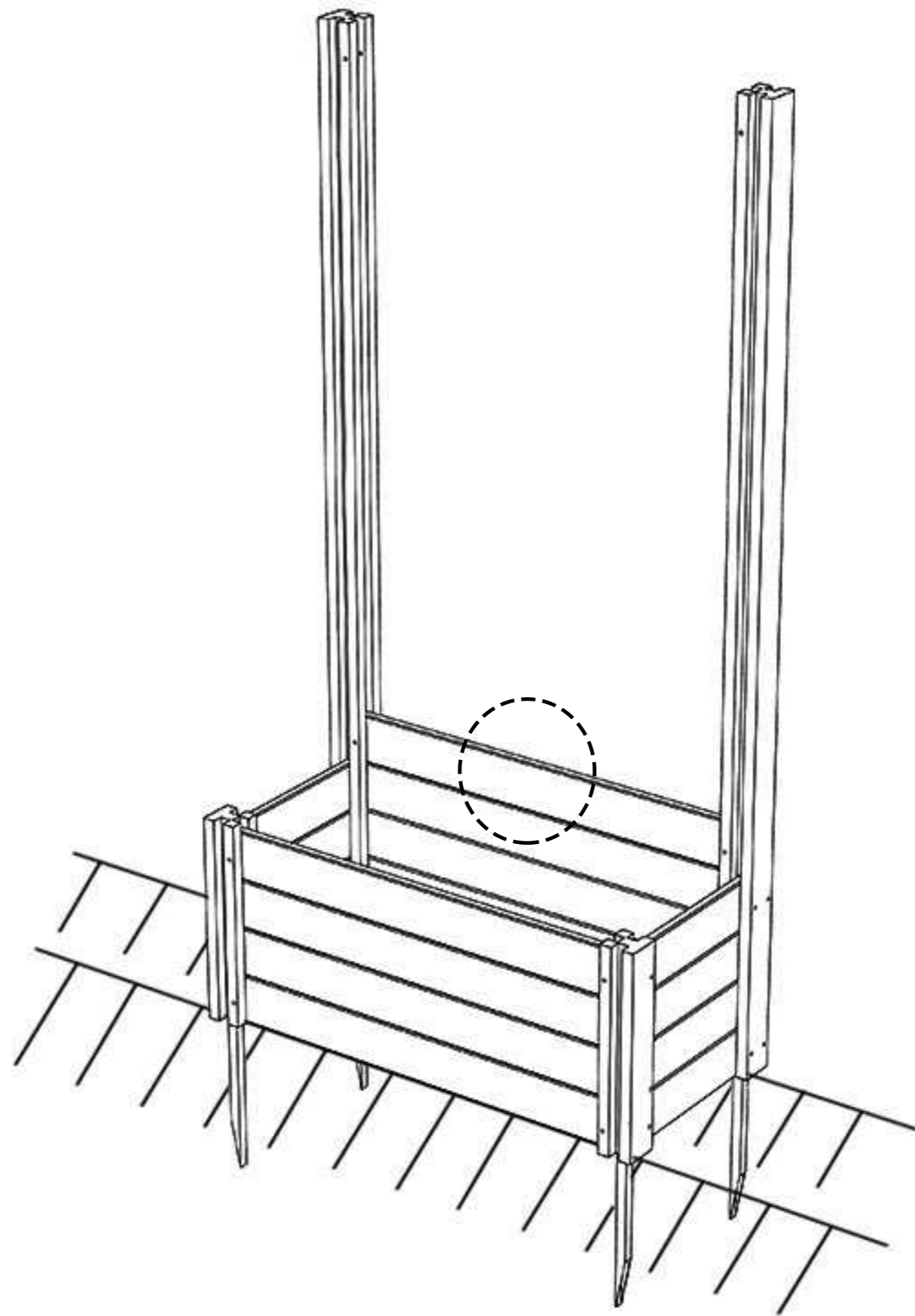

6

ⓑ X2

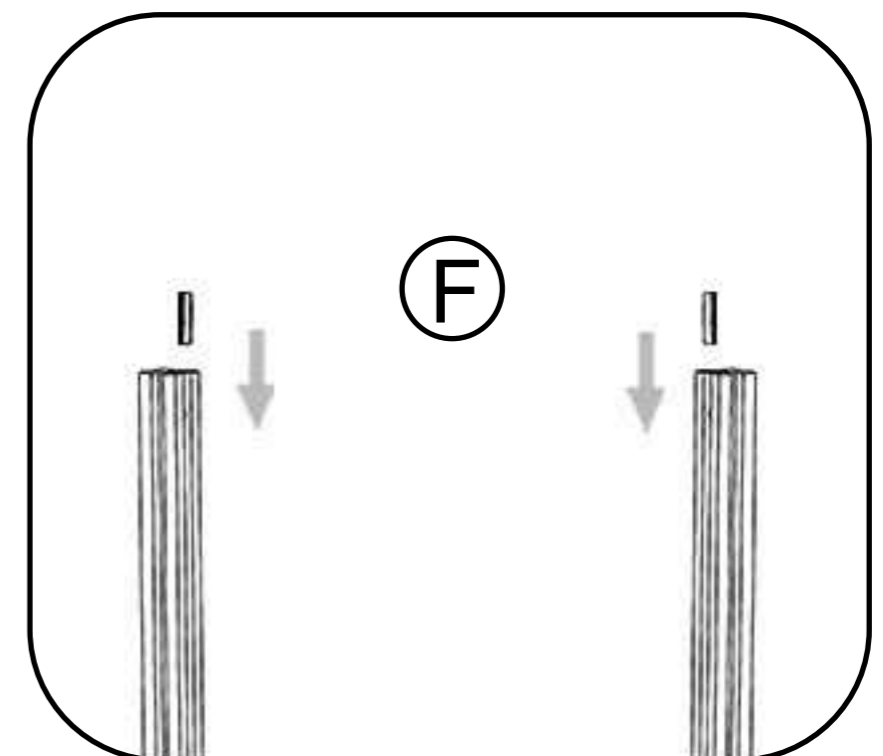
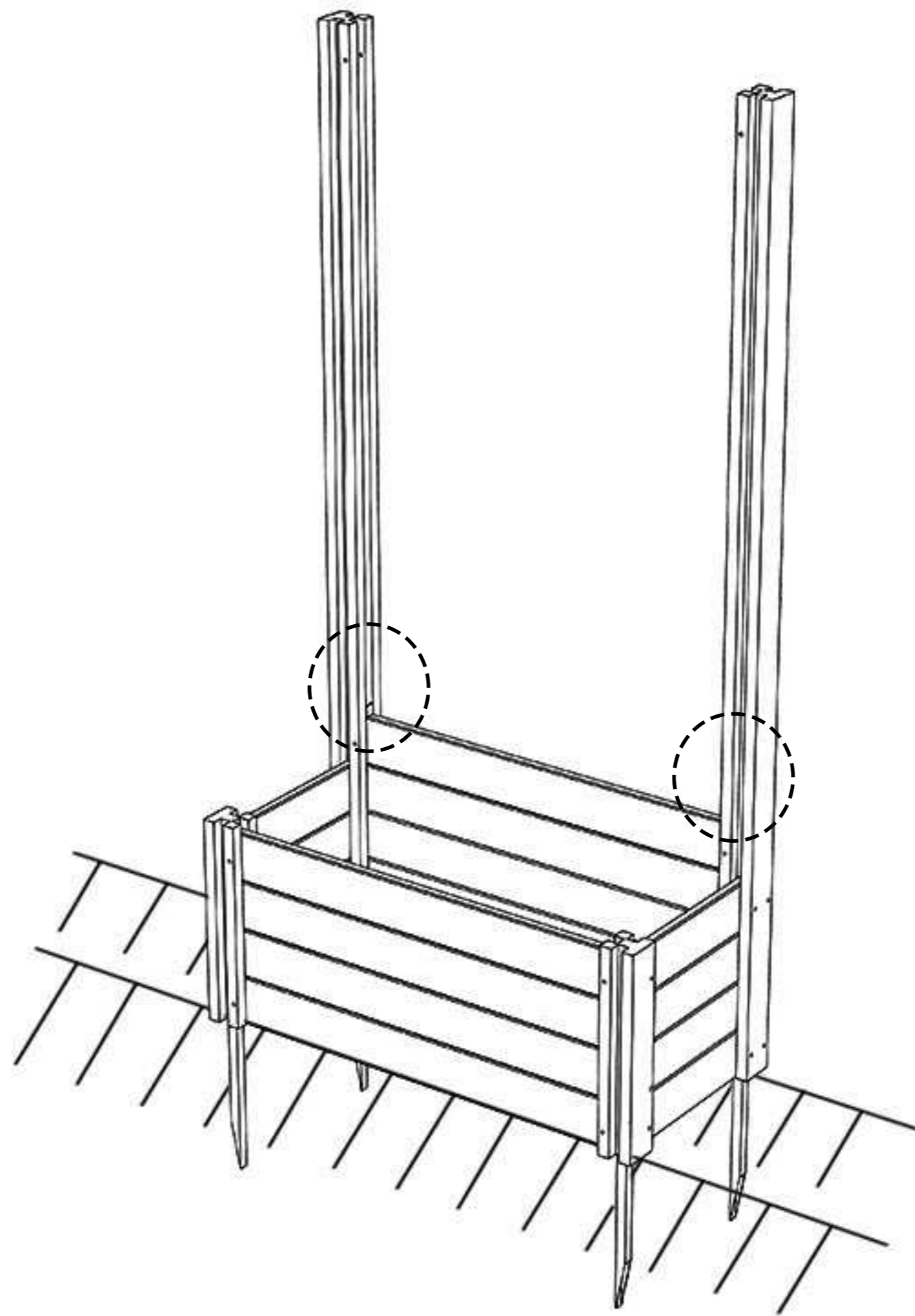

Installation Steps

7

ⓐ X11 ⓑ X20

Repeat steps 7 and 8 eleven times

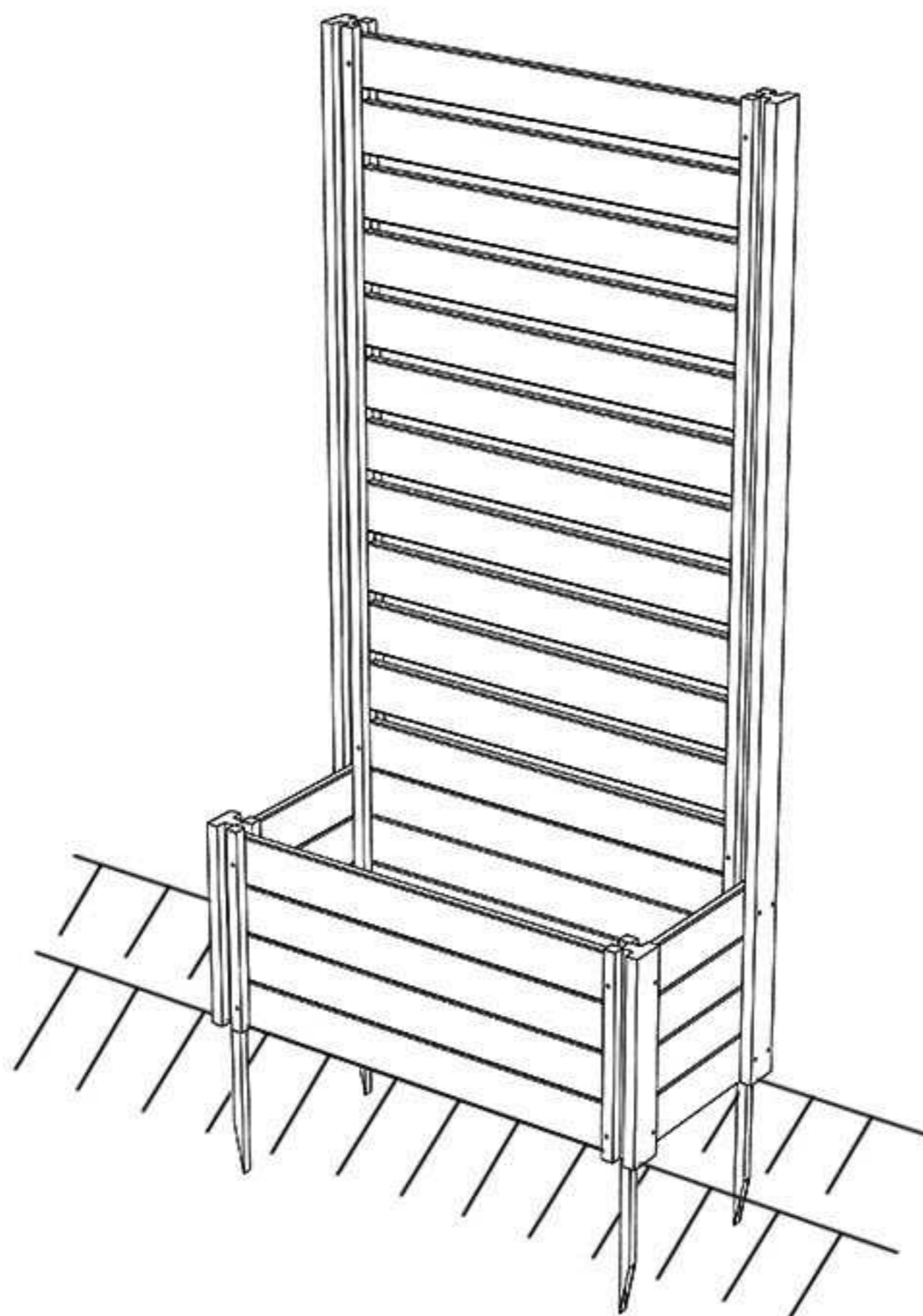

8

Ⓒ X1

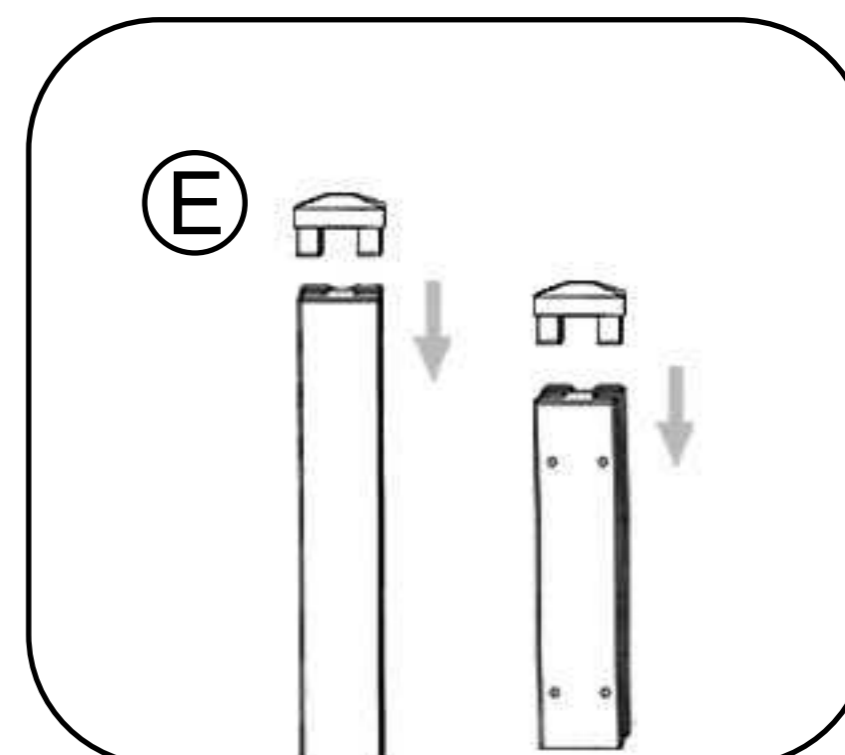
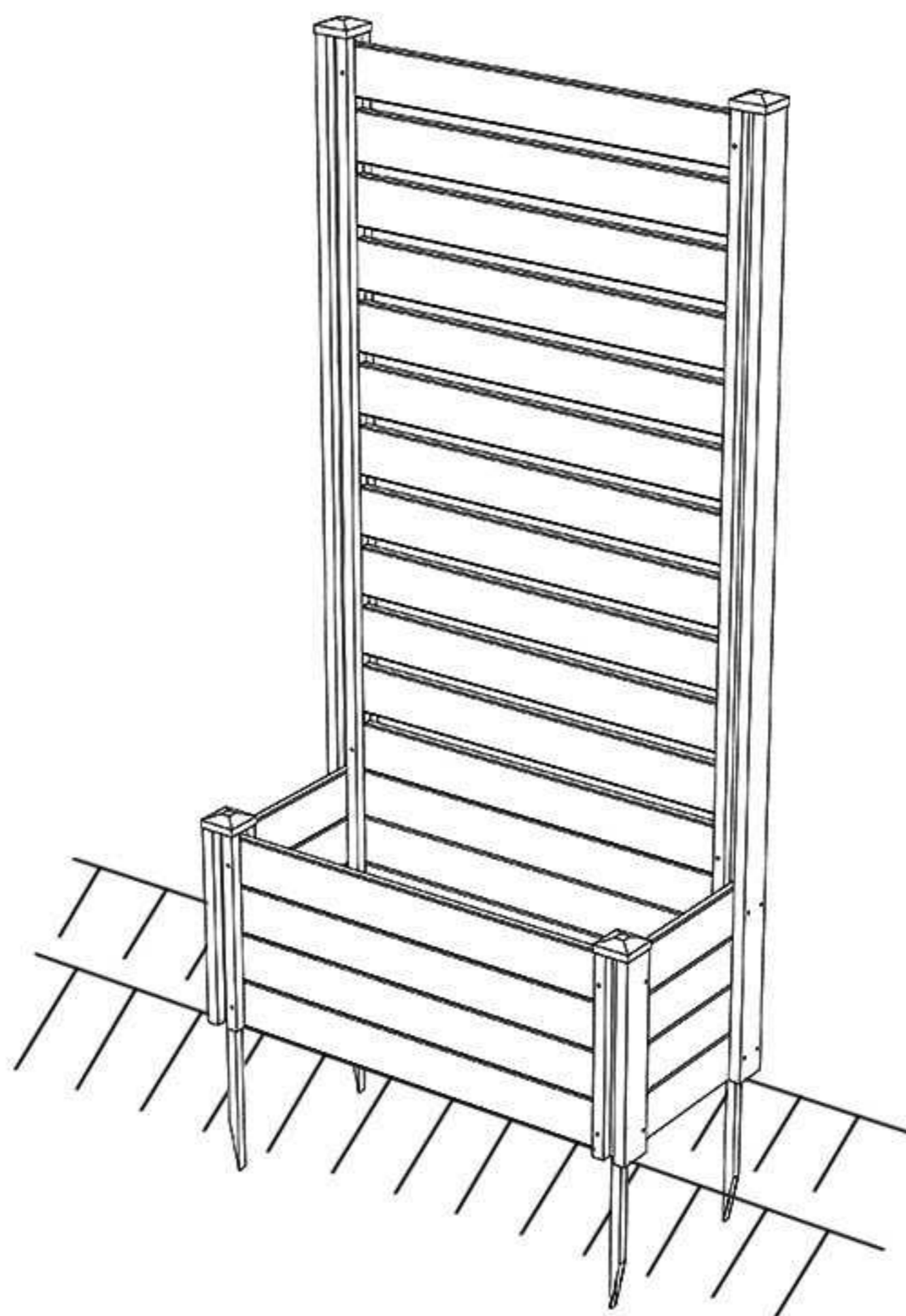

Installation Steps

9

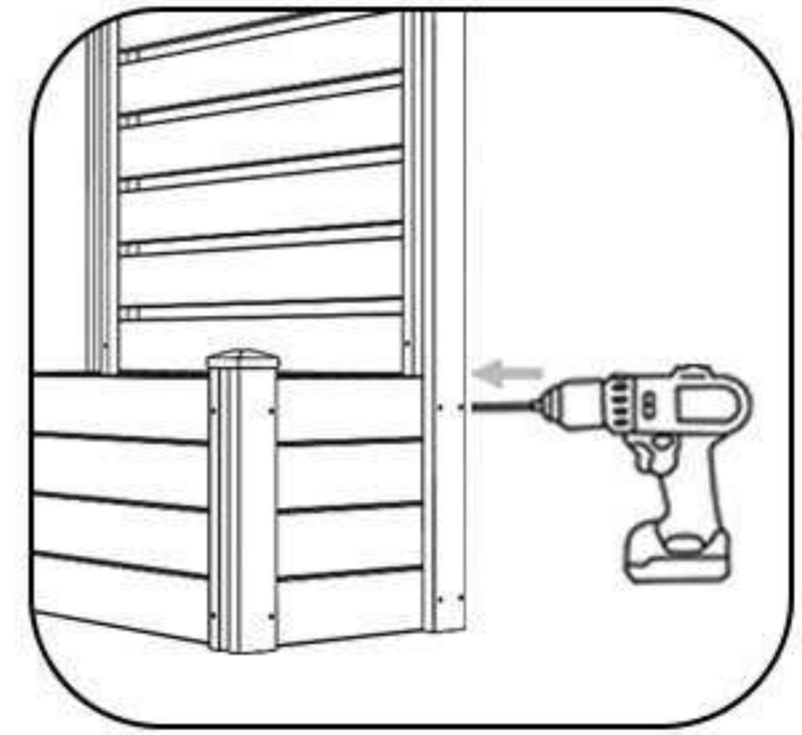
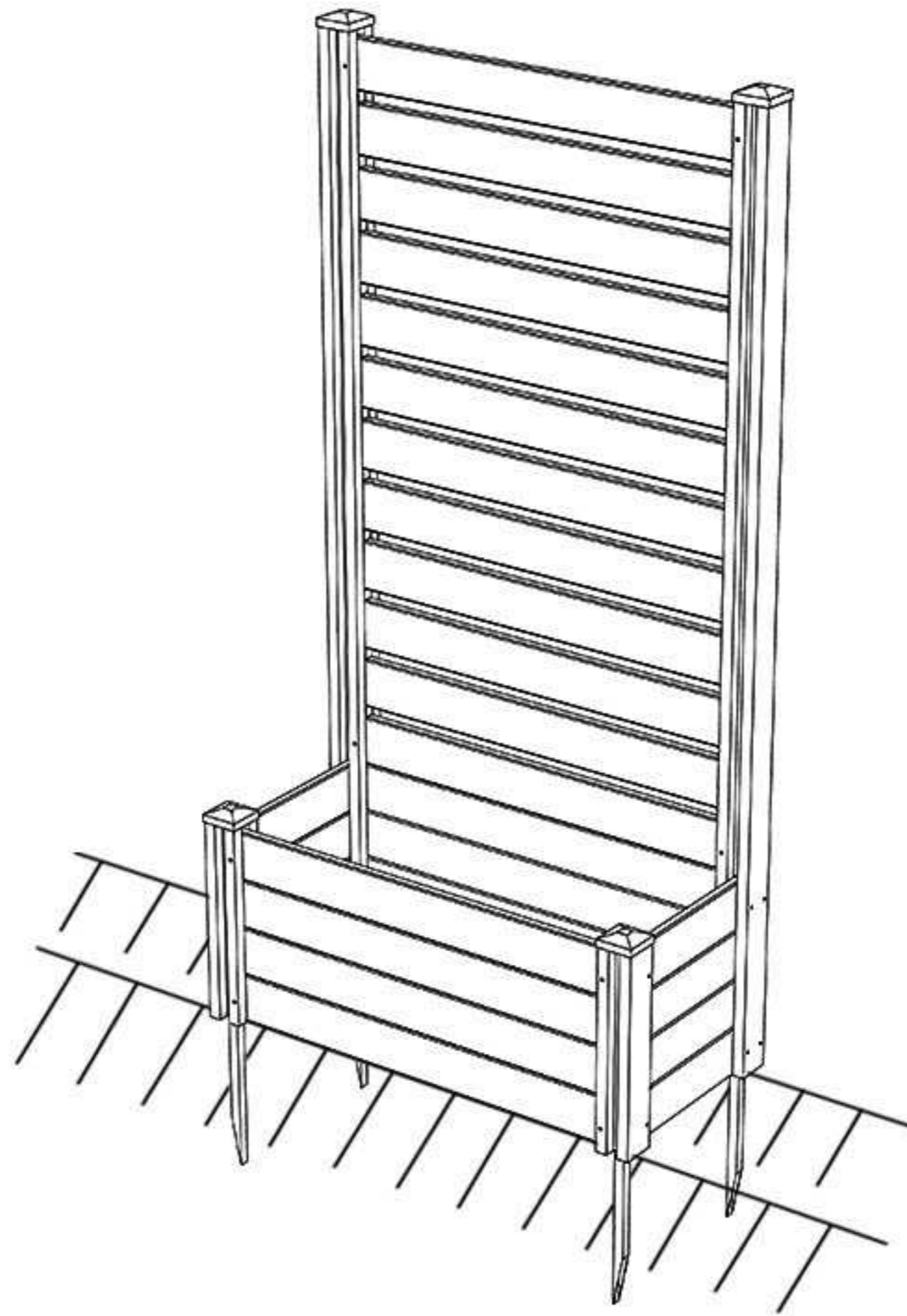

10

Ⓚ X20

