







ASSEMBLY INSTRUCTION

REVERSIBLE SOFA CHAISE

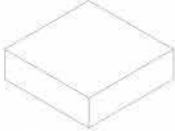

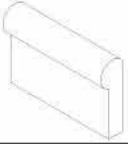
Please find hardware and parts packed inside the sofa seat and ottoman.

NOTE: Do not use power tools for assembly. Power tools increase the risk of over tightening which lead to splitting or cracking the wood.

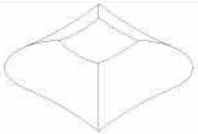
NO.	DRAWING	QTY	DESCRIPTION
A		1	SEAT
B		1	OTTOMAN
C		1	RSF ARM
D		1	LSF ARM
E		1	BACK REST
F		2	LSF&CENTER SEAT CUSHION
G		1	RSF SEAT CUSHION
H		2	PILLOW

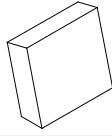
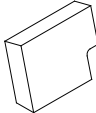
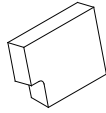
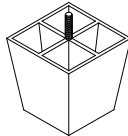
NO.	DRAWING	QTY	DESCRIPTION
I		1	CENTER BACK CUSHION
J		1	RSF BACK CUSHION
K		1	LSF BACK CUSHION
L		8	PLASTIC LEG 110x100x100mm

STEP 1: Release the Velcro and take out the parts inside the frame as shown in drawing for assembly.

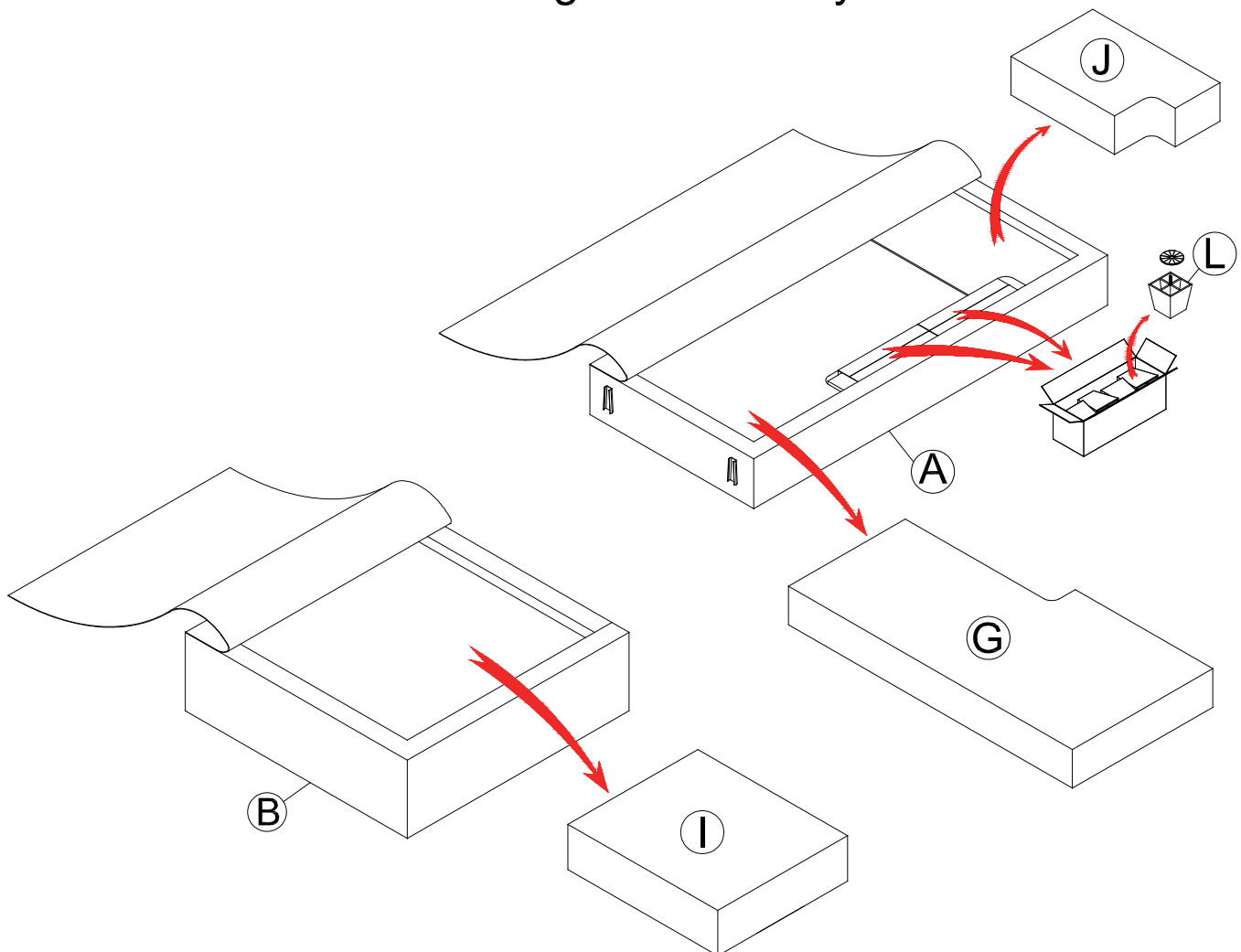

STEP 2: Parts as shown in drawing are placed on the seat frame for assembly.

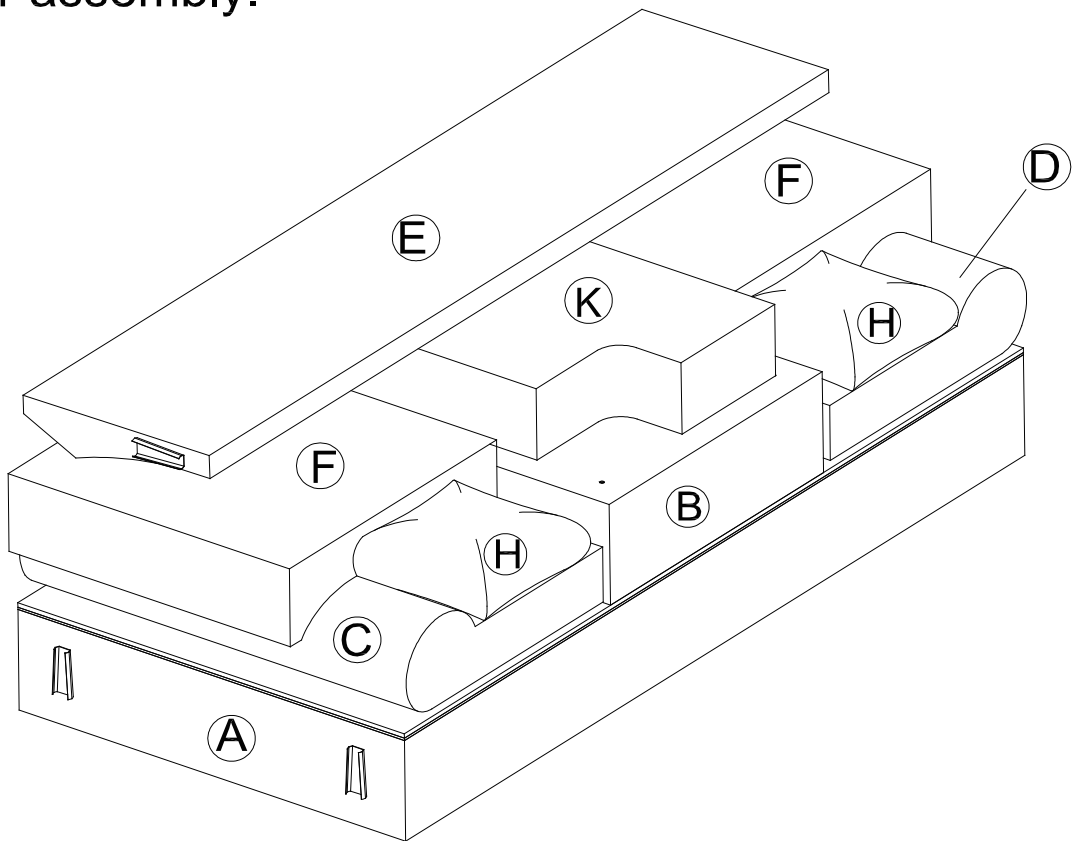

STEP 3:

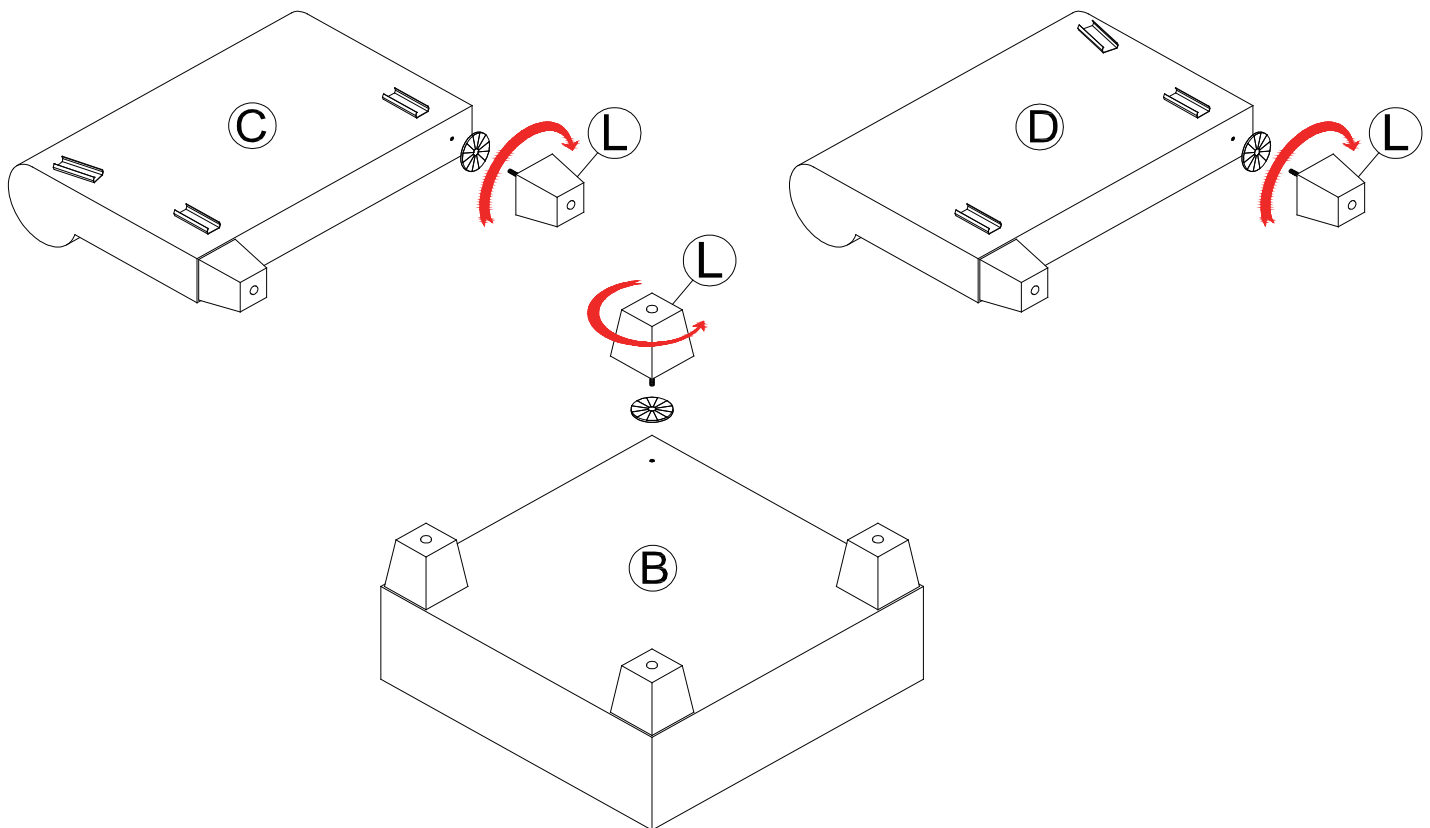

STEP 4:

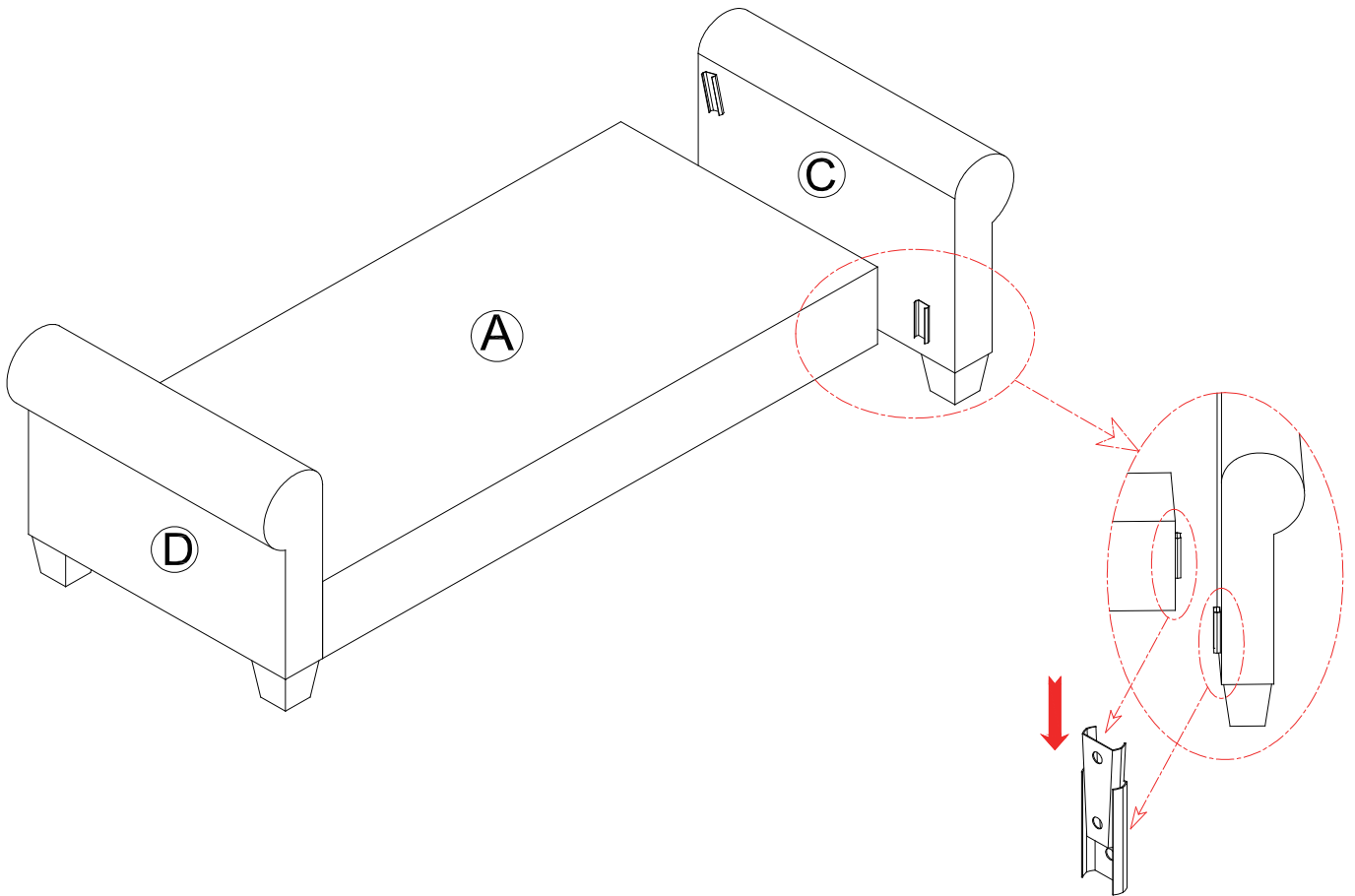

STEP 5:

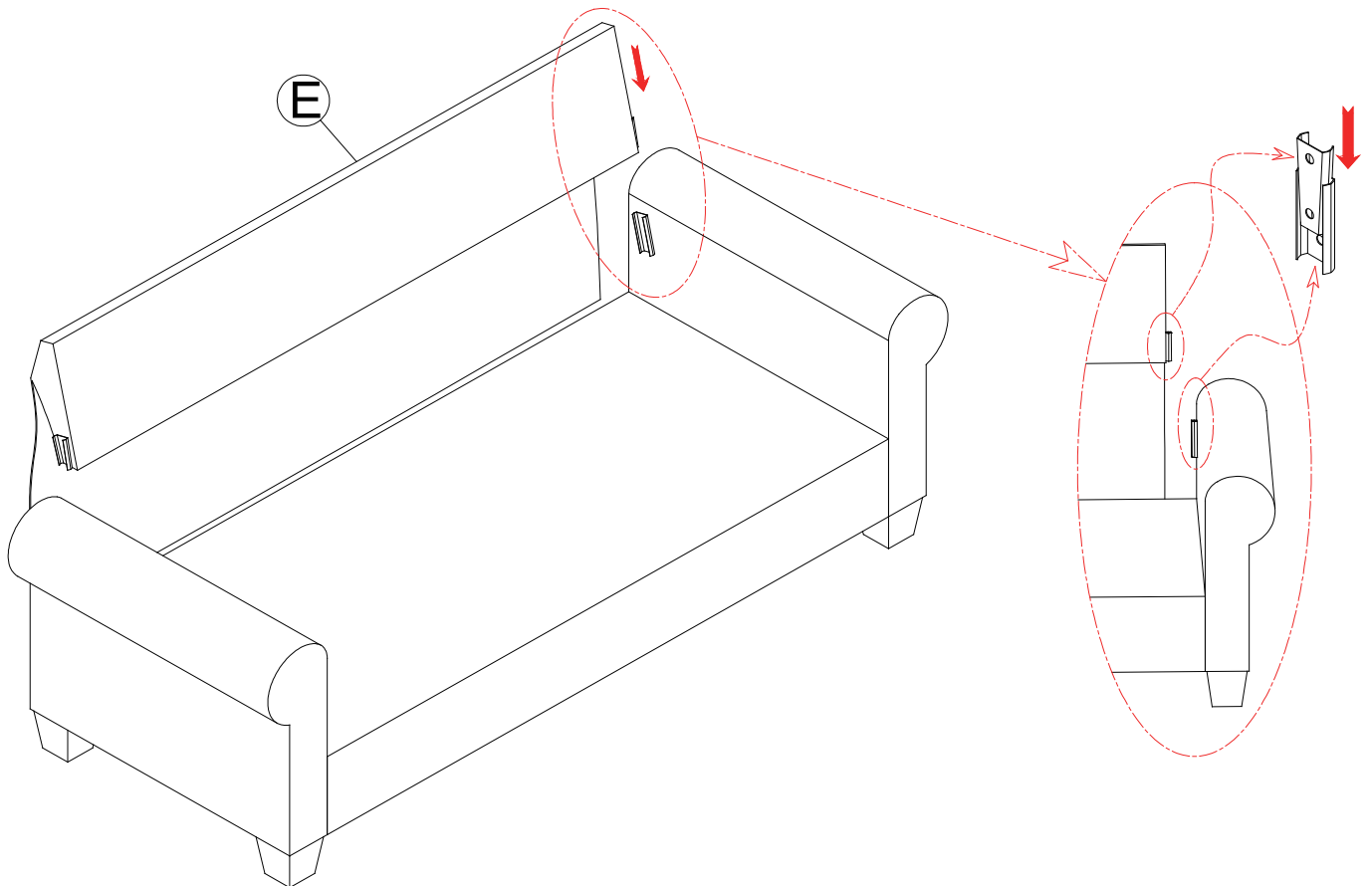

STEP 6:

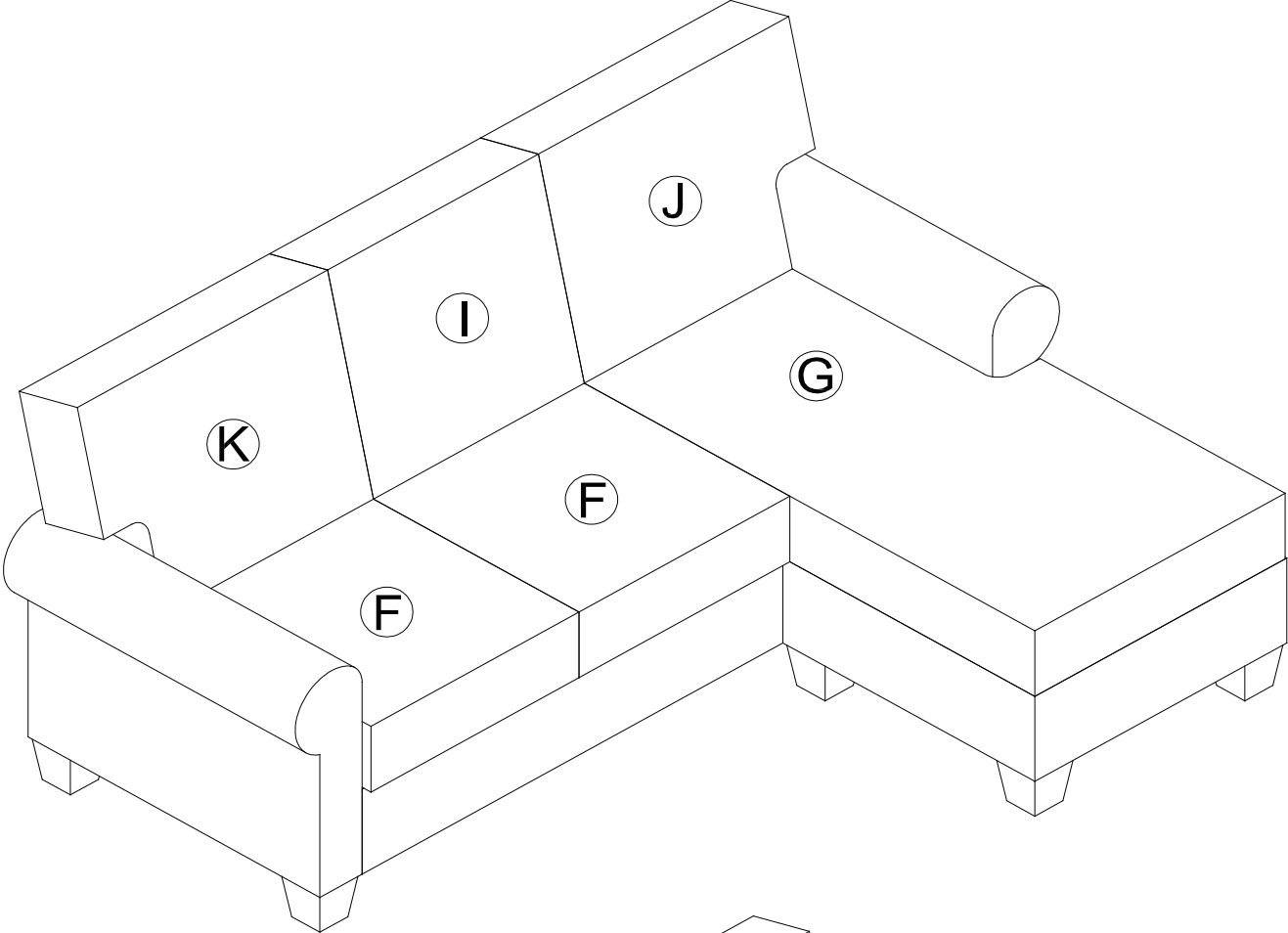

COMPLETE

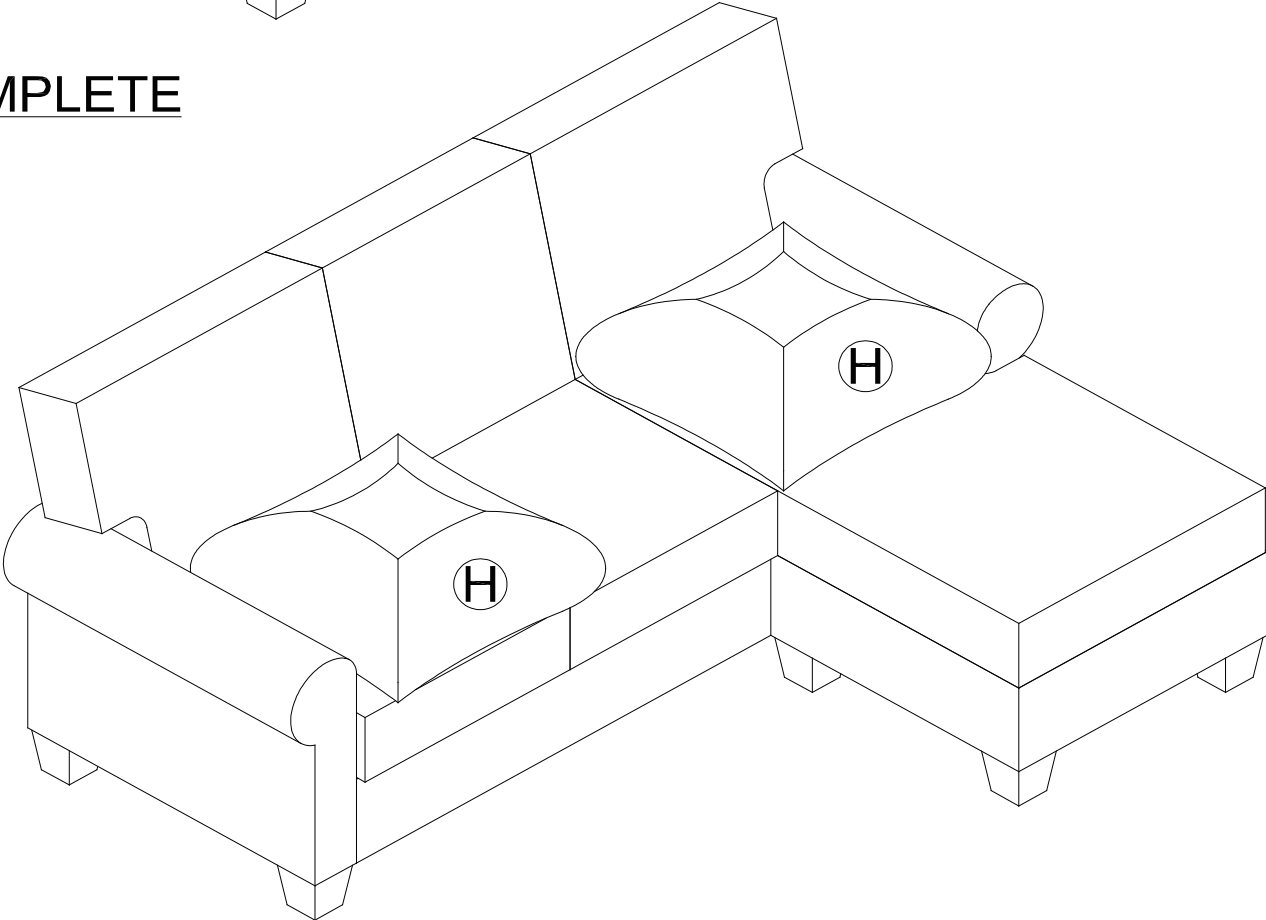

Care instruction for chenille furniture:

In order to maintain the original appearance of your chenille furniture, please follow below simple care procedures:

- Avoid exposing furniture directly to sunlight or heating or heating conditioning outlets. Sunlight and or exposure to heating and air conditioning outlets will fade/damage chenille.
- Do not place your upholstered furniture too close to windows, radiators, or vents, and be sure to use windows, radiators, or vents.
- Vacuum or wipe with a cloth regularly to remove dust.



For items used on wooden floor, hard surfaces or carpets, it is recommended to install protective pads under all legs and supports to avoid/prevent from damages/scratches and discoloration.