

ASSEMBLY INSTRUCTION

NIGHTSTAND





15 min

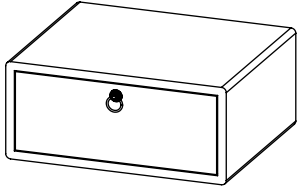
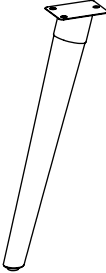

Thank you for purchasing this quality product. Be sure to check all packing material carefully for small parts which may have come loose inside the carton during shipment. Identify and count all parts and compare with the parts list below.

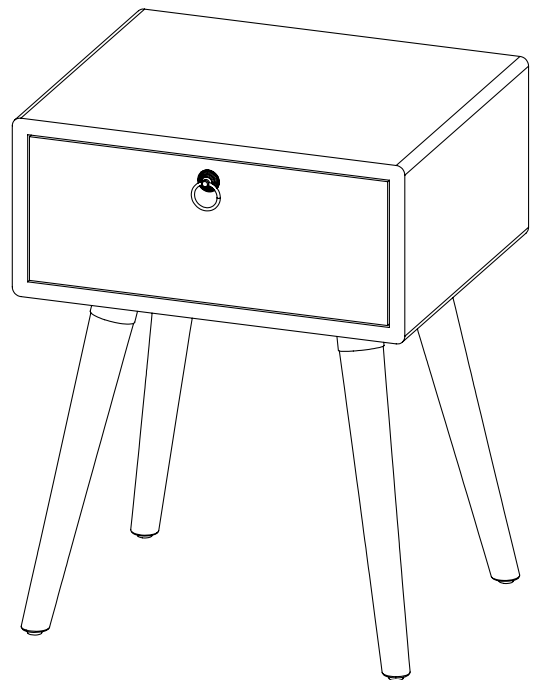

1	NIGHTSTAND		1 PC
2	LEG		4 PCS

A	M6 x 15		12 PCS
B	2 x Ø6.5 x Ø19		12 PCS
C	ALLEN KEY		1 PC



NOTICE: DO NOT use the power tools for assembly.
This can cause the bolts to be over tightened.
DO NOT over tighten hardware, damage may occur.

STEP 1

A	M6 x 15		12 PCS
B	2 x Ø6.5 x Ø19		12 PCS
C	ALLEN KEY		1 PC

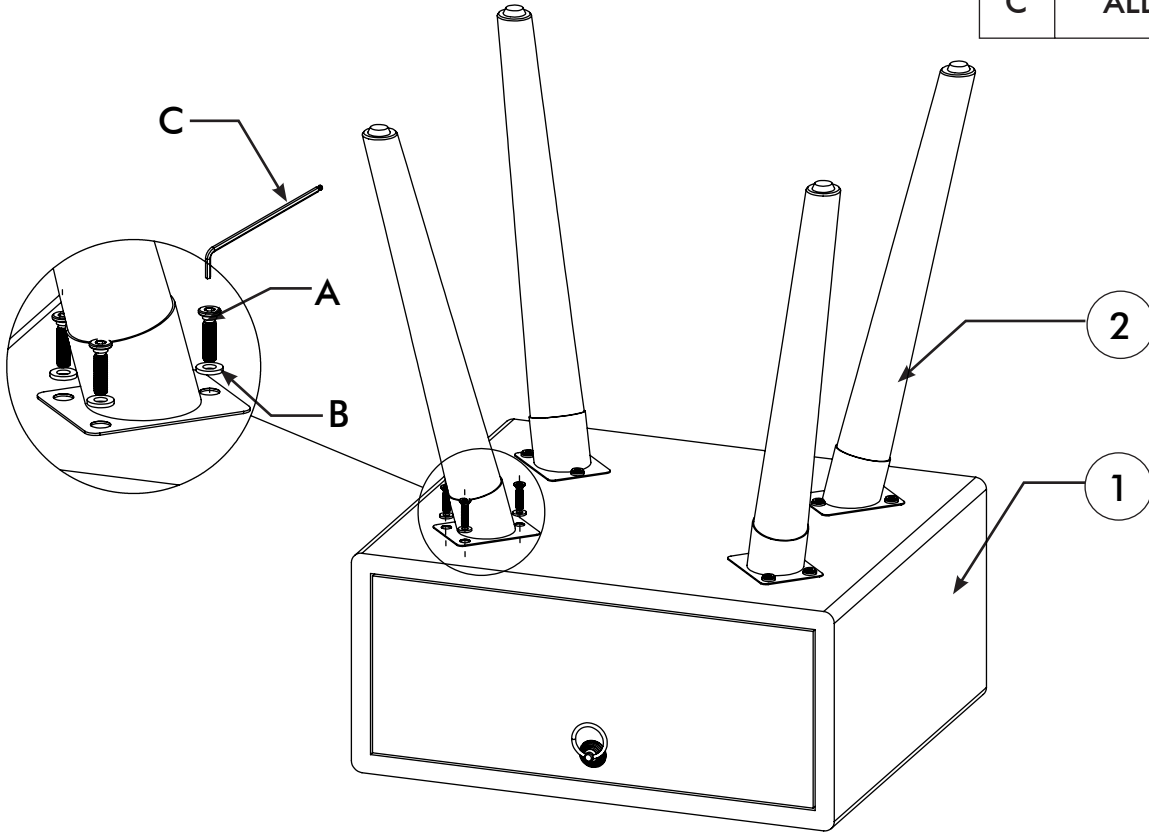

Notice: Make sure the leg is close with wooden frame before assembling.

STEP 2

