

ASSEMBLY INSTRUCTION



This instruction booklet contains important safety information. please read and keep for future reference.

This sofa collection work as modular sofa function,it can be a single sofa, 2seater sofas,3seater sofas,sofa sets with buying different sections of the sofas and combine them together.You can decide to buy more components according to your living room size.

To ensure safe and satisfactory use of this product,please carefully read the below instructions beforehand.

1.This sofa ships in several boxes,we recommend unpacking and starting assembly when several boxes are received.

2.In the event that a part is damaged or missing,no need to return the product,we will gladly help and ship your replacement parts free of charge.

Below are some guidelines for you how you can do mix and match.

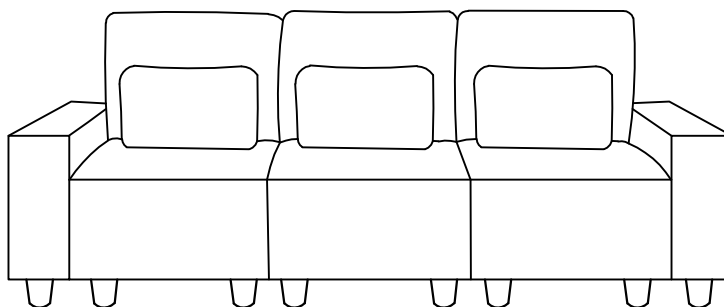
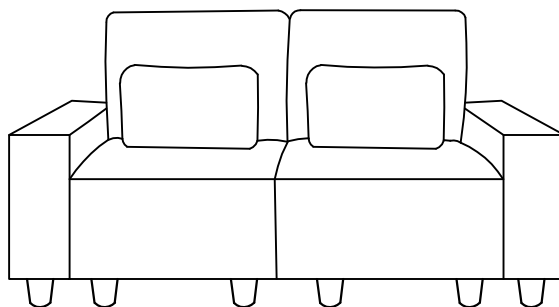
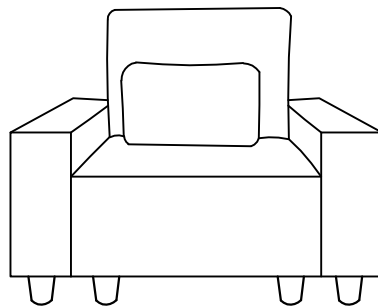

IF YOU BUY 1 SEATER SOFA
Please follow below assembly instruction

Parts List (BOX 1)x1

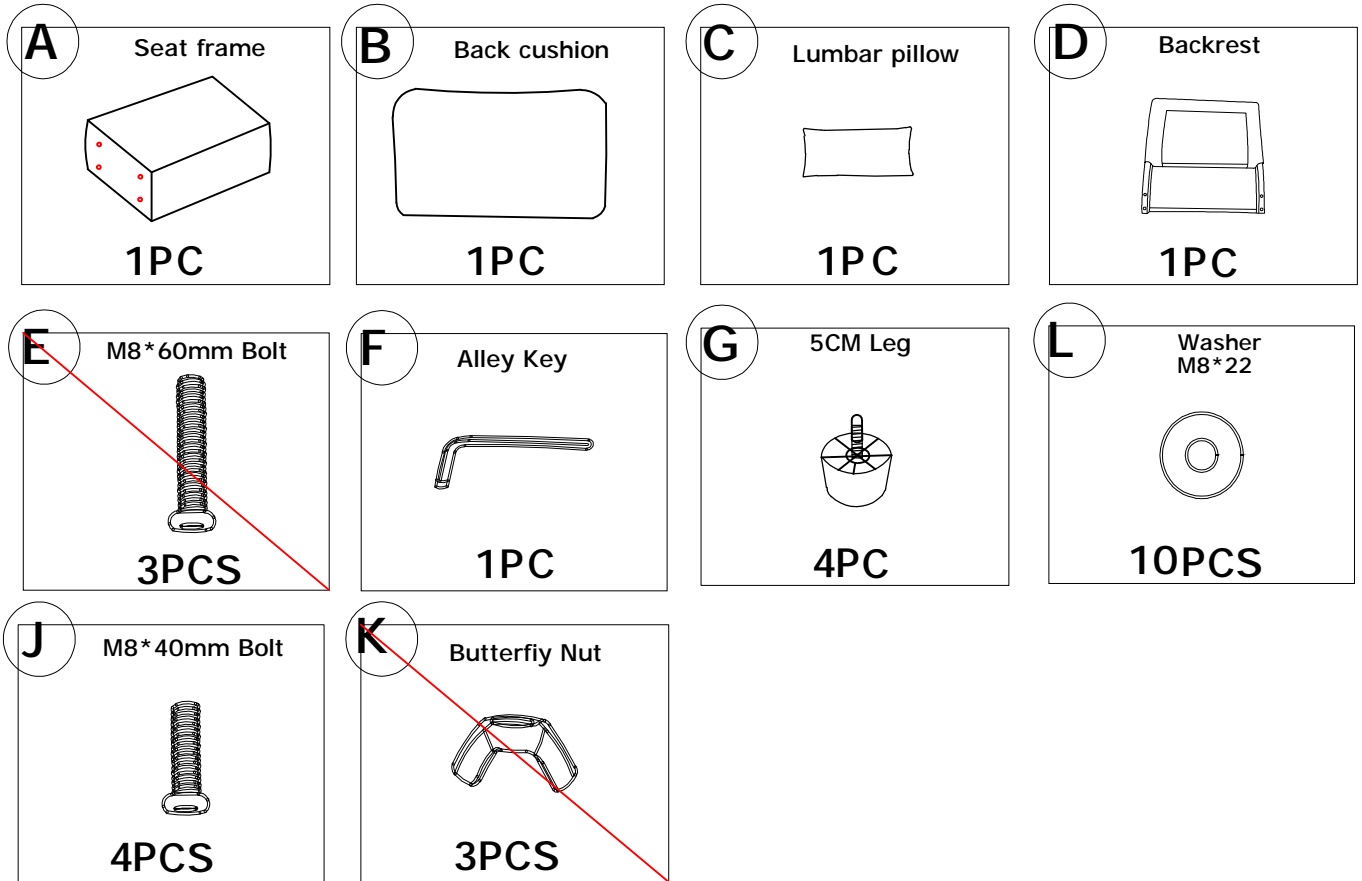

Single sofa do not need to use part E and K

Parts List (BOX 2)x1

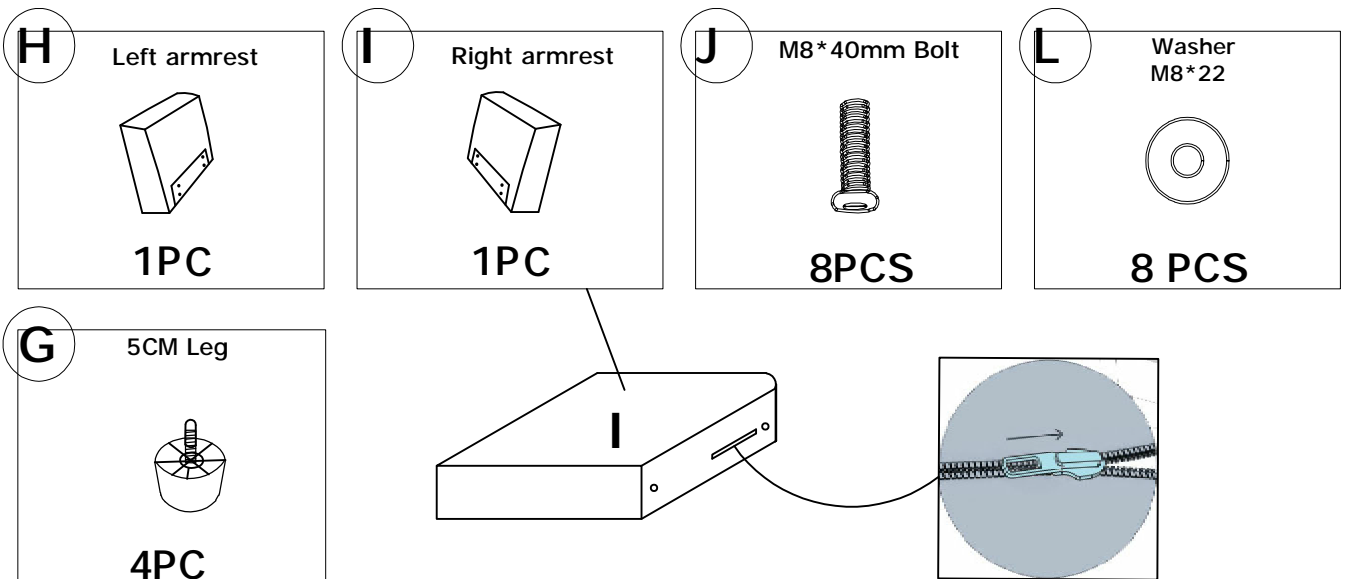

Unzip the compartment underneath the Right armrest and pull out the sofa legs.

STEP 1: Insert the Backrest (D) into the designated holes, using Washer (L) and Bolts (J) to 70% tightness, and then tighten the all Bolts on the seat.

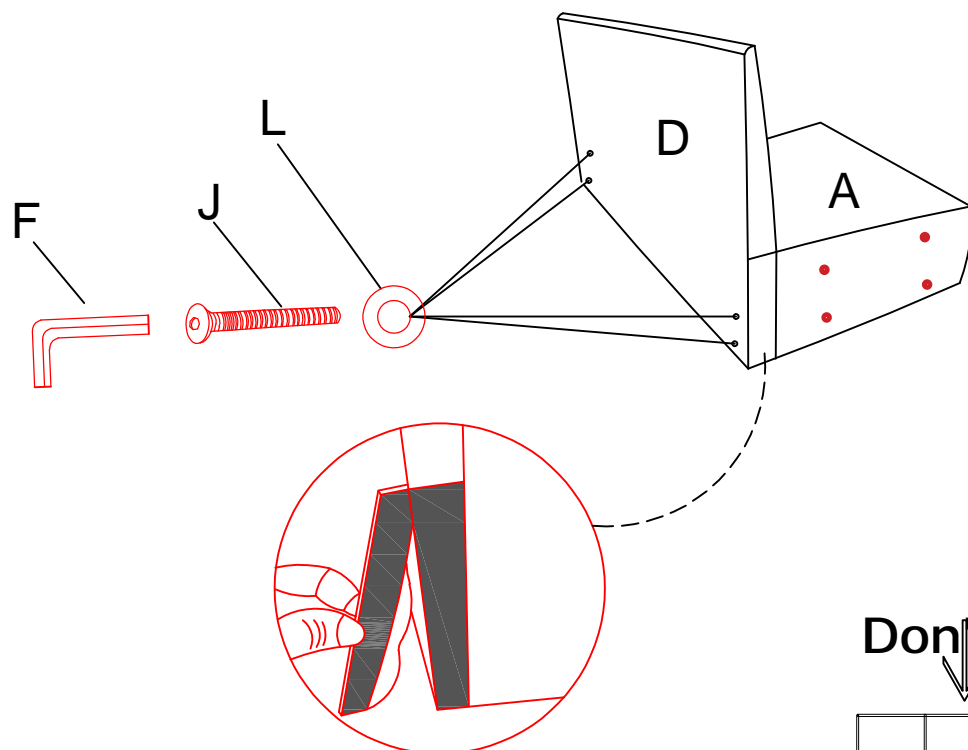

After locking the screws, the backing cloth needs to be attached to the Velcro.

Don't use!

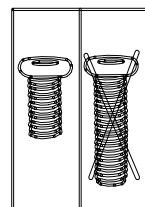

L x 4	
J x 4	

STEP 2: Assemble the Left armrest (H) and the Right armrest (I) to the Seat frame (A) with Washers (L) and Bolts (J).

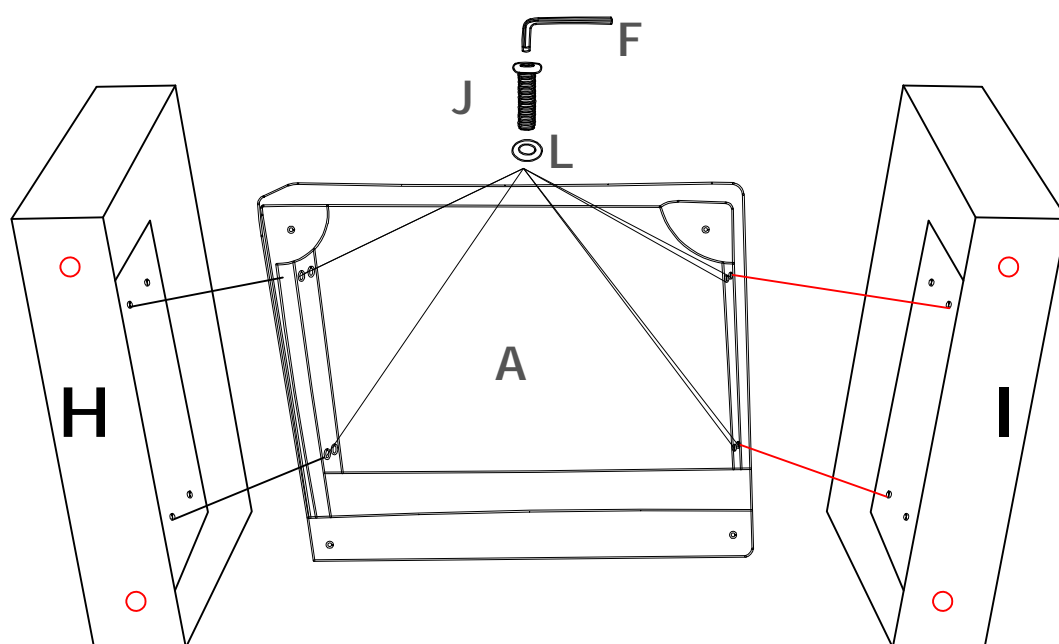

Don't use!

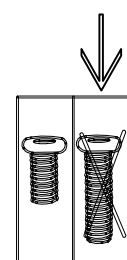

L x 8	
J x 8	

STEP 3: Assemble the Legs (G) on the sofa.

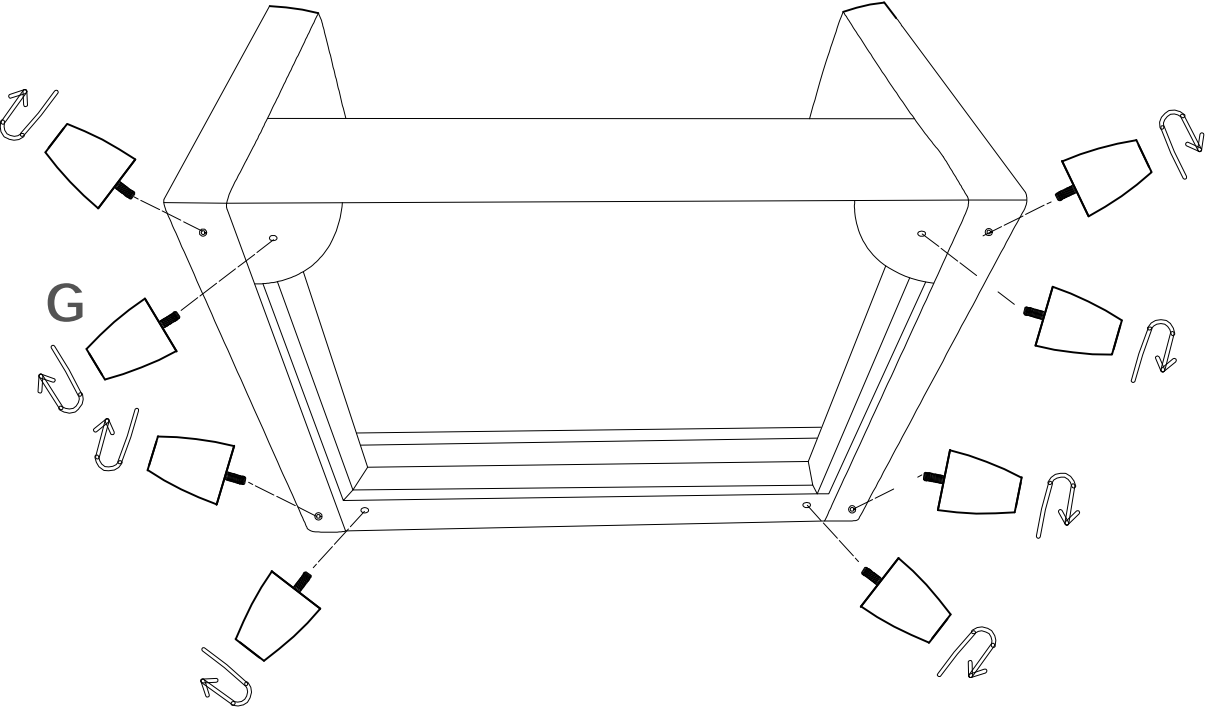

STEP 4: Place Pillows (C) on sofa and make sure it's will fitted.

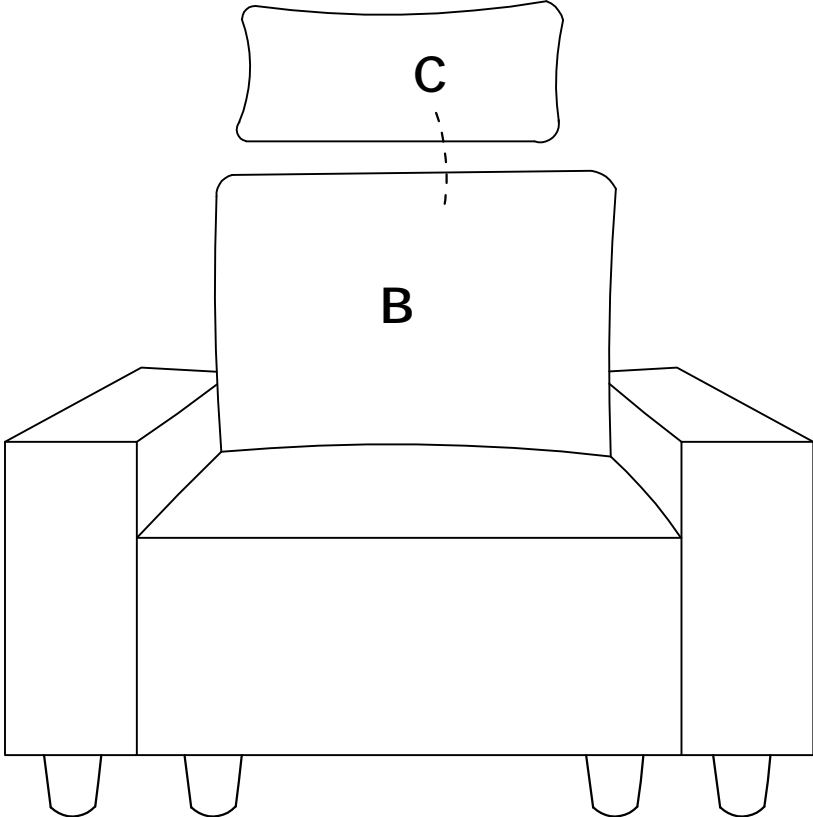

IF YOU BUY 2 SEATER SOFA
Please follow below assembly instruction

Parts List (BOX 1)x2

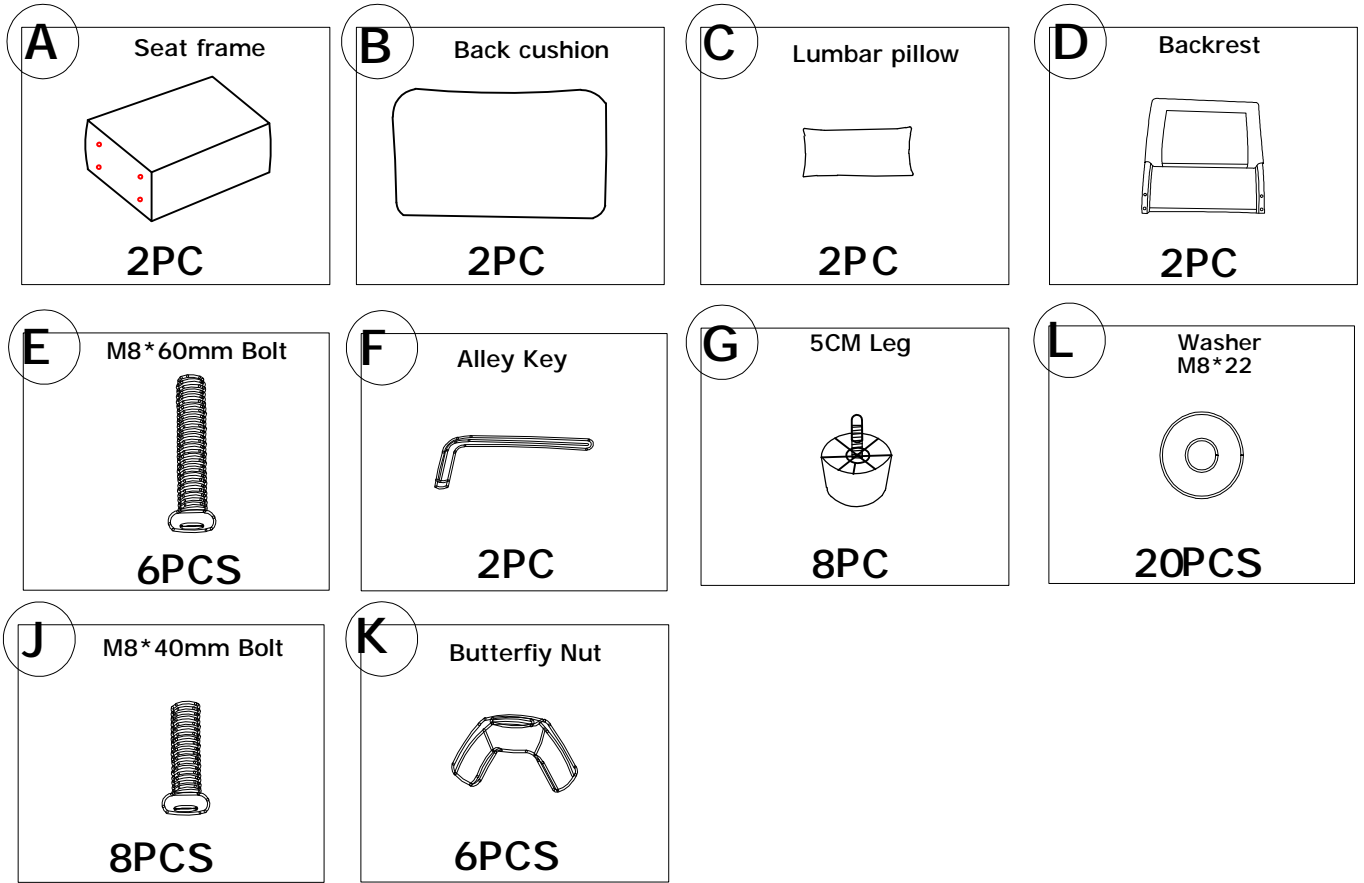

Parts List (BOX 2)x1

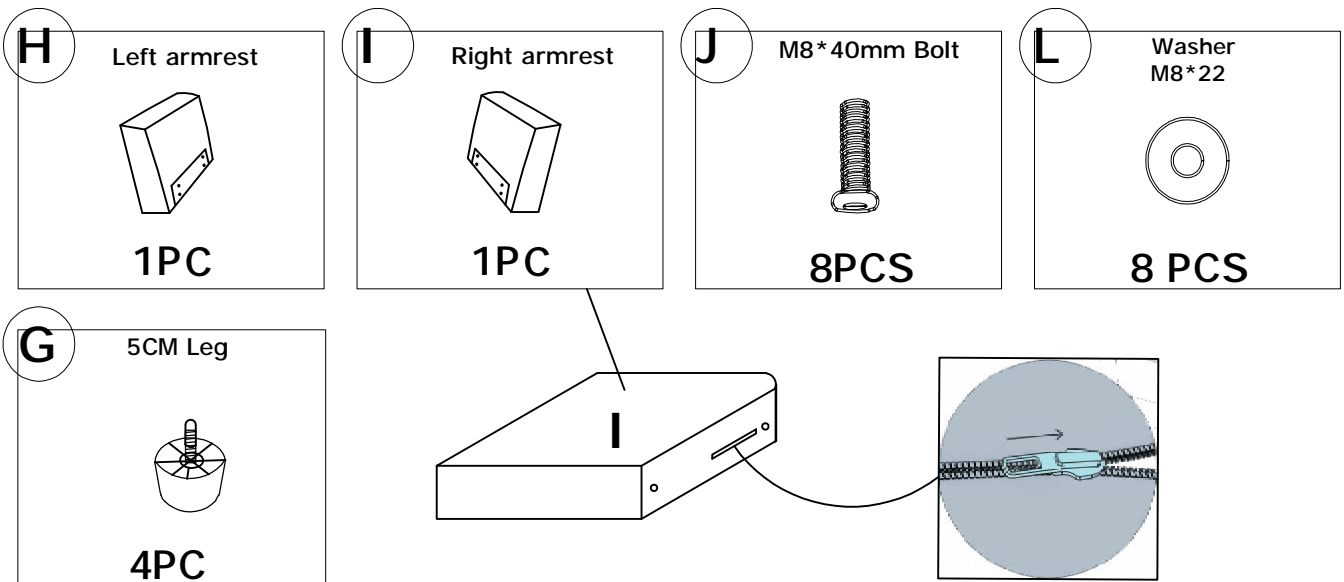

Unzip the compartment underneath the Right armrest and pull out the sofa legs.

STEP 1: Insert the Backrest (D) into the designated holes, using Washer (L) and Bolts (J) to 70% tightness, and then tighten the all Bolts on the seat.

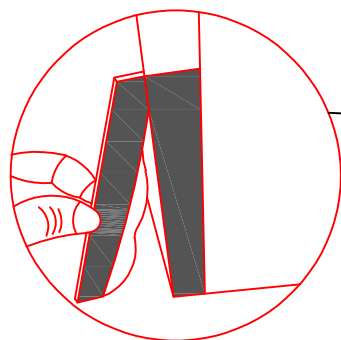
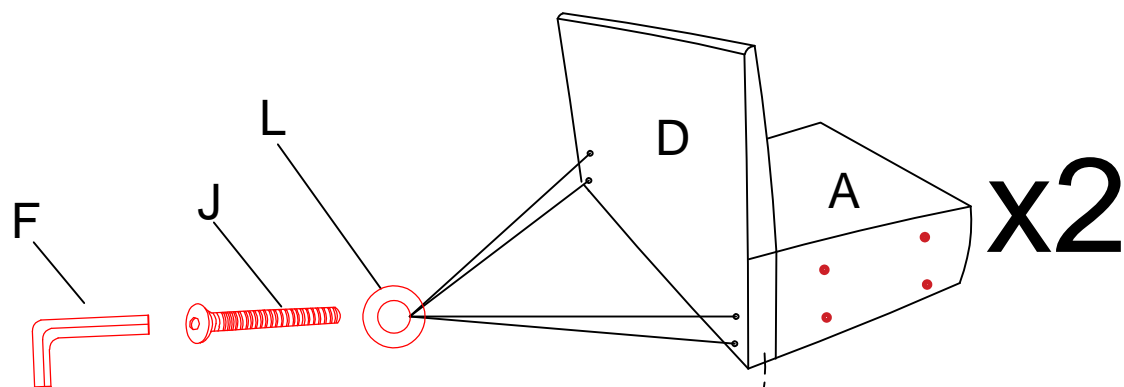

After locking the screws, the backing cloth needs to be attached to the Velcro.

Don't use!

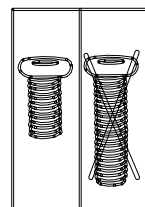

L x 8	
J x 8	

STEP 2: Assemble the Left armrest (H) and the Right armrest (I) to the Seat frame (A) with Washers (L) and Bolts (J).

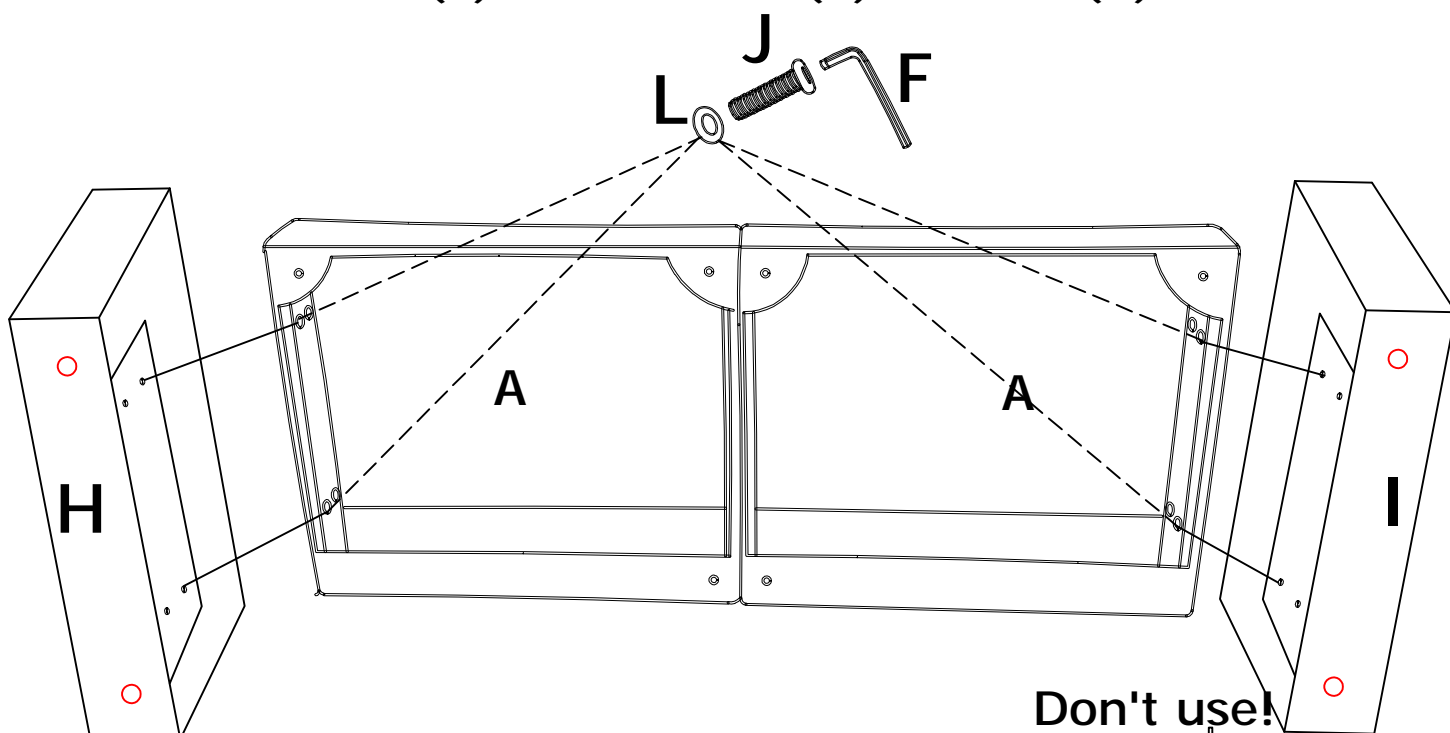

Don't use!

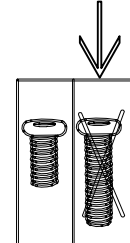

L x 8	
J x 8	

STEP 3: Assemble Seat frame (A) and Seat frame (A) with Butterfly nuts (K) Washers (L) and Bolts (E).

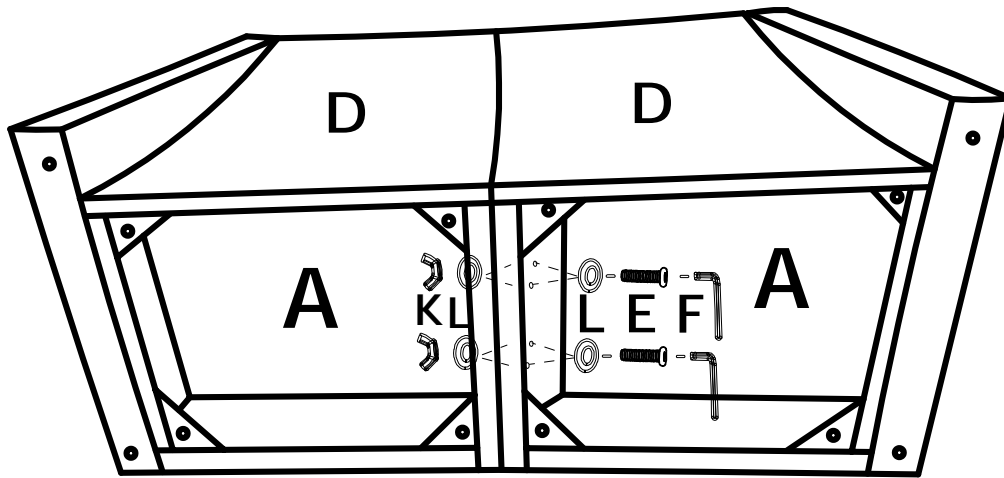

Don't use!

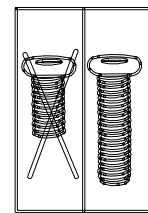

L x 8	
E x 4	
K x 4	

STEP 4: Assemble the Legs (G) on the sofa.

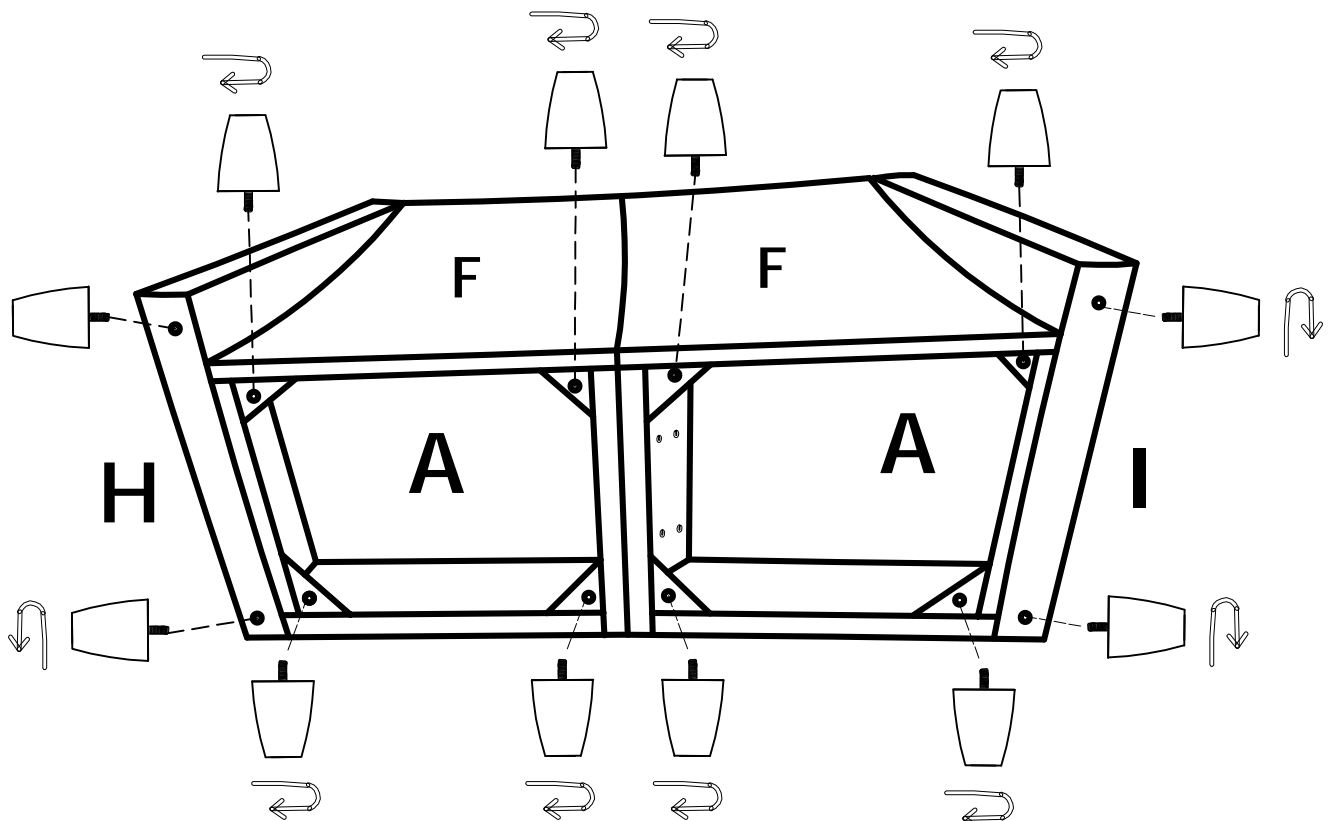

STEP 5: Place back cushions (B) on sofa, and make sure it's will fitted.

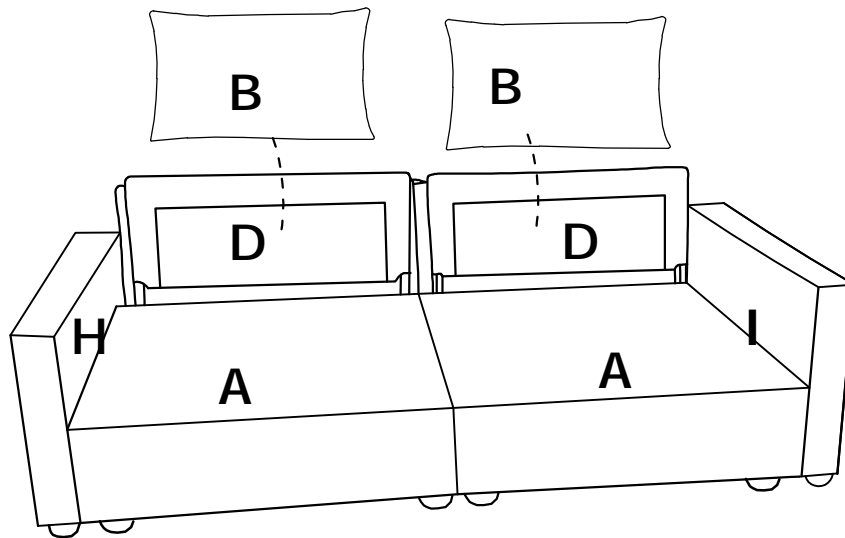

STEP 6: Place the Pillow (C) on sofa, and make sure it's will fitted.

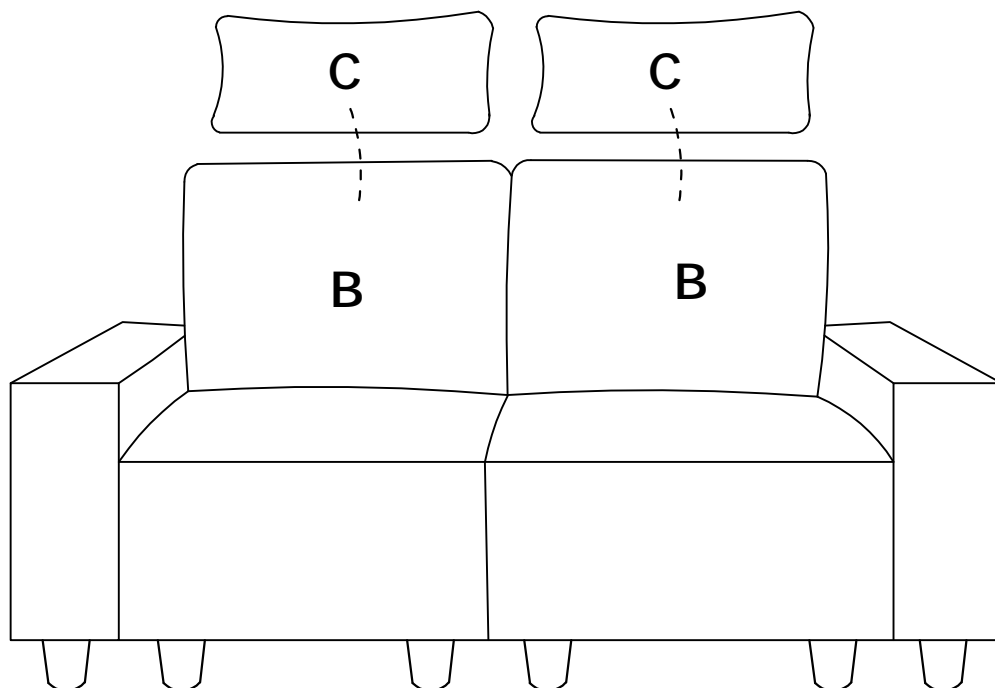

IF YOU BUY 3 SEATER SOFA
Please follow below assembly instruction

Parts List (BOX 1)x3

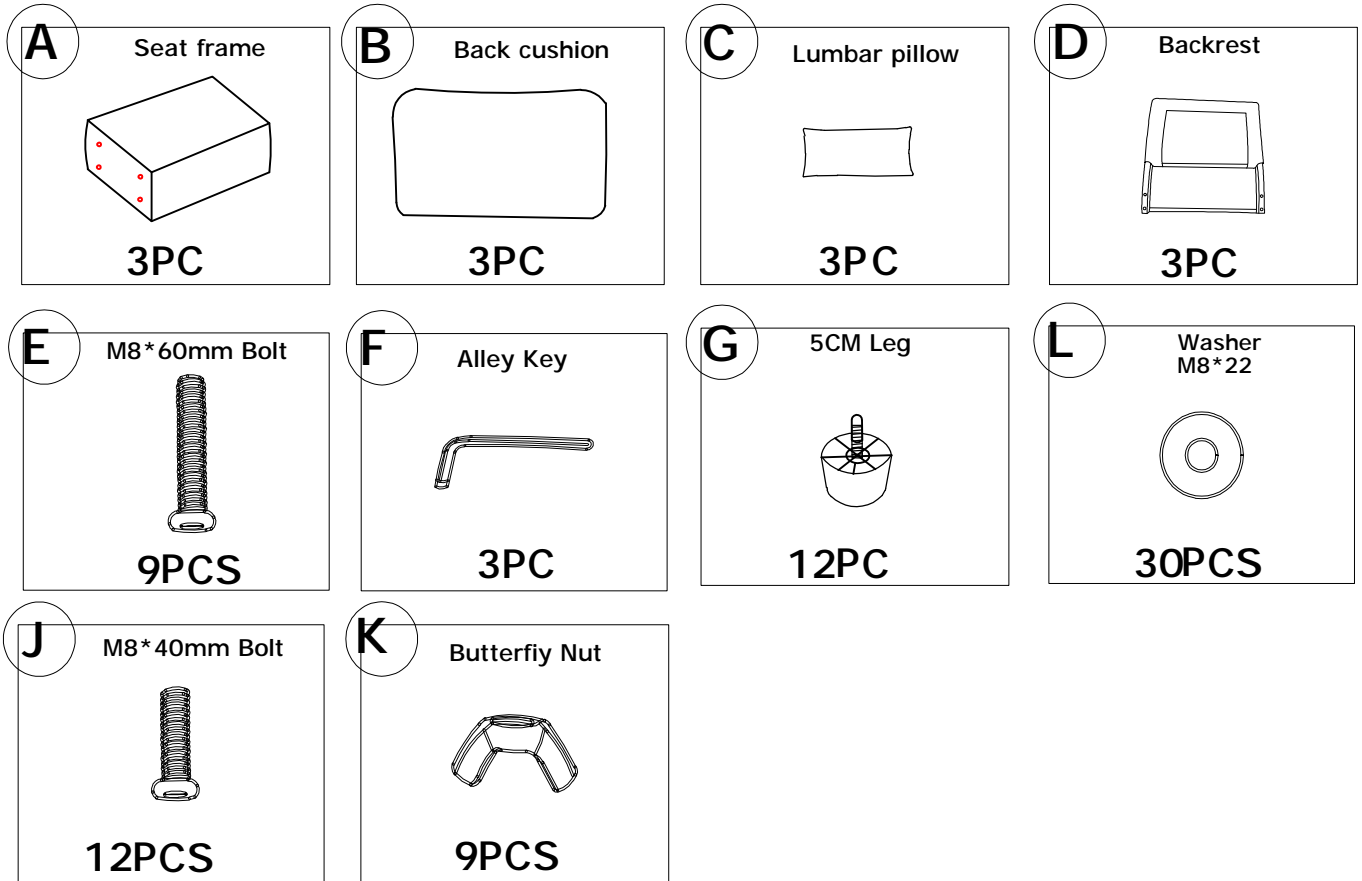

Parts List (BOX 2)x1

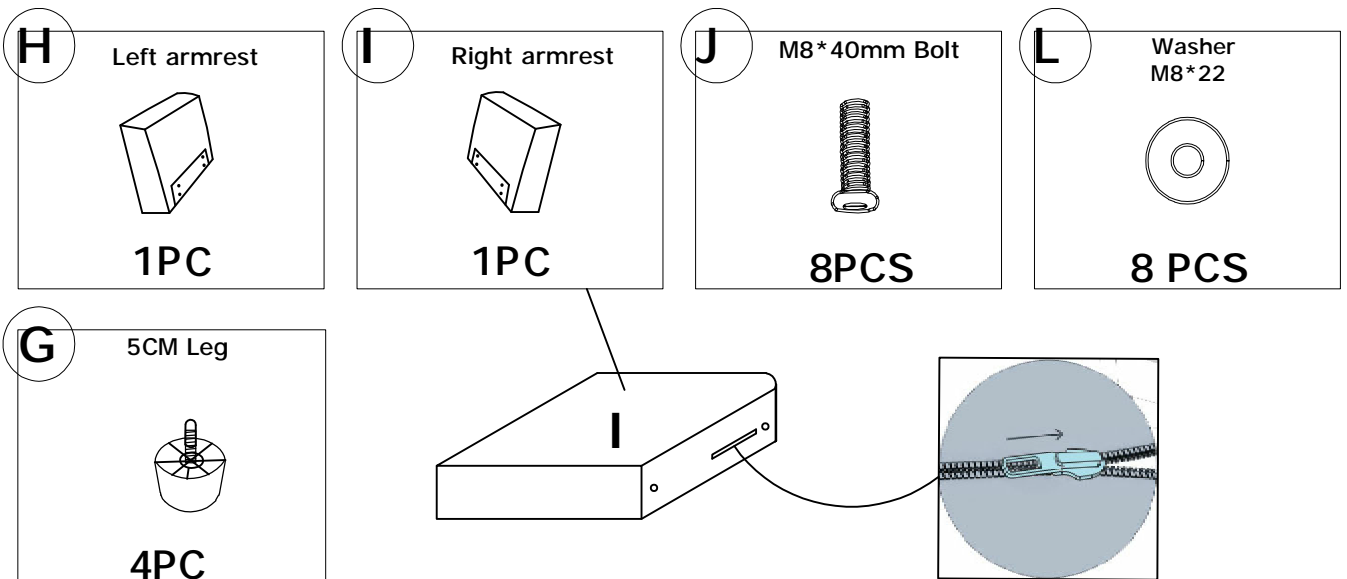

Unzip the compartment underneath the Right armrest and pull out the sofa legs.



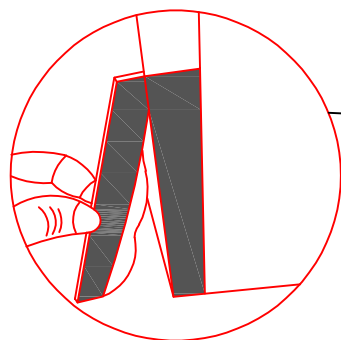
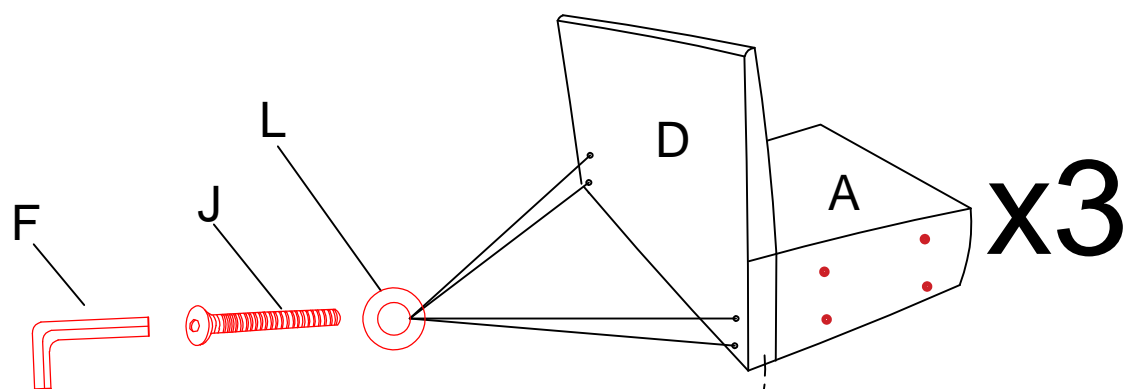

STEP 1: Insert the Backrest (D) into the designated holes, using Washer (L) and Bolts (J) to 70% tightness, and then tighten the all Bolts on the seat.

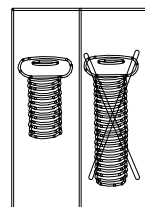

After locking the screws, the backing cloth needs to be attached to the Velcro.

Don't use!





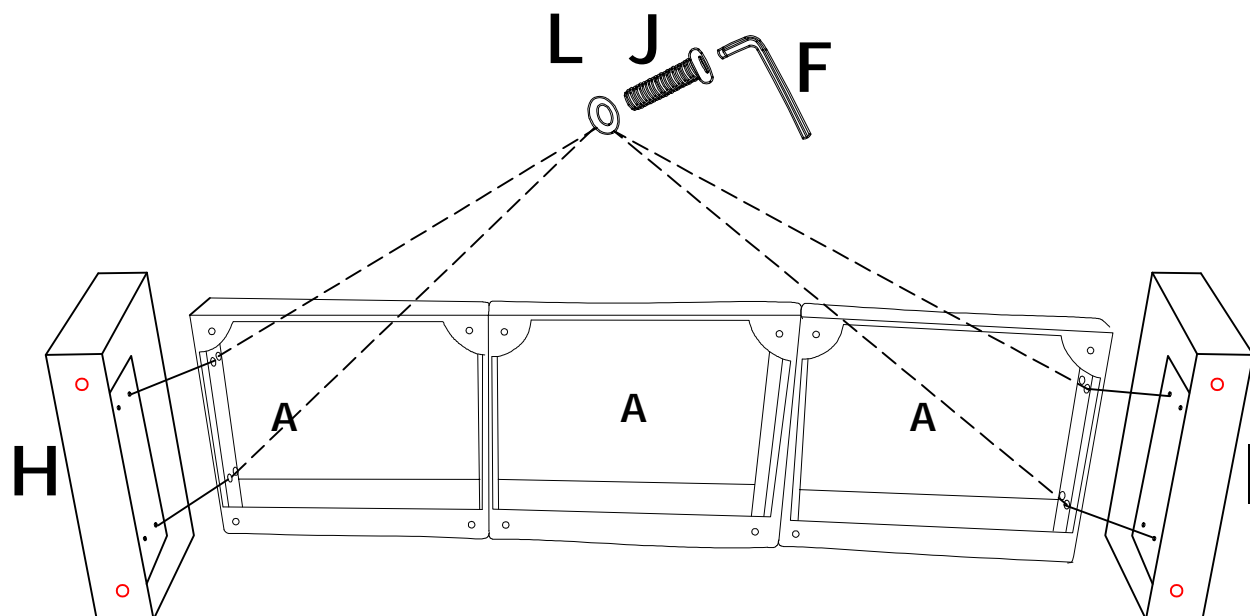

	x12	
	x12	

STEP 2: Assemble the Left armrest (H) and the Right armrest (I) to the Seat frame (A) with Washers (L) and Bolts (J).

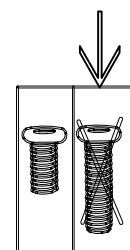

Don't use!



	x8	
	x8	

STEP 5: Place back cushions (B) on sofa, and make sure it's will fitted.

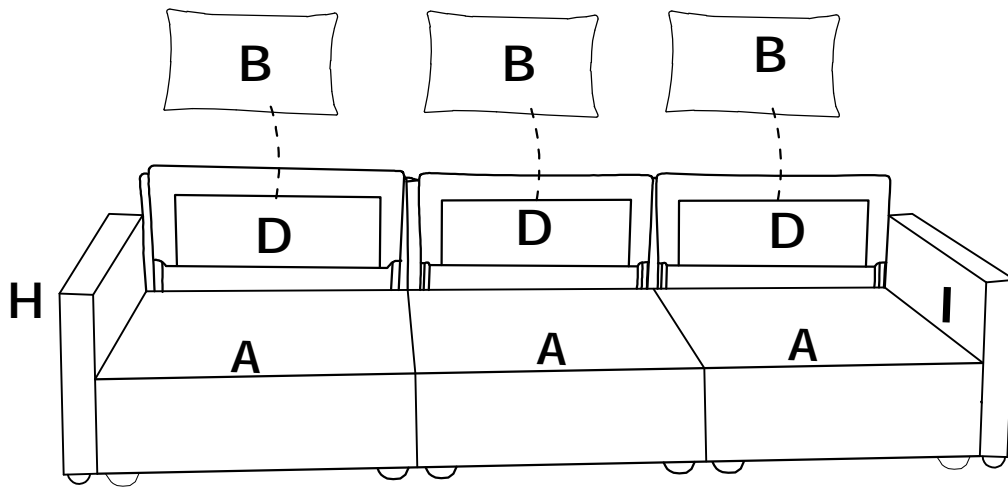

STEP 6: Place the Pillow (C) on sofa, and make sure it's will fitted.

