

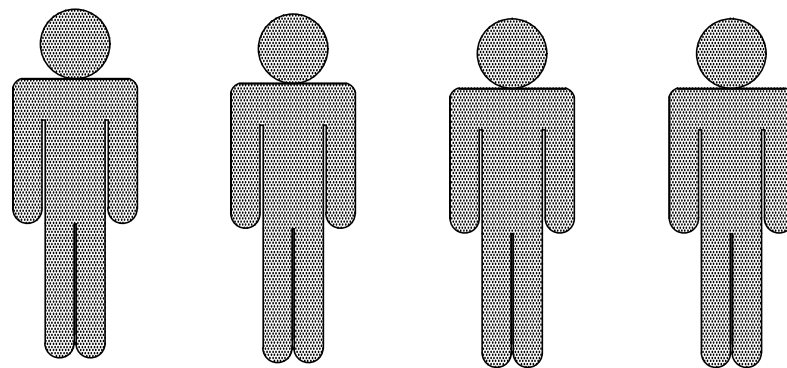

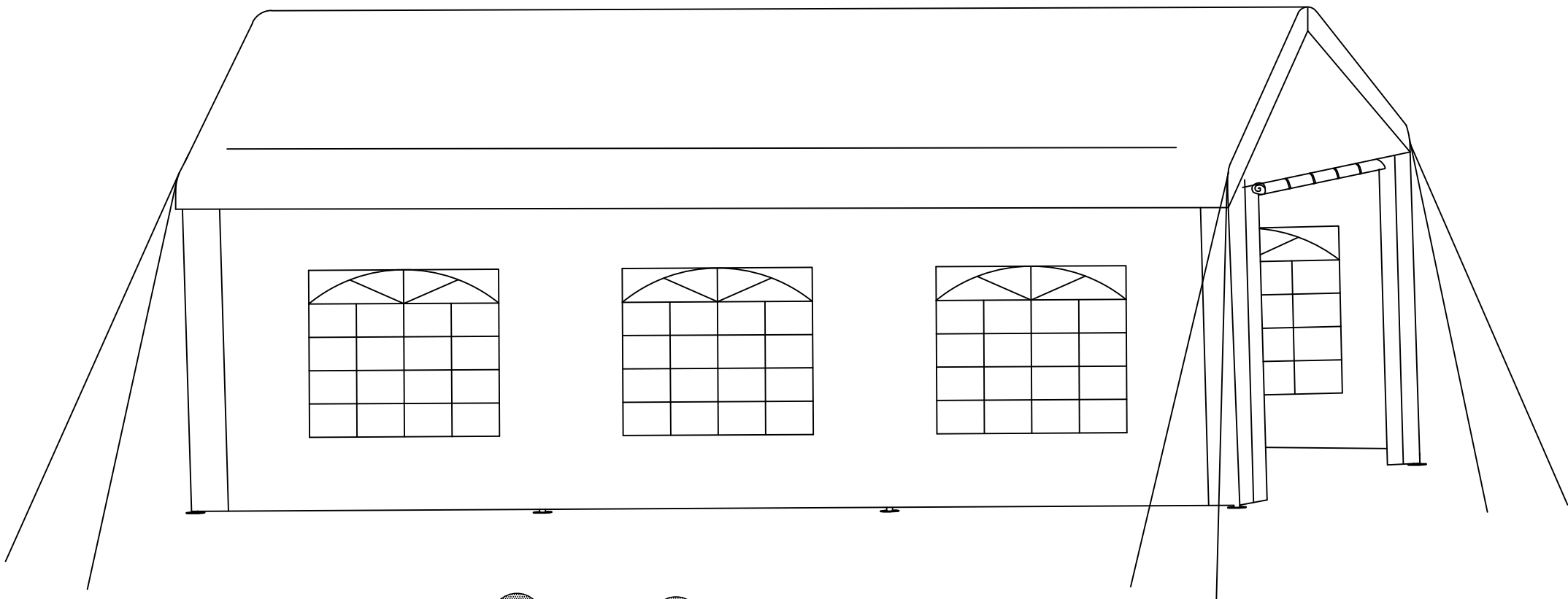

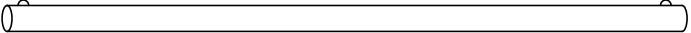

3 X 6 M

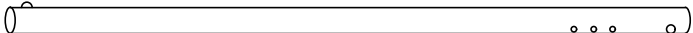
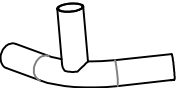
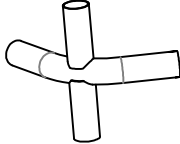
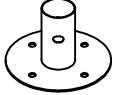

①	 $\phi 38 \times 1930$	X9
②	 $\phi 38 \times 1585$	X8
③	 $\phi 38 \times 1930$	X8
A		X6
B		X6
C		X8
D	 M6*50mm	X8

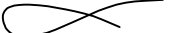
1

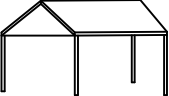
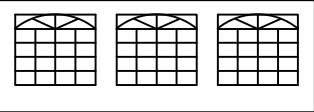
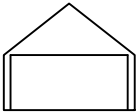
Ⓔ		X70
Ⓕ		X8
Ⓖ	 $\phi 5$	X24
Ⓕ		X1
Ⓖ		X2
Ⓖ		X2

2

1



① 9pcs



A 6pcs



B 6pcs



2

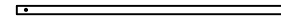

② 8pcs

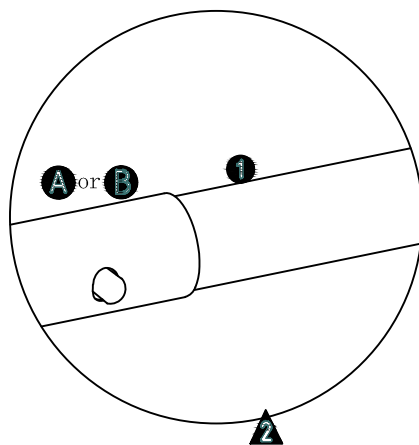
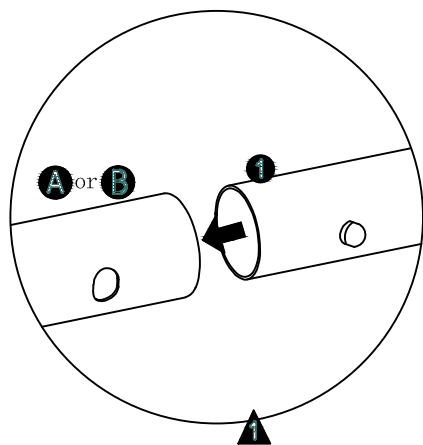
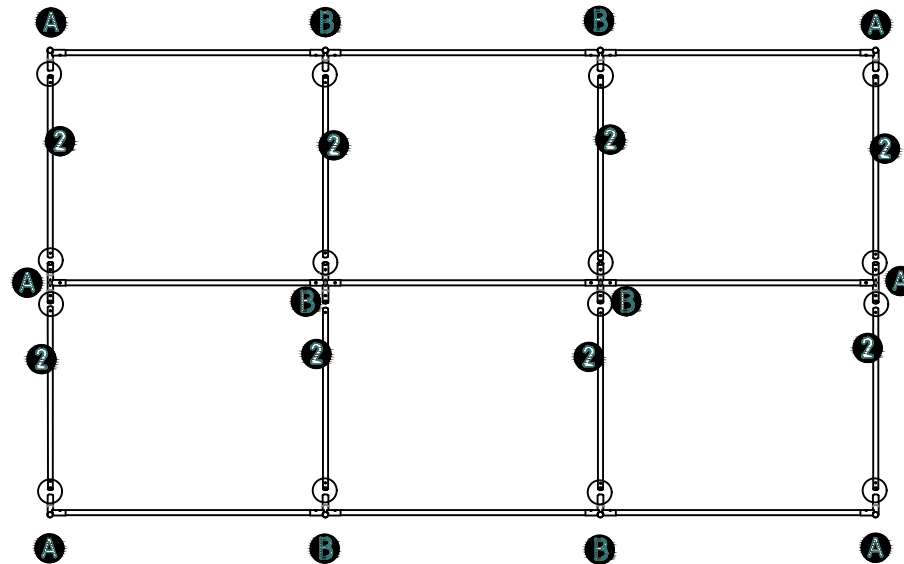

3

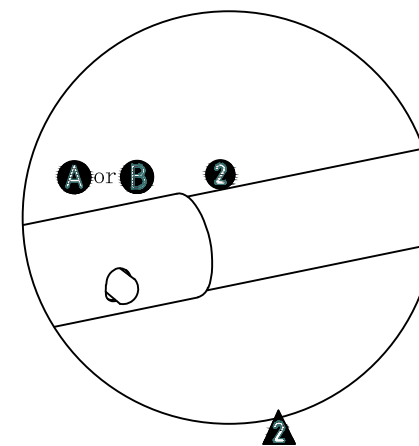
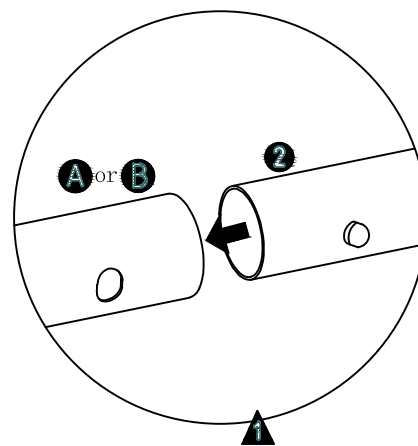

4

3

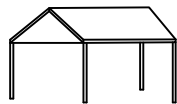

H 1pc



E 46pcs

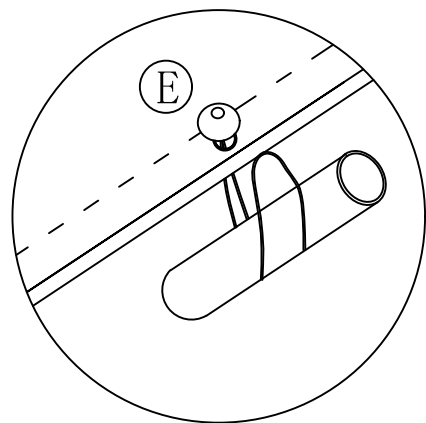
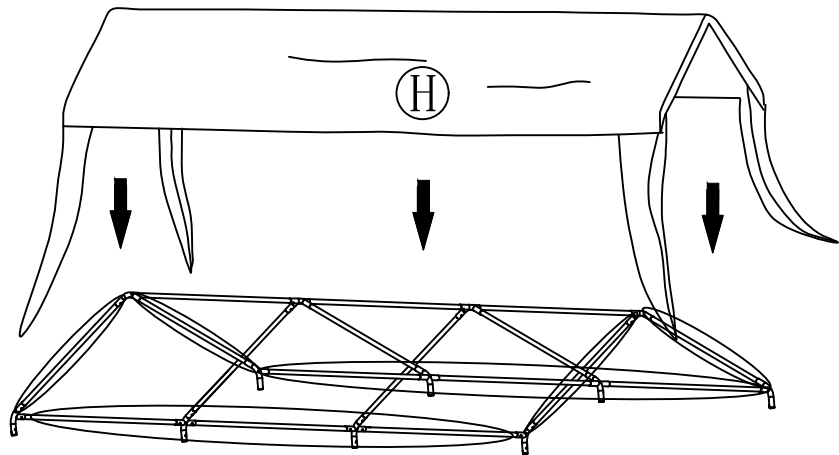

5

4

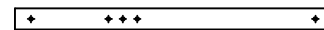

3 4pcs

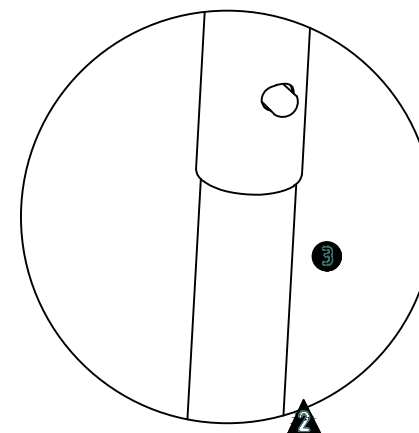
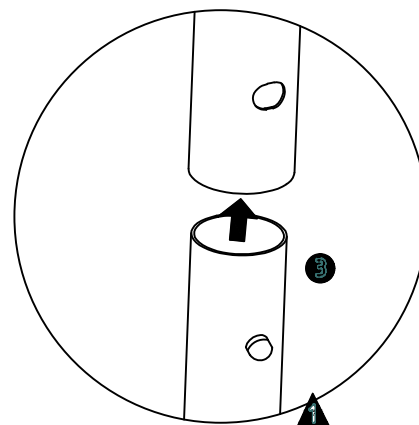
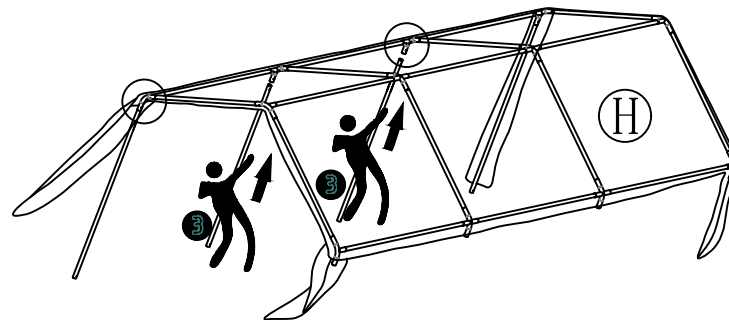
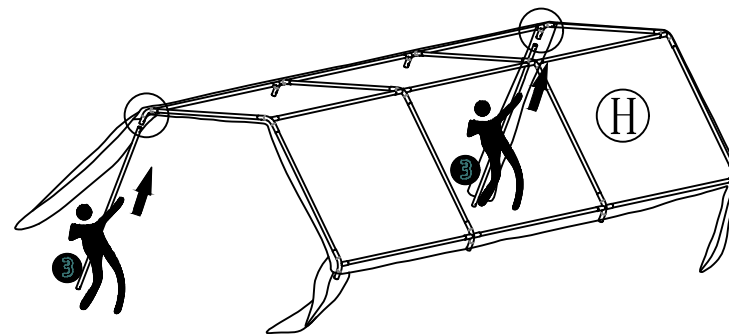

6

5

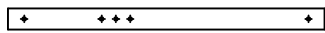

③ 4pcs

6



Ⓒ 8pcs



Ⓓ 8pcs

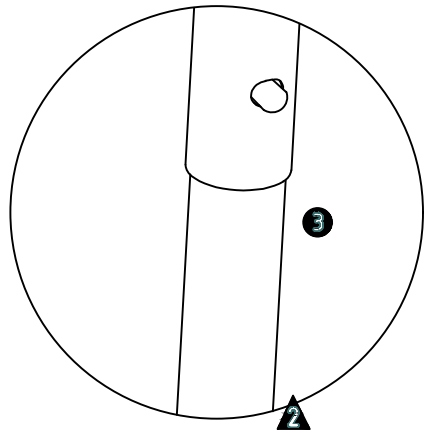
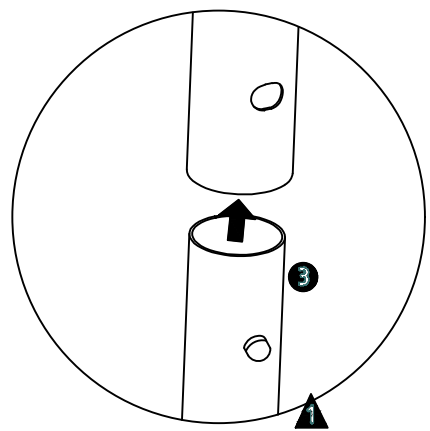
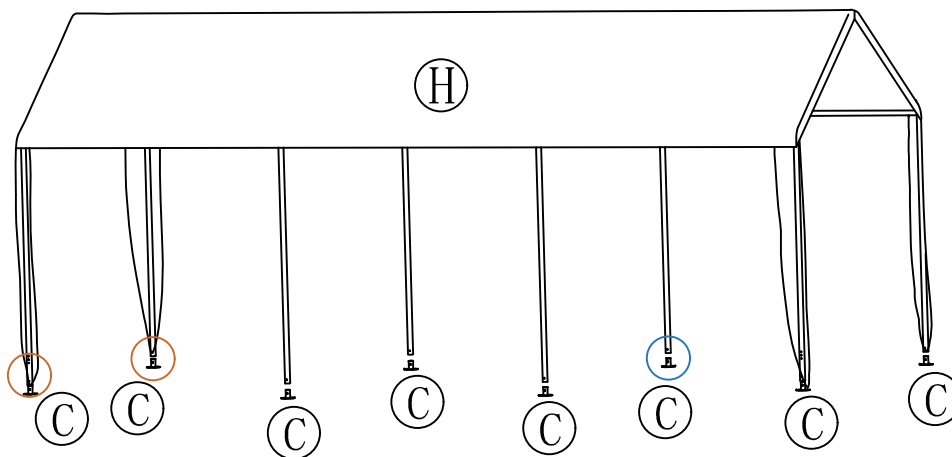
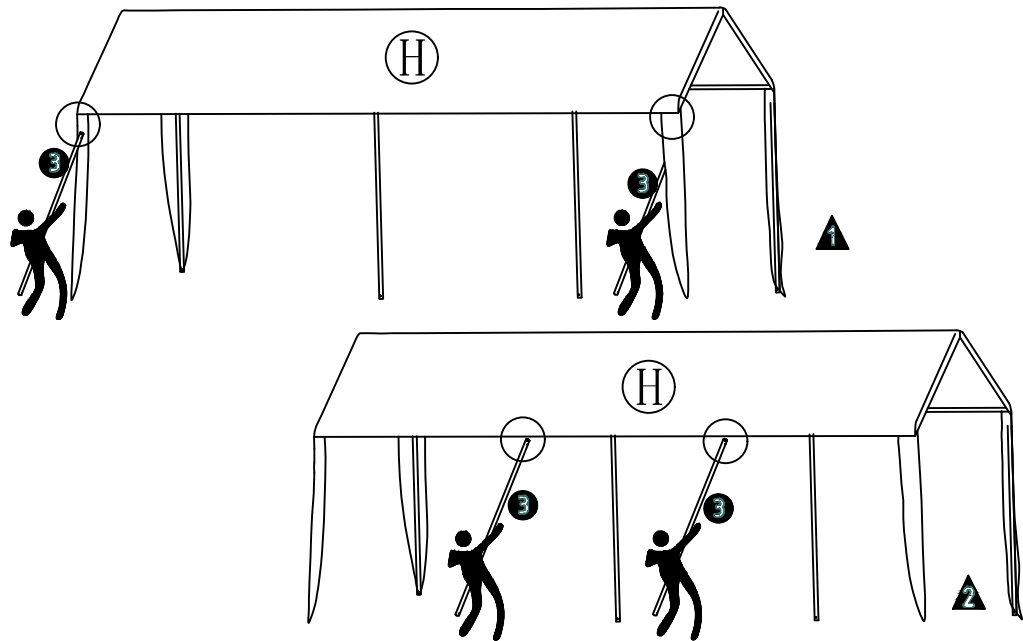

7

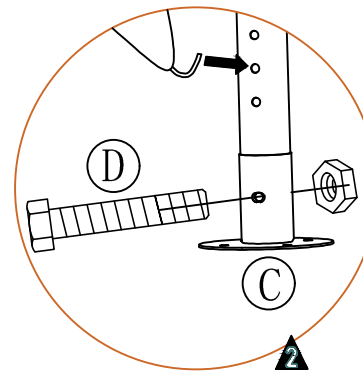
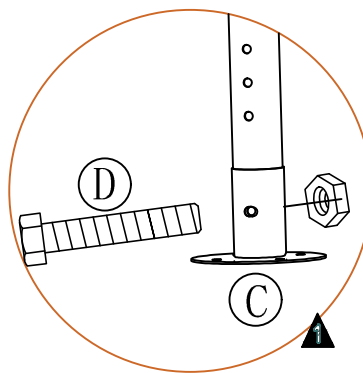

8

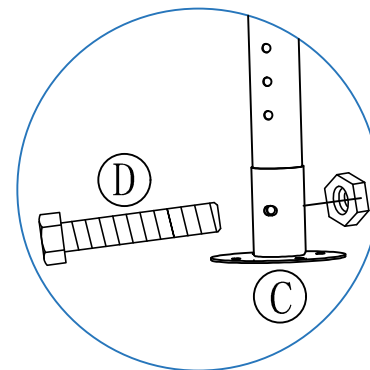

7

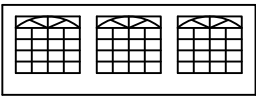
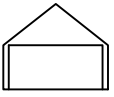

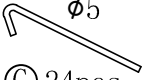
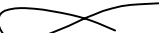

(E) 16pcs (I) 2pcs (J) 2pcs

8

(G) 24pcs (F) 8pcs

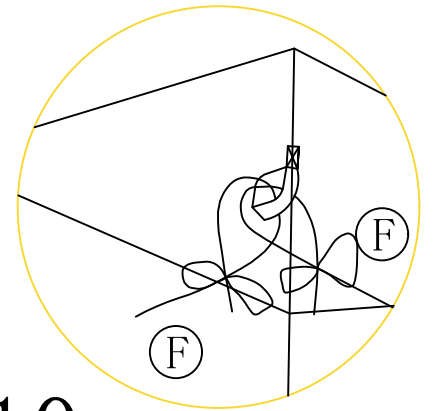
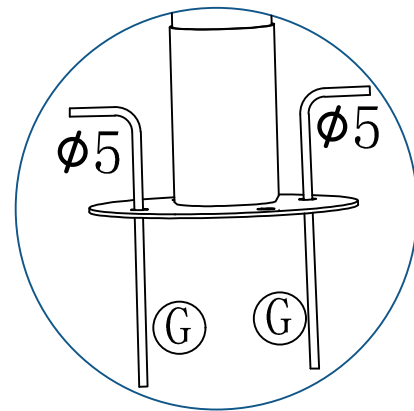
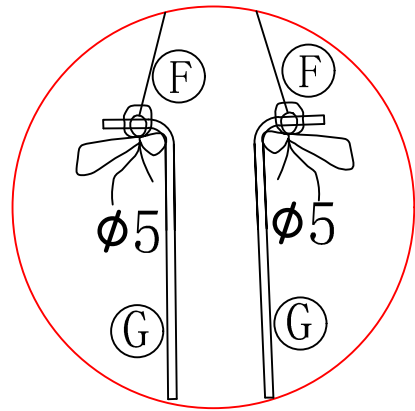
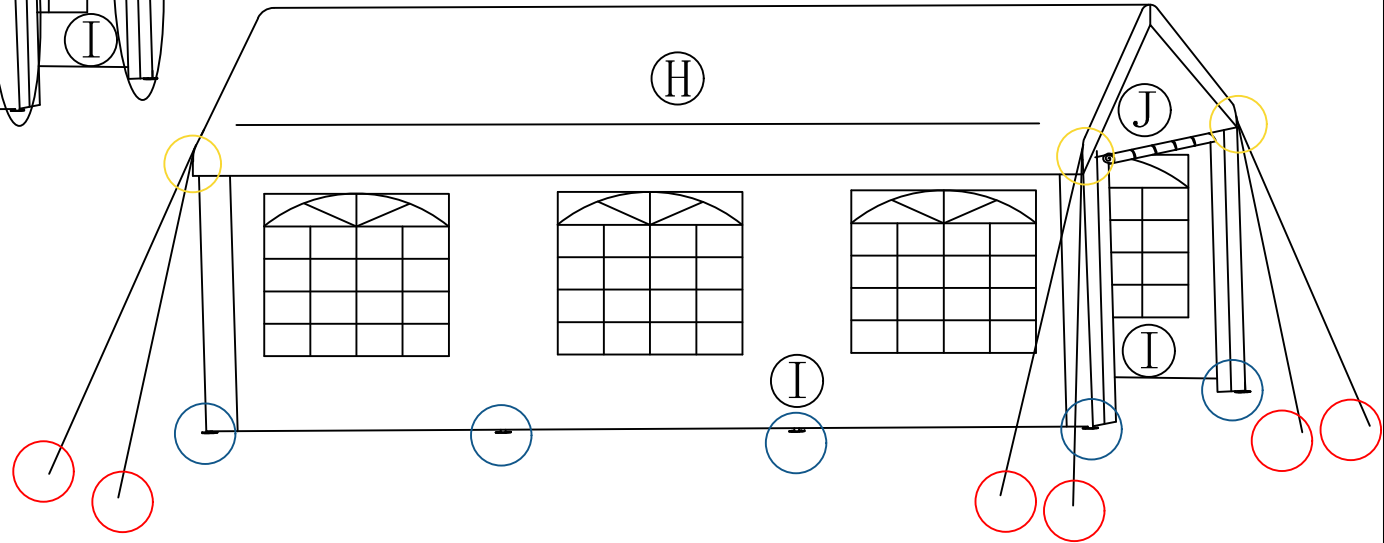
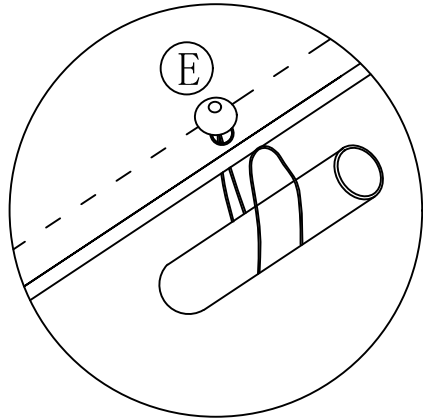
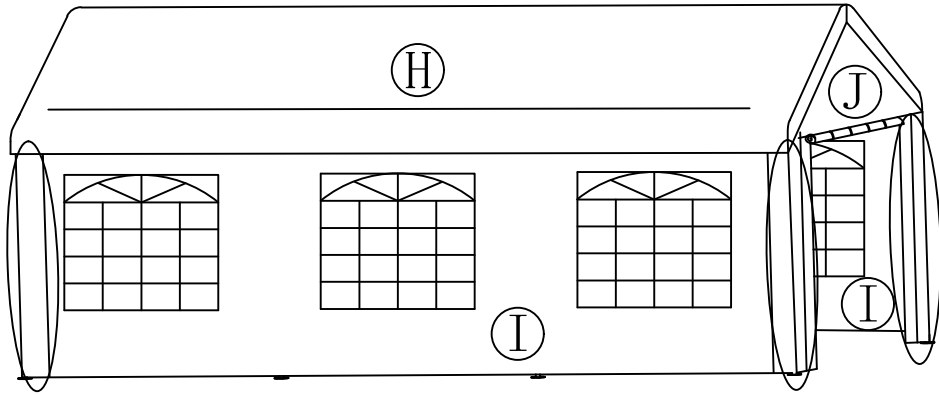

9

10

9

10

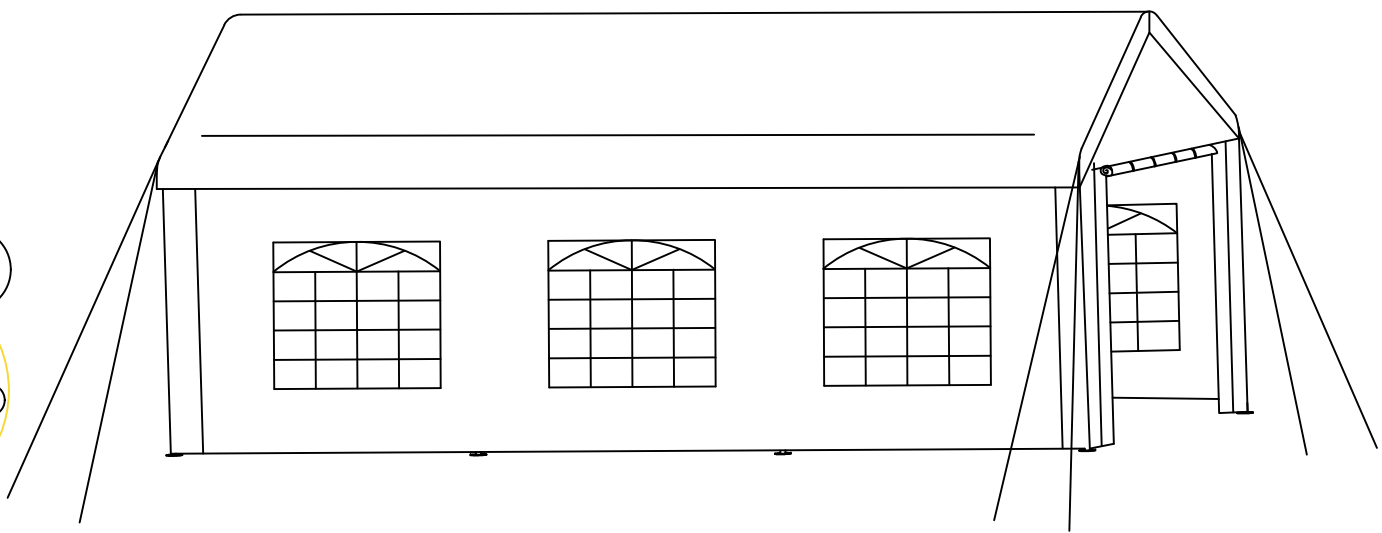
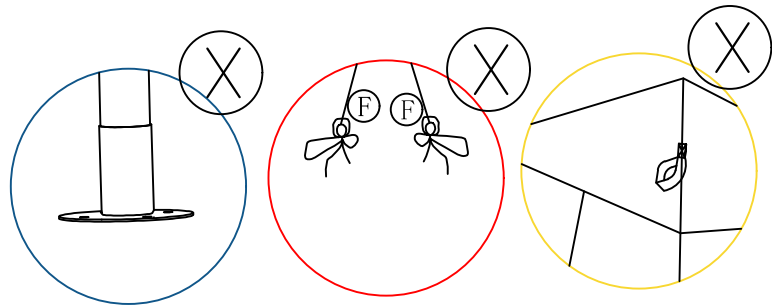
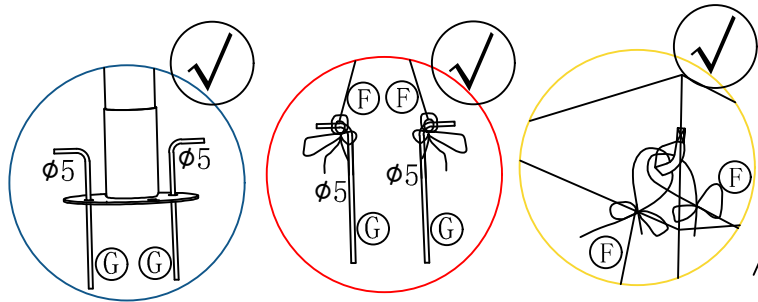

11

12