

Features

- UltraGlide® valves with dry-stem technology are designed to eliminate common leak paths and provide smooth, effortless control
- Two Lever handles offer separate control of hot and cold water
- Coordinates with other products in the Purist collection
- 1.5 gpm (5.7 lpm) maximum flow rate at 60 psi (4.14 bar)

Material

- Premium metal construction for durability and reliability
- KOHLER finishes resist corrosion and tarnishing

Installation

- Wall-mount



ADA

CSA B651

Codes/Standards











ASME A112.18.1/CSA B125.1
NSF/ANSI/CAN 61
NSF/ANSI/CAN 372
DOE - Energy Policy Act 1992
California Energy Commission (CEC)
ADA
ICC/ANSI A117.1
CSA B651

KOHLER® Faucet Lifetime Limited Warranty

See website for detailed warranty information.

Available Colors/Finishes

Color tiles intended for reference only.

Color	Code	Description
	CP	Polished Chrome
	SN	Vibrant® Polished Nickel
	AF	Vibrant® French Gold
	VS	Vibrant® Stainless
	BV	Vibrant® Brushed Bronze
	BL	Matte Black
	2MB	Vibrant® Brushed Moderne Brass
	BGP	Brushed Graphite
	TT	Vibrant Titanium
	DR	Deep Bronze

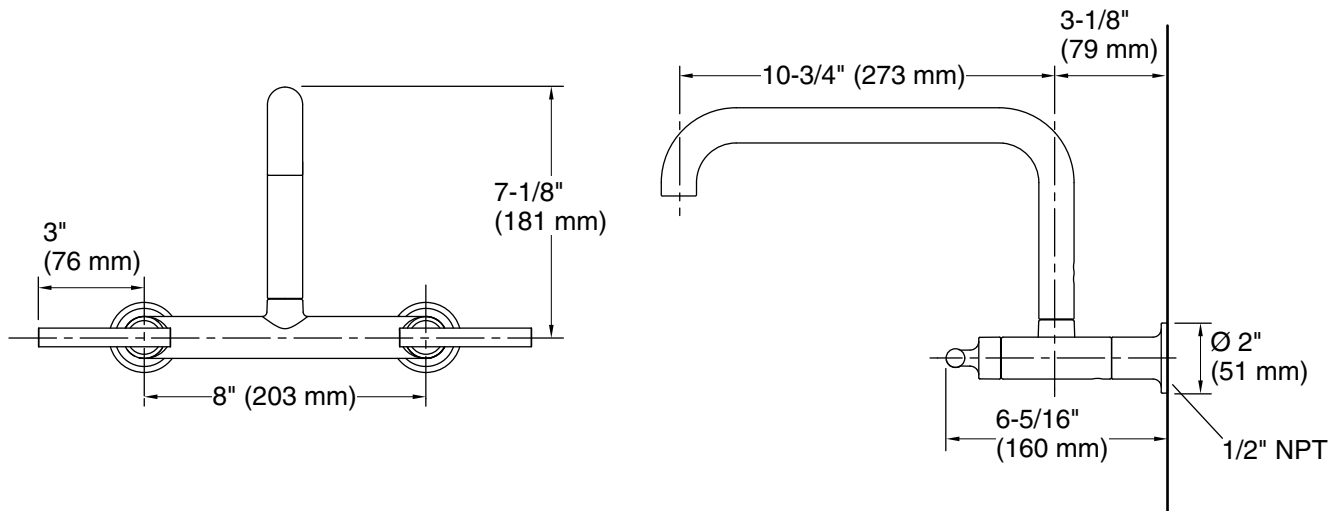

Technical Information

All product dimensions are nominal.

Faucet flow rate: 1.5 gal/min (5.7 l/min)

Spout:

Spout reach: 10-3/4" (272 mm)

Notes

Install this product according to the installation instructions.

ADA compliant for faucet handles only

ADA, CSA B651 compliant when installed to the specific requirements of these regulations.