



Tempered Glass Mobile Laptop Desk Cart



Model: OFF65934B/5B







Please contact Seville Classics for help with assembly and to report any damaged or missing components.



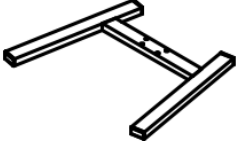
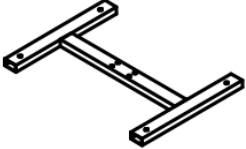
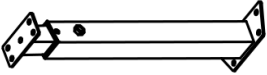
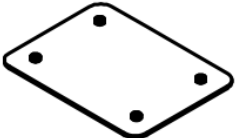



Phone: 1 (800) 323-5565

Email: Support@SevilleClassics.com

Homepage: www.SevilleClassics.com

Parts List

A. Base (1)	
B. Top frame (1)	
C. Neck frame (1)	
D. Top (1)	
E Casters (2)	
F. Locking casters (2)	
G. Large wrench (1)	
H. Knob (1)	
I. Caps (4)	

J. Nut (8)	
K. Washer (8)	
L. Short bolt (4)	
M. Medium bolt (4)	
N. Long bolt (4)	
O. Small wrench (1)	
P. Hex key (1)	

Please make sure you have all the parts on this list.

If you're missing parts, contact us for replacements at
(800) 323-5565 or send an email to Support@SevilleClassics.com

Assembly Instructions

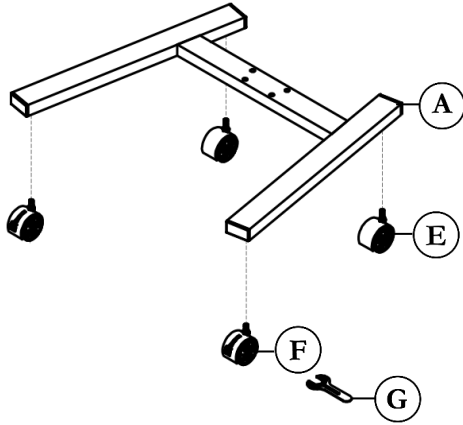

STEP 1.

Attach **LOCKING CASTERS (F)** to wide side of **BASE (A)**, and **CASTERS (E)** to narrow side of **BASE (A)** with **LARGE WRENCH (G)**.

STEP 2.

Press **CAPS (I)** into ends of **TOP FRAME (B)**.

Fit **MEDIUM BOLTS (M)** through top of **TOP FRAME (B)** into the top of **NECK (C)**. Fit **WASHERS (K)** over threads and attach with **NUTS (J)**.

Hold bolts with **HEX KEY (P)** and tighten with **SMALL WRENCH (O)**.

Screw in **KNOB (H)** to side of frame to lock the height adjustment.

STEP 3.

Align holes on bottom of **NECK (C)** with **BOTTOM FRAME (A)**.

Fit **LARGE BOLTS (N)** through **WASHERS (K)** into base of **NECK (C)** and through **BASE (A)**.

Attach with **NUTS (J)** using **SMALL WRENCH (O)**. Hold bolts steady with **HEX KEY (P)**.

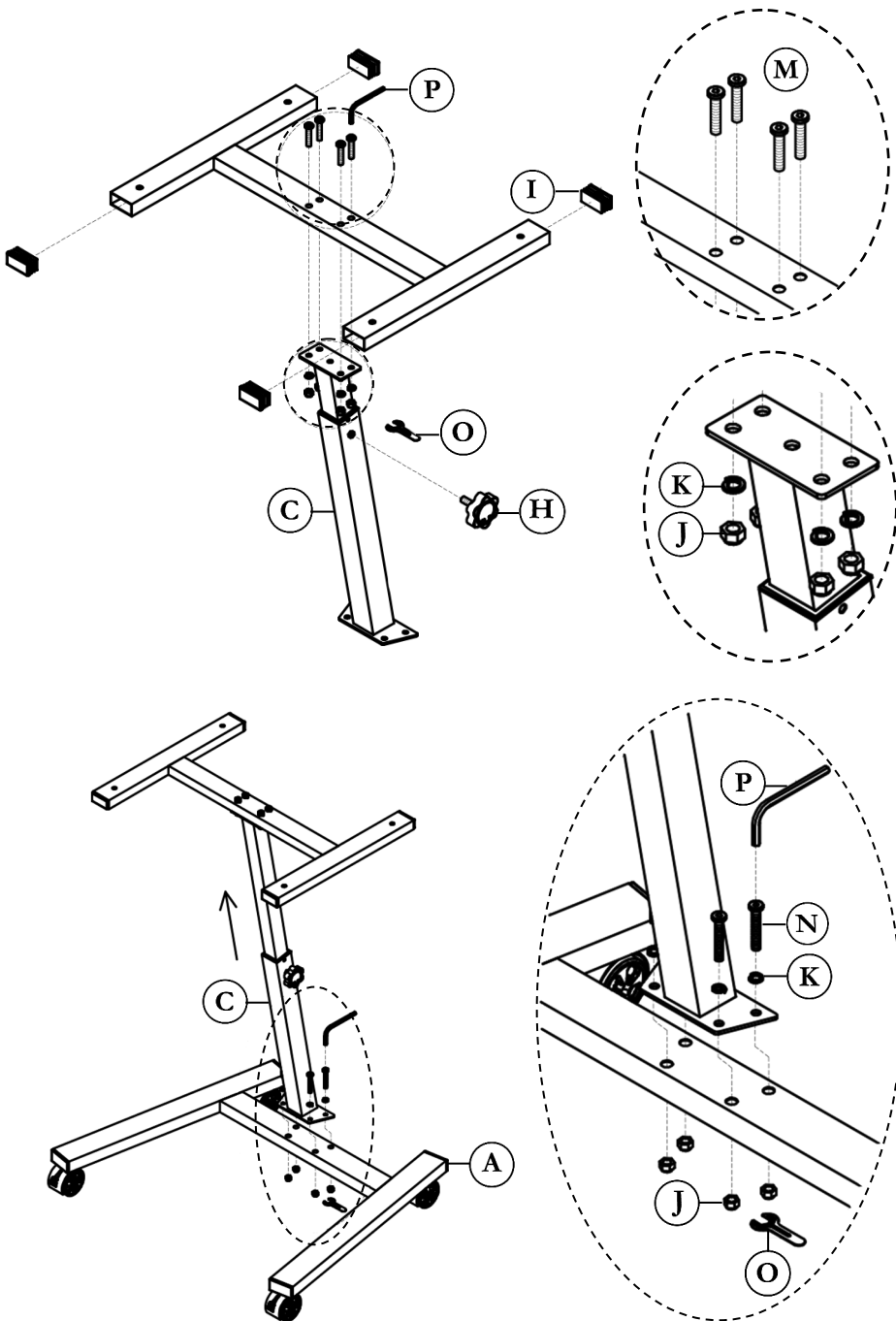

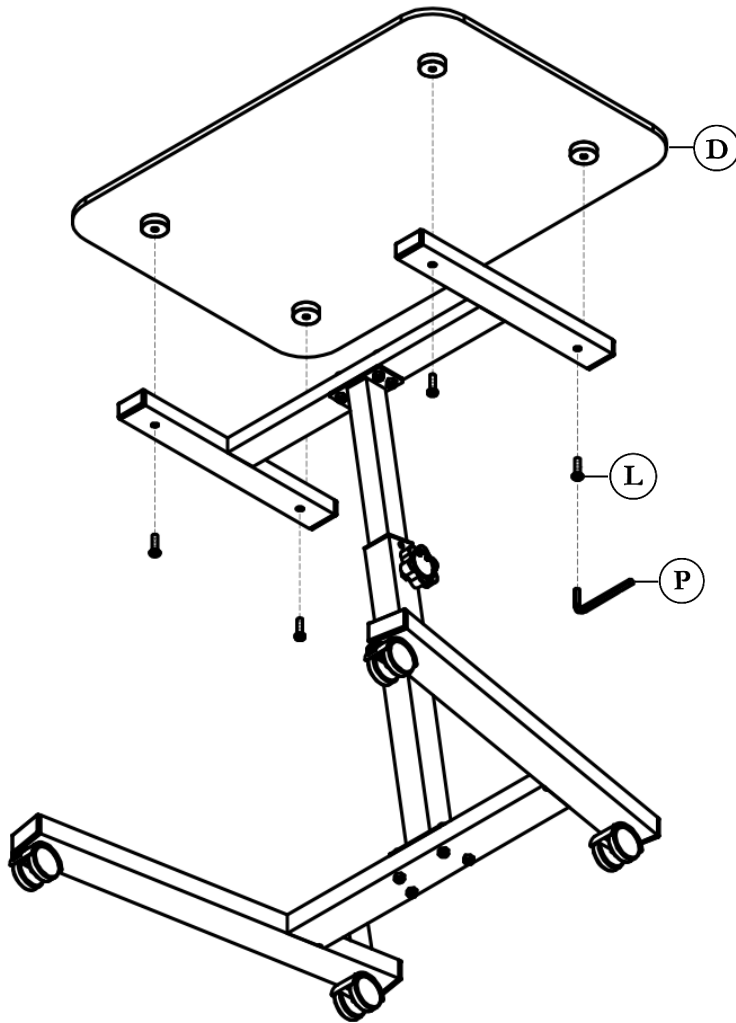

STEP 4.

Carefully place **TOP (D)** onto the **TOP FRAME (B)** and line up the screw holes.

Attach with **SHORT BOLTS (L)** through the bottom of the **TOP FRAME (B)** with **HEX KEY (P)**.

Congratulations!
**Enjoy your new Mobile Glass
Laptop Desk Cart!**

Use Instructions

- Move desk into desired position and lock the front casters.
- Turn the tension knob counter-clockwise to unlock height adjustment.
- Place hands on both sides of the top and pull up to lift; press down to lower the height.
- Turn tension knob clockwise until snug to secure the table height.

Safety

DO NOT put more than 15 lbs. (evenly distributed) on the desk top.
Remove items from desktop when adjusting height.

Customer Service Information

Telephone: (800) 323-5565

Fax: (310) 533-3899

Hours: 8:30 AM – 4:30 PM (PST)

Email: Support@SevilleClassics.com

Homepage: www.SevilleClassics.com