

Assembly Instructions

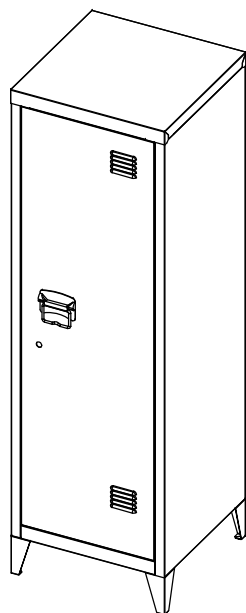

NOTE TO CUSTOMERS:

Please read instructions carefully. Be sure you have all parts before you begin to assemble.
Assemble this item on a clean, flat surface such as carpet to avoid scratching.
Tools required: screwdriver (not included).

WARNING !

DO NOT SIT OR STAND UP ON THE CABINET.
AVOID SCRATCHING THE SURFACE.
DO NOT KNOCK OR DRAG THE CABINET.
WHEN CLEANING THE CABINET SURFACE USE A DAMP CLOTH OR DRY CLEAN CLOTH.
DO NOT USE DETERGENT OR CHEMICAL CLEANERS.
MAXIMUM SAFE LOAD: TOP IS 15KGS;SHELF AND BOTTOM EACH IS 10KGS.
FAILURE TO FOLLOW THESE WARNING COULD RESULT IN SERIOUS INJURY.
A MILD ODOUR MAY BE PRESENT WHEN FIRST OPENING THE CARTON.
SIMPLY ALLOW TO AIR OUTSIDE AND THIS WILL DISSIPATE.

Instrucciones de montaje

NOTA AL CLIENTE:

Por favor lea las instrucciones cuidadosamente. Asegúrese de tener todas las partes antes de comenzar a ensamblar. Ensamble los componentes en una superficie limpia y plana, como una alfombra ara evitar rayones. Herramientas requeridas: Desarmador (NO INCLUIDO).

¡ADVERTENCIA!

NO SE SIENTE O SE PARE SOBRE EL GABINETE.
EVITE RAYAR LA SUPERFICIE.
NO GOLPEE O ARRASTRE EL GABINETE.
CUANDO LIMPIE EL GABINETE UTILICE UN PAÑO SUAVE O SECO.
NO USE DETERGENTE O LIMPIADORES QUÍMICOS.
CAPACIDAD MÁXIMA DE CARGA: PARTE SUPERIOR 15 KGS, PARTE INFERIOR 10 KGS.
NO SEGUIR LAS ADVERTENCIAS PUEDE RESULTAR EN LESIONES SERIAS.
UN OLORESUAVE PUEDE PRESENTARSE CUANDO ABRA EL EMPAQUE,
SOLAMENTE DEJE SALIR EL
AIRE Y ESTE OLORESUAVE SE DISIPARÁ.







Instruction de montage

Avertissement aux consommateurs :

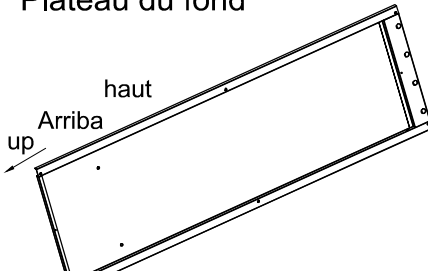
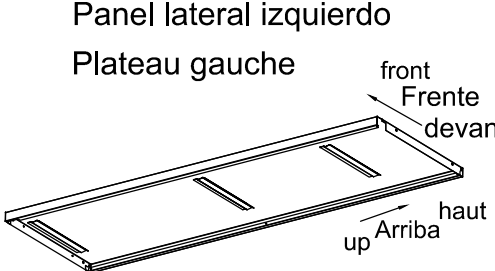
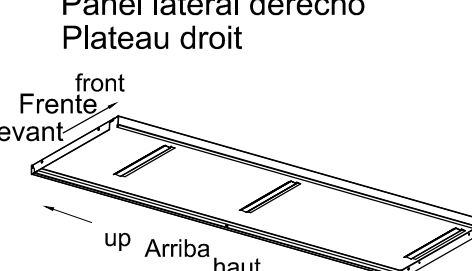
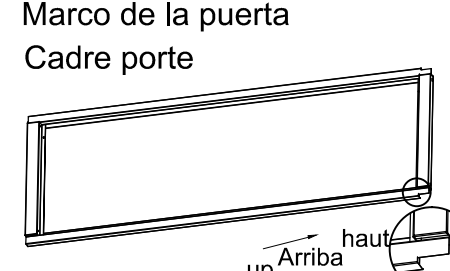
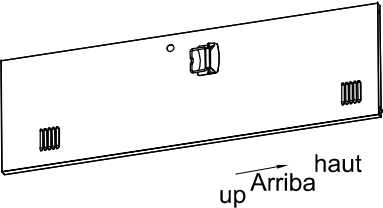
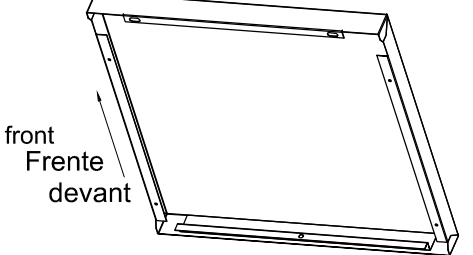
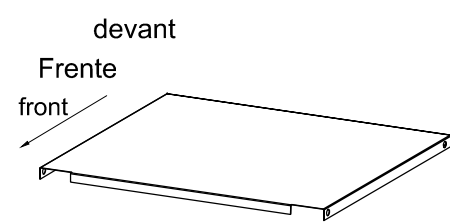
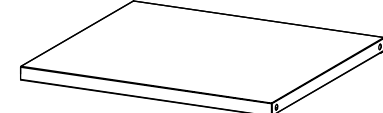
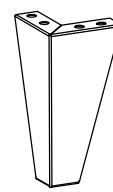
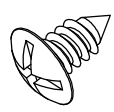
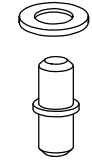
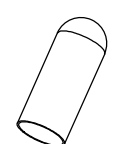
Lisez attentivement ce document. Avant d'entreprendre le montage, vérifiez que toutes les pièces sont bien fournies. Entrez le montage dans une surface propre et plane pour éviter le grattage, telle qu'une moquette.
Outils nécessaires : tournevis (non fourni).

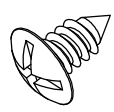
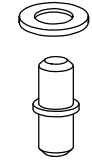
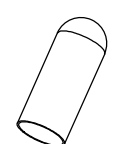
Précaution !

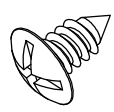
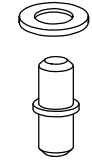
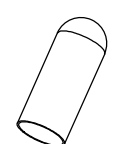
Ne pas vous mettre assis ni debout sur ce cabinet.
Eviter de gratter la surface.
Ne pas frapper ni tirer le cabinet.
Nettoyer la surface avec un chiffon humide.
Ne pas utiliser de nettoyeurs détergents ou chimiques.
Maximum capacité de charge : 15 kg sur le dessus, 10 kg de chaque sur l'étagère et le fond.
Une blessure grave serait possible en cas de l'ignorance desdites précautions.
La présence d'une mauvaise odeur serait possible lors de la première ouverture du carton.
Laisser le carton à l'extérieur aérer et l'odeur se dissipera.

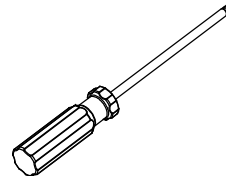
<p>A Back Panel Panel posterior Plateau du fond</p> 	<p>B Left Side Panel Panel lateral izquierdo Plateau gauche</p> 	<p>C Right Side Panel Panel lateral derecho Plateau droit</p> 	<p>D Door Frame Marco de la puerta Cadre porte</p> 												
<p>E Door Puerta Porte</p> 	<p>F Top Parte superior Dessus</p> 	<p>G Bottom Fondo Fond</p> 	<p>H Shelf*2 Estante*2 Etagère*2</p> 												
<p>I feet*4 Patas*4 Pied *4</p> 	<p>Hardware parts Partes de hardware Pièces</p> <table border="0"> <tr> <td data-bbox="739 1053 851 1165"></td> <td data-bbox="873 1021 1075 1197"> <p>A 1 28pcs A 1 28piezas A 1 28pcs</p> </td> <td data-bbox="1209 1021 1299 1181"></td> <td data-bbox="1366 1021 1568 1197"> <p>A 2 1pc A 2 1pieza A 2 1pc</p> </td> <td data-bbox="1680 1021 1792 1165"></td> <td data-bbox="1859 1021 2083 1197"> <p>A 3 4pcs A 3 4piezas A 3 4pcs</p> </td> </tr> <tr> <td data-bbox="716 1324 806 1404"></td> <td data-bbox="873 1276 1075 1436"> <p>A 4 4pcs A 4 4piezas A 4 4pcs</p> </td> <td data-bbox="1142 1292 1321 1420"></td> <td data-bbox="1366 1276 1590 1436"> <p>A 5 2pcs A 5 2piezas A 5 2pcs</p> </td> <td></td> <td></td> </tr> </table>				<p>A 1 28pcs A 1 28piezas A 1 28pcs</p>		<p>A 2 1pc A 2 1pieza A 2 1pc</p>		<p>A 3 4pcs A 3 4piezas A 3 4pcs</p>		<p>A 4 4pcs A 4 4piezas A 4 4pcs</p>		<p>A 5 2pcs A 5 2piezas A 5 2pcs</p>		
	<p>A 1 28pcs A 1 28piezas A 1 28pcs</p>		<p>A 2 1pc A 2 1pieza A 2 1pc</p>		<p>A 3 4pcs A 3 4piezas A 3 4pcs</p>										
	<p>A 4 4pcs A 4 4piezas A 4 4pcs</p>		<p>A 5 2pcs A 5 2piezas A 5 2pcs</p>												
<p>Tools Herramientas Outils</p>  <p>(Not included) (No incluido) (non fournis)</p>															

1

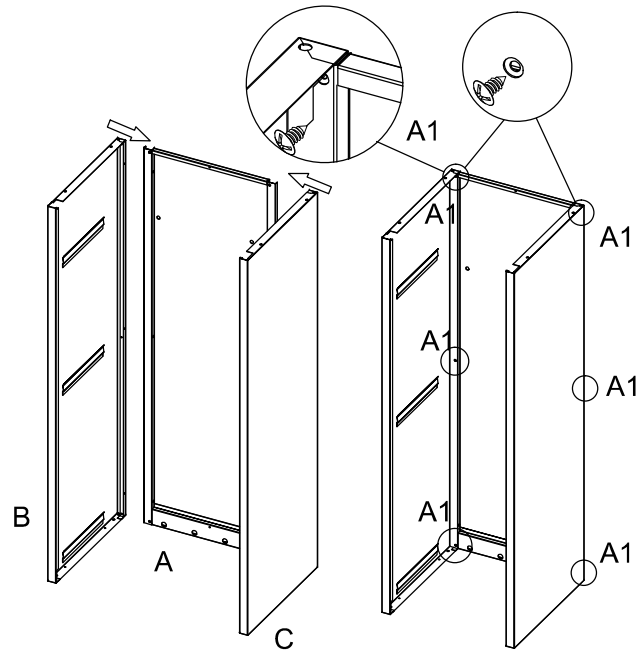

A1x6

2

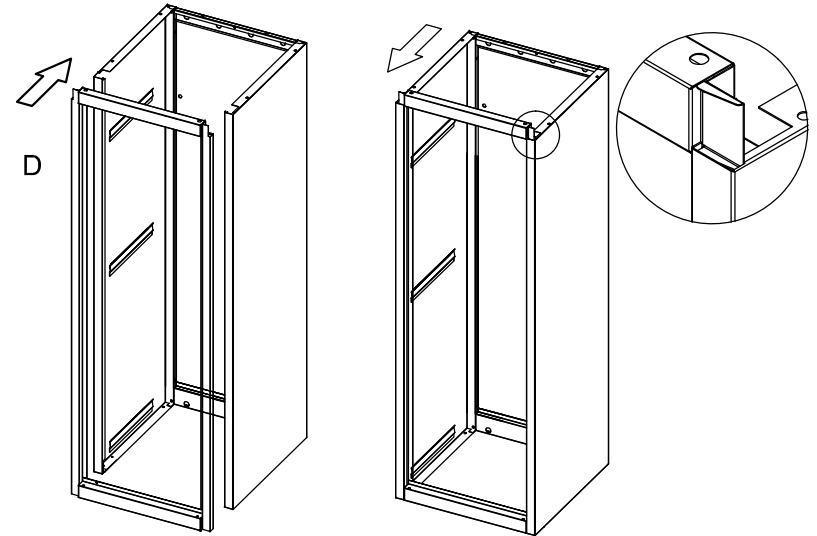

3

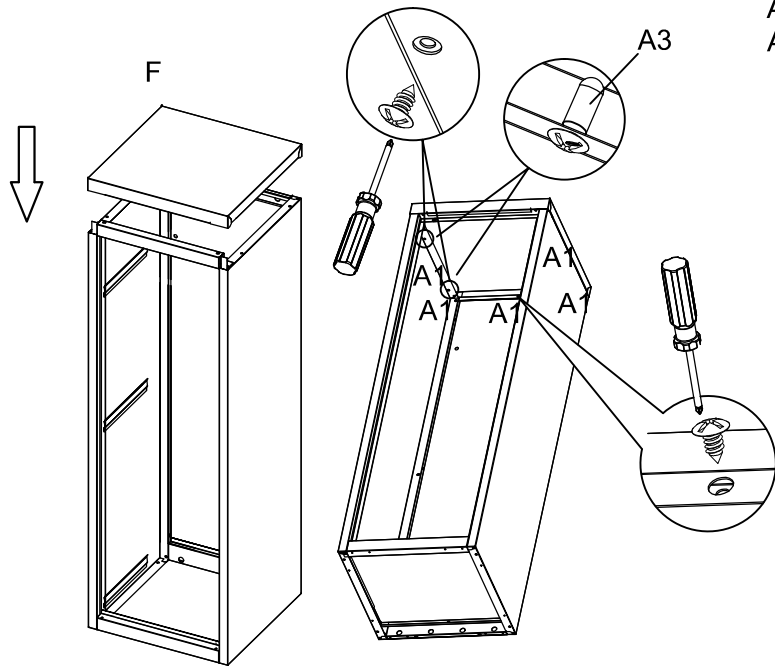

A1x5
A3x4

4

Please install G first, then install the below shelf, last install the upper shelf.

Instale primero G, luego instale el estante inferior, instale el estante superior finalmente.

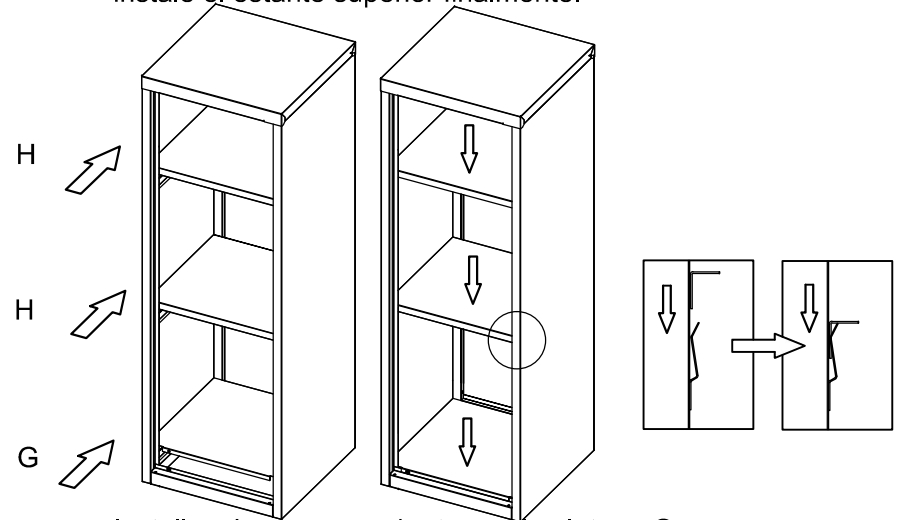

Installez dans un premier temps le plateau G, puis celui du milieu et celui du plus haut à la fin.

5

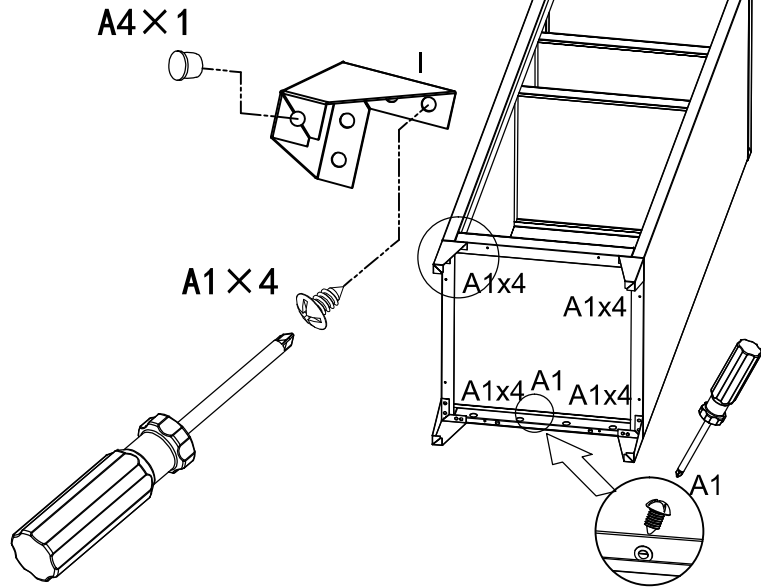

A1x17
A4x4

6

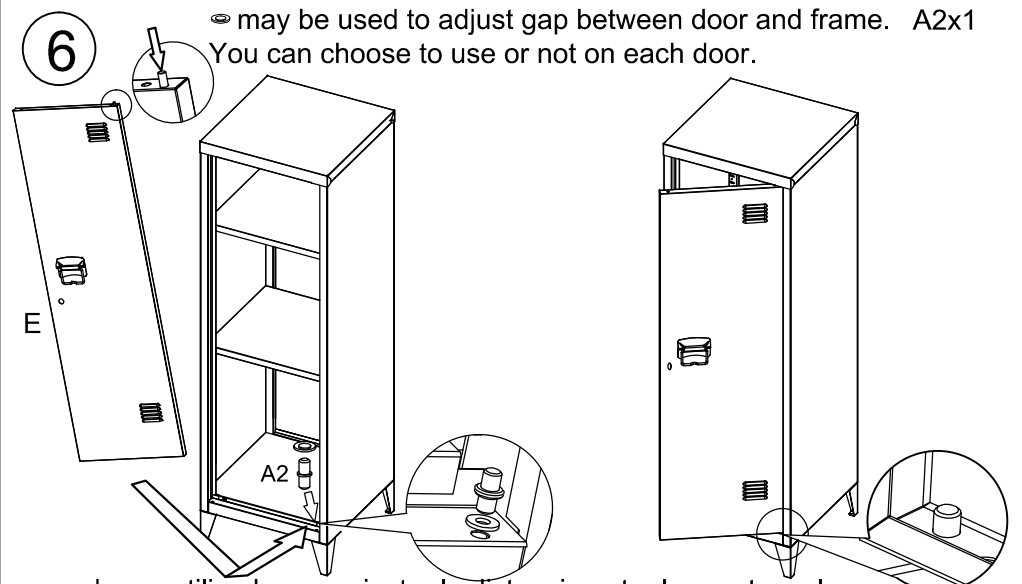

☞ may be used to adjust gap between door and frame. A2x1
You can choose to use or not on each door.

☞ puede ser utilizado para ajustar la distancia entre la puerta y el marco.
Usted puede optar por utilizar o no en cada puerta.
La pièce ☞ pourra servir à ajuster l'espace entre la porte et le cadre.
Lors du montage, le consommateur devra décider de s'en servir d'une seule ou plusieurs.

7

Using A5 through the several holes in the cabinet is fixed to the wall
El uso de A5 a través de los varios agujeros en el gabinete es para fijarse a la pared.
Fixez le cabinet contre le mur à l'aide de la pièce A5.

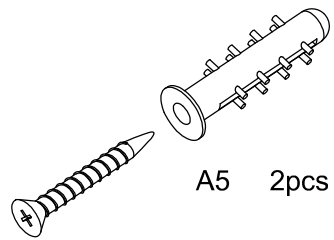
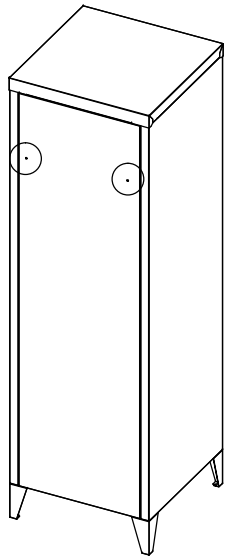

A5 2pcs

8

