

Instruction Manual

Tall Bookcase

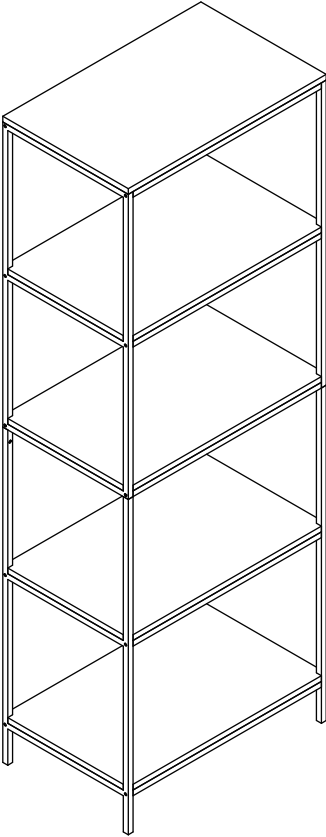

CONTENTS

Safety and care advice	1
Components	2
Assembly instructions	4
Copyright	12

⚠ SAFETY AND CARE ADVICE ⚠

PLEASE READ THESE INSTRUCTIONS CAREFULLY AND KEEP FOR FUTURE REFERENCE

- **Warning:** Please lift with care.
- Check you have all the components and tools listed on pages 2 and 3.
- Remove all fittings from the plastic bags and separate them into their groups.
- Keep children and animals away from the work area, small parts could choke if swallowed.
- Make sure you have enough space to lay out the parts before starting.
- Do not stand or put weight on the product, this could cause damage.
- Assemble the item as close to its final position (in the same room) as possible.

- Assemble on a soft level surface to avoid damaging the unit or your floor (use opened out unit carton).



- We do not recommend the use of power drill/drivers **for inserting screws**, as this could damage the unit. Only use hand screwdrivers.
- **Safety note:** If there is any chance of this unit being pulled over by children etc. it is recommended that the unit is secured to a wall using suitable fixings
- Dispose of all packaging carefully and responsibly.

CARE AND MAINTENANCE

- Only clean using a damp cloth and mild detergent, do not use bleach.
- From time to time check that there are no loose screws on this unit.

- This product should not be discarded with household waste. Take to your local authority waste disposal center.

Note *If required the next page can be cut out and used as reference throughout the assembly. Keep this page with these instructions for future reference.*

COMPONENTS

Please check you have all the panels listed below:

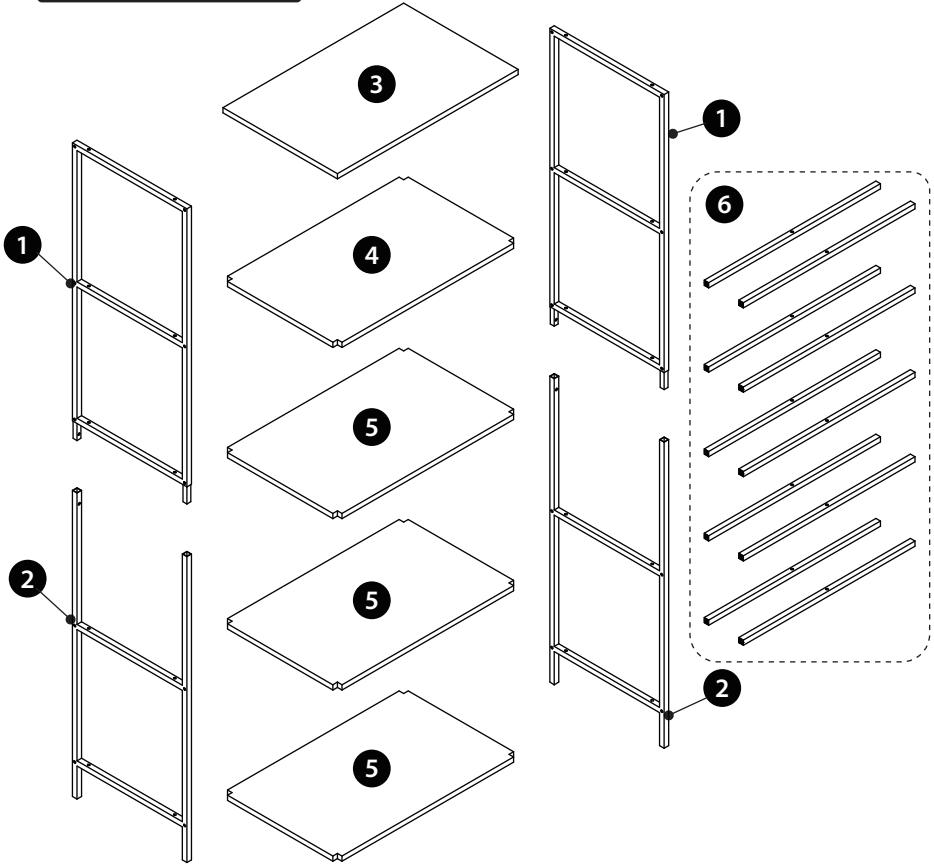

1 Upper frame	x2	4 Mid-layer board	x1
2 Lower frame	x2	5 Panel	x3
3 Top panel	x1	6 Bar	x10



COMPONENTS

Please check you have all the fittings listed below:

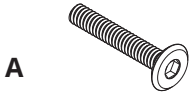

Screw ($\phi 6 \times 25$) x 50



Screw ($\phi 3 \times 12$) x 2



Screw ($\phi 6 \times 10$) x 4

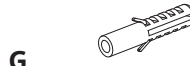

Wall plug ($\phi 6 \times 30$) x 2

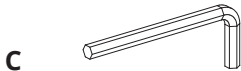

Allen wrench x 1



Screw ($\phi 4 \times 35$) x 2



Nylon rope x 2





Gasket ($\phi 12 / \phi 4$) x 4



ASSEMBLY INSTRUCTIONS

Step 1

B		4
C		1

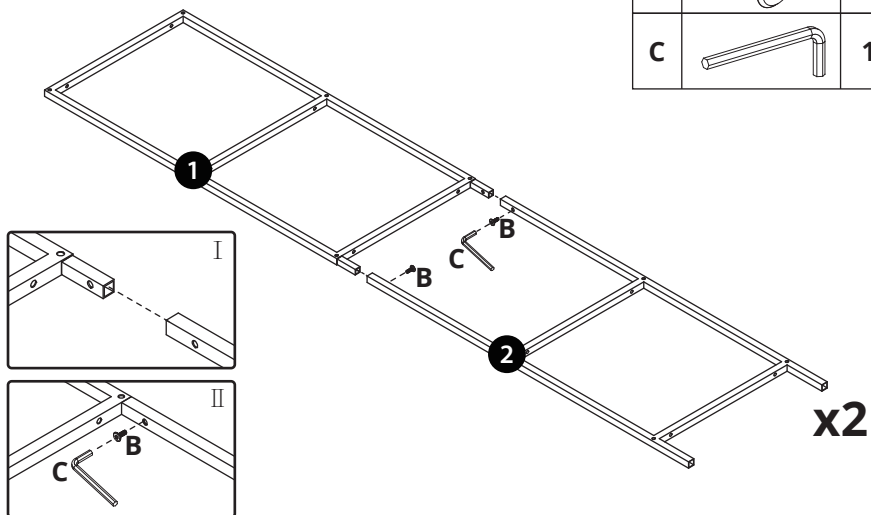

Step 2

A		10
---	---	----

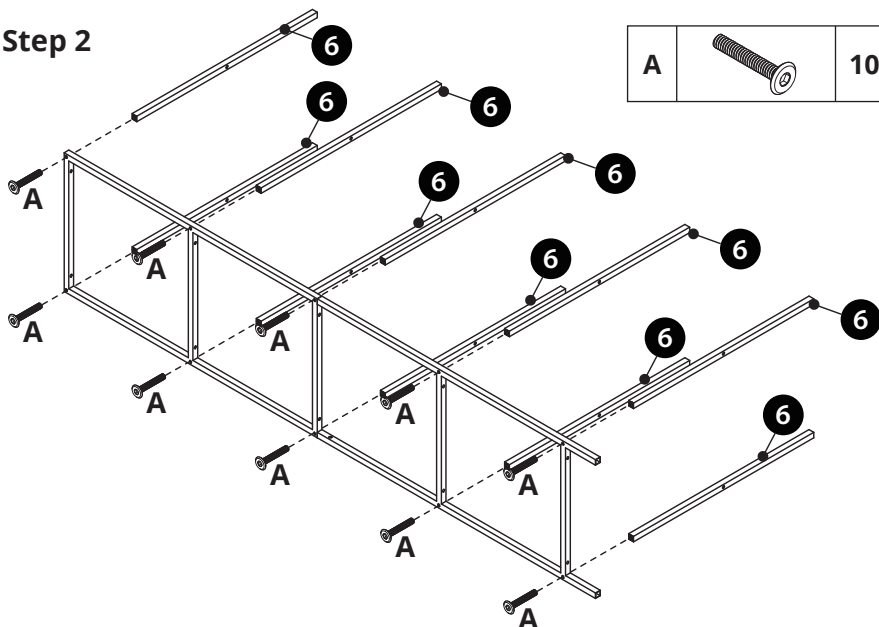

ASSEMBLY INSTRUCTIONS

Step 3

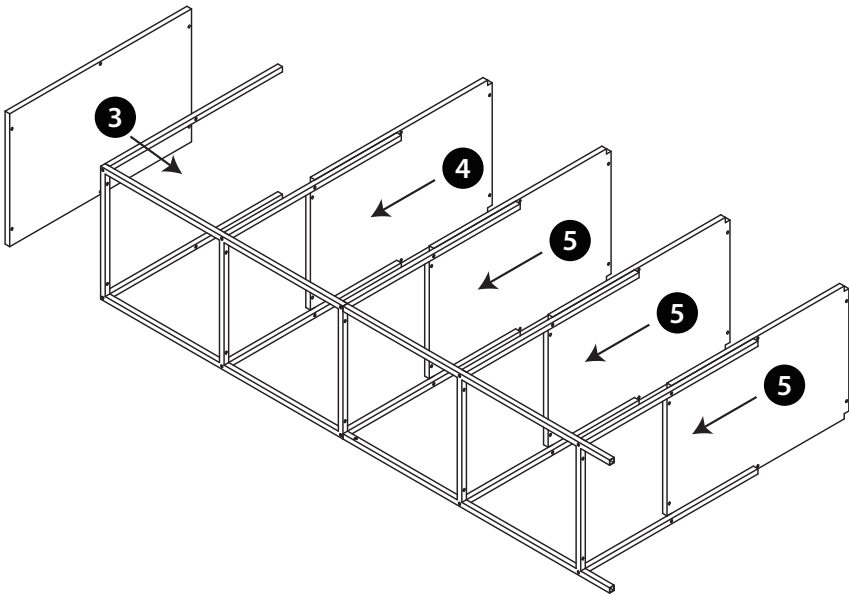

ASSEMBLY INSTRUCTIONS

Step 4

A		20
---	---	----

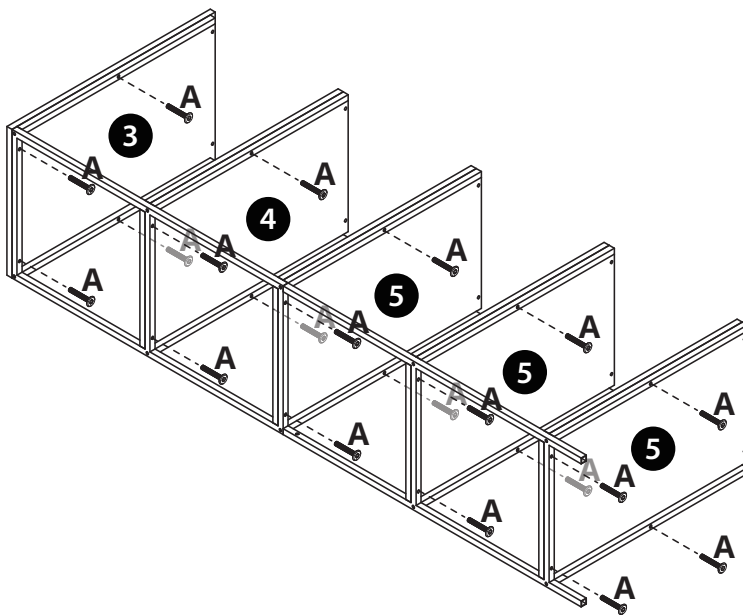

ASSEMBLY INSTRUCTIONS

Step 5

A		10
---	---	----

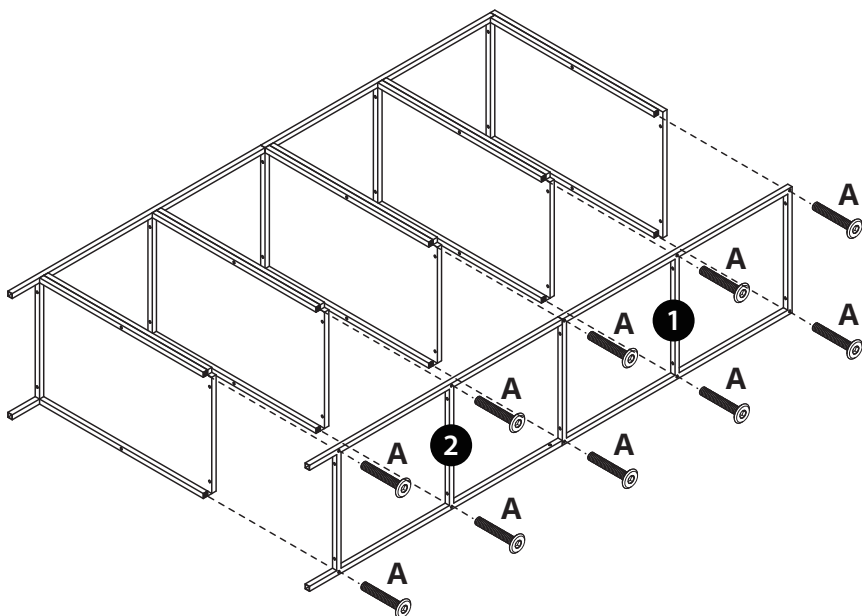

ASSEMBLY INSTRUCTIONS

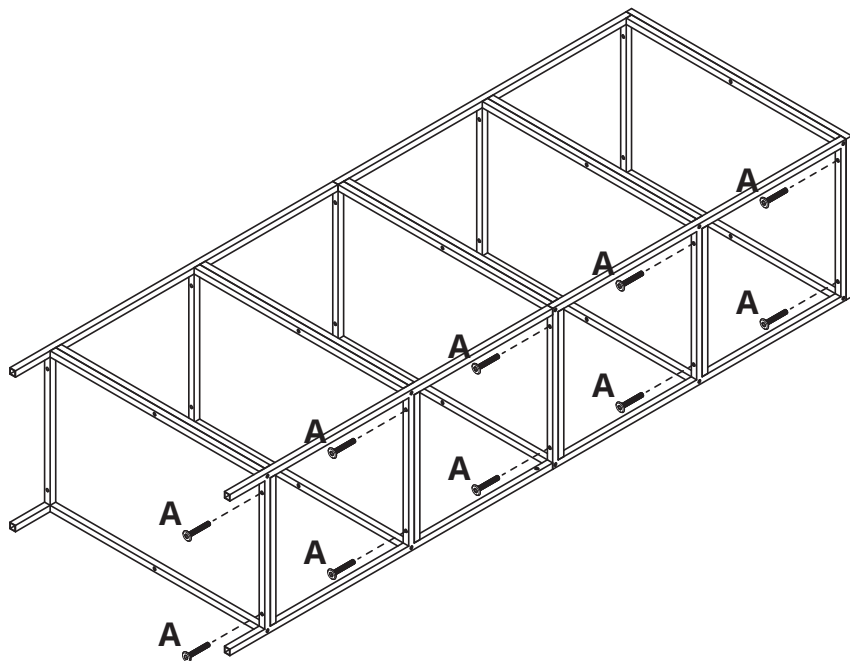

Step 6

A		10
---	---	----



ASSEMBLY INSTRUCTIONS

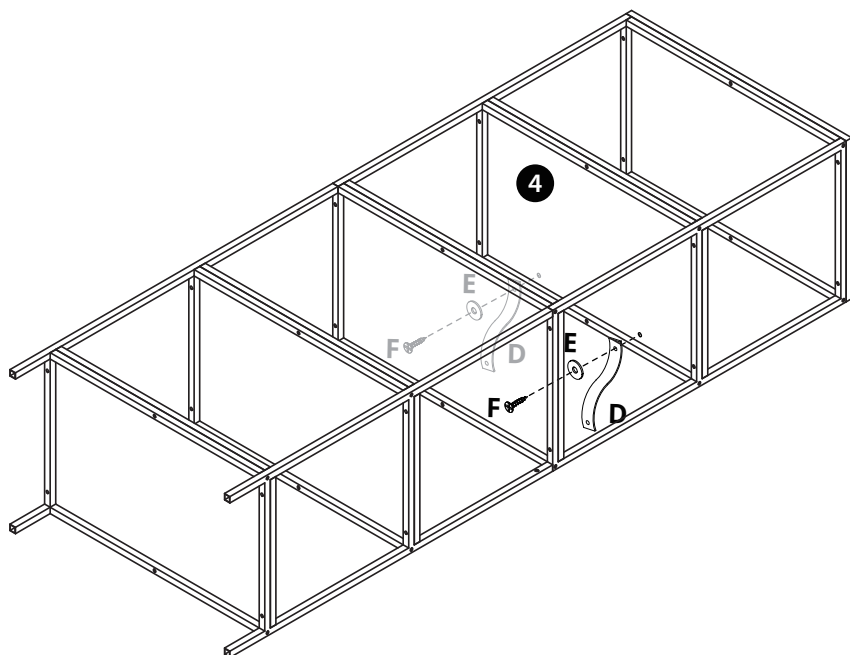

Step 7

D		2
E		2
F		2



ASSEMBLY INSTRUCTIONS

Step 8

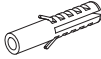
E		2
H		2
G		2

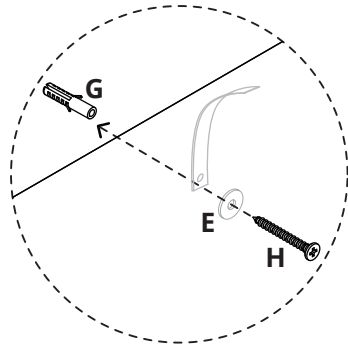
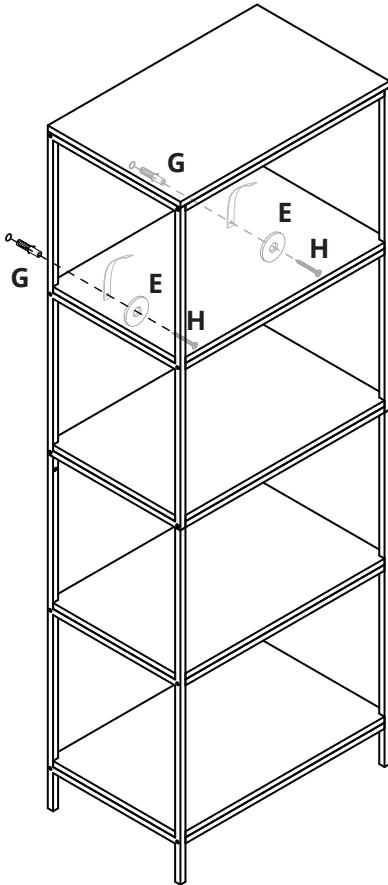

ASSEMBLY INSTRUCTIONS

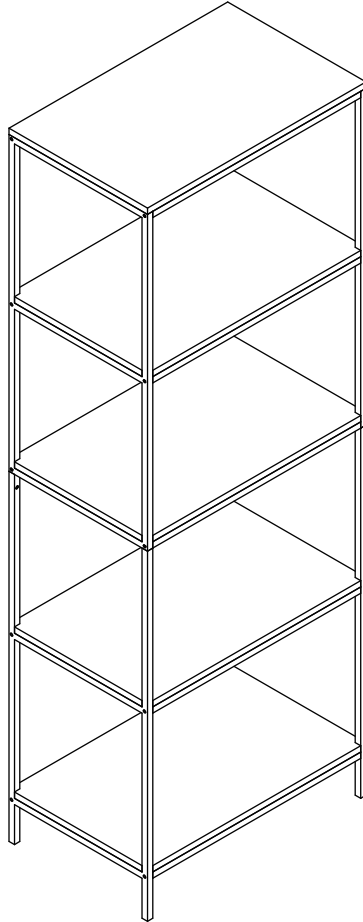

Congratulations! Now you have finished assembling the product.

IF YOU FIND A DEFECTIVE PART

We fully stock all parts and components. Any defective part can be quickly replaced. Take note of the defective part number in manual and we will arrange a quick replacement.

COPYRIGHT

All material in this instruction manual is copyrighted by AGTC Ltd.
Any unauthorised use may violate worldwide copyright, trademark and other laws.

Thank you for purchasing!

