



KEEP INSTRUCTIONS
FOR FUTURE USE





Assembly Instructions

SKU# 51030595

ASSEMBLY REQUIRES
TWO PEOPLE



Hardware and Tools

D	BOLT 0.31" x 4.72" Ø 8mm x 120mm QTY: 04	
E	WASHER 0.31" x 0.75" x 0.08" Ø 8mm x 19mm x 2mm QTY: 08	
F	BOLT 0.31" x 3.15" Ø 8mm x 80mm QTY: 04	
G	OPEN WRENCH K13 QTY: 01	

Before Starting:

1. Choose a clean, level, spacious assembly area. Avoid hard surfaces that may damage the product.
2. Always read the instructions carefully before beginning assembly to ensure that you have all required contents.
3. To prevent choking hazards, keep the packaging material out of reach of small children
4. Do not over tighten the bolts as this may damage the thread.
5. Use only vendor supplied hardware to assemble. Using unauthorized hardware could jeopardize the structural integrity of the item.
6. The use of power tools to aid in assembly is not recommended. Power tools can damage hardware and split wood.

Components:

A	TABLE TOP x 1
B	PEDESTAL PILLAR x 1
C	PEDESTAL FOOT x 1

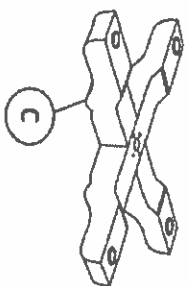
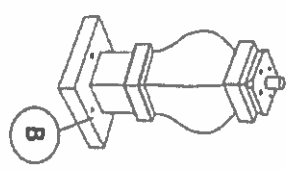
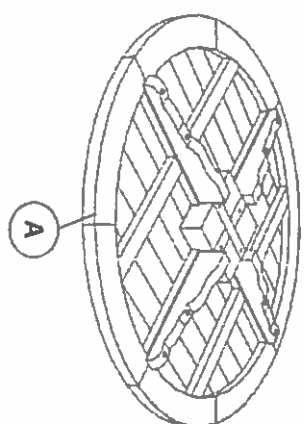

Step 1:

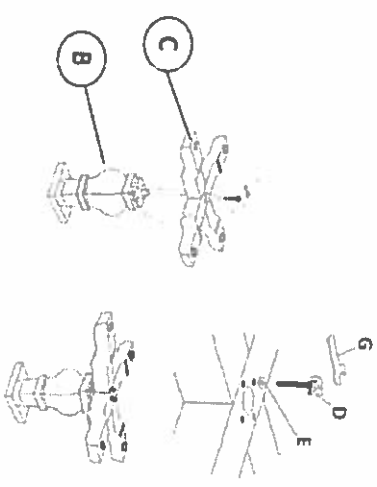

Assembly Pedestal Foot (C) into Pedestal Pillar (B) by using Open Wrench (G) to tighten Bolts (D) and Washers (E).

Assembly Instructions Continued

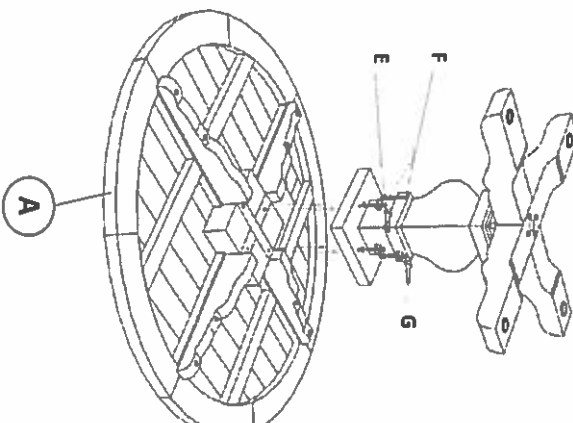
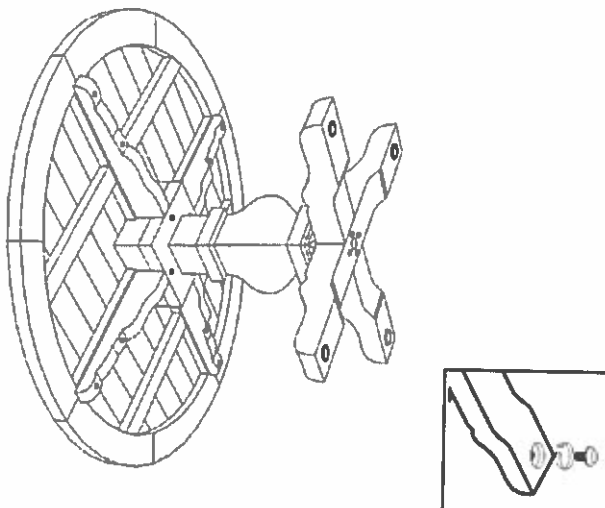
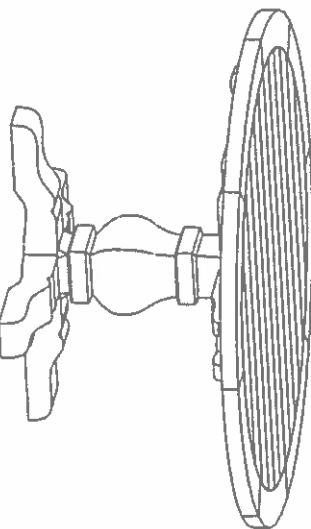
<p>Step 2:</p>  <p>- Connect the Leg set into the Table Top (A) by using Open Wrench (G) to tighten Bolts (F) and Washers (E).</p>	<p>Step 3:</p>  <p>- If the table doesn't sit level, please adjust the adjustable bolt under the legs.</p>	<p>Step 4:</p>  <p>- Carefully turn the table and stand on it leg. - Completed item</p>
-----------------------------------------------------------------------------------------------------------------------------------------------------------------------------------------------------------------------------	------------------------------------------------------------------------------------------------------------------------------------------------------------------------------------------------------	---------------------------------------------------------------------------------------------------------------------------------------------------------------------------------------