

VEVOR[®]

TOUGH TOOLS, HALF PRICE

Technical Support and E-Warranty Certificate www.vevor.com/support

PLASTIC PATIO LOUNGE CHAIRS USER MANUAL

We continue to be committed to provide you tools with competitive price.

"Save Half", "Half Price" or any other similar expressions used by us only represents an estimate of savings you might benefit from buying certain tools with us compared to the major top brands and does not necessarily mean to cover all categories of tools offered by us. You are kindly reminded to verify carefully when you are placing an order with us if you are actually saving half in comparison with the top major brands.

VEVOR[®]

TOUGH TOOLS, HALF PRICE

PLASTIC PATIO LOUNGE CHAIRS

MODEL: TY04-4/5/6 (GRAY , BROWN , WHITE)



NEED HELP? CONTACT US!

Have product questions? Need technical support? Please feel free to contact us:

Technical Support and E-Warranty Certificate
www.vevor.com/support

This is the original instruction, please read all manual instructions carefully before operating. VEVOR reserves a clear interpretation of our user manual. The appearance of the product shall be subject to the product you received. Please forgive us that we won't inform you again if there are any technology or software updates on our product.



Warning-To reduce the risk of injury, user must read instructions manual carefully.

INSTRUCTIONS

Thank you very much for choosing this product. Please read all of the instructions before using it. The information will help you achieve the best possible results.

PLEASE NOTE! Drawings in this manual are for illustration purposes only and in some details may differ from the actual product.

- ◆ Our clear, easy-to-follow, step-by-step instructions will guide you through the project from start to finish.
- ◆ Do not skip any steps. It is of utmost importance to assemble all of the parts according to the directions..Be very careful when folding chair to avoid smashing your hands or fingers.
- ◆ Item identification: For ease of identification, all parts are labeled to correspond to the step number in which the part is used.

IMPORTANT:

- Read following instructions carefully before using the lounge chair.Keep fingers away from hinged area of the lounge chair.Please contact customer service if you have any problems or discover any missing parts.
- Use the lounge chair on a flat not-slippery surface only.
- Regularly check all the fittings. Tighten them if they are loose.

WARNING:

- Keep all children and pets away from assembly area. Children and pets should be supervised while the product is being assembled..The assembled product should be located at least 6 feet (2 m) from any obstruction such as fence, garage, house, overhanging branches, laundry lines or electrical wires.





- Some parts may contain sharp edges. Wear protective gloves if necessary during assembly.
- When assembling and using this product, basic safety precautions should always be followed to reduce the risk of personal injury and damage to equipment.
- Check all bolts for tightness before and during usage.



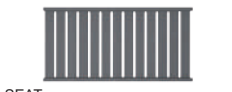

SAVE THESE INSTRUCTIONS

TECHNICAL PARAMETERS





Model	TY04-4/5/6		
Type	Plastic Patio Lounge Chair		
Load Bearing	400 lbs		
Color	Gray	Brown	White
Material	HDPE		
Backrest adjustment gear	5		



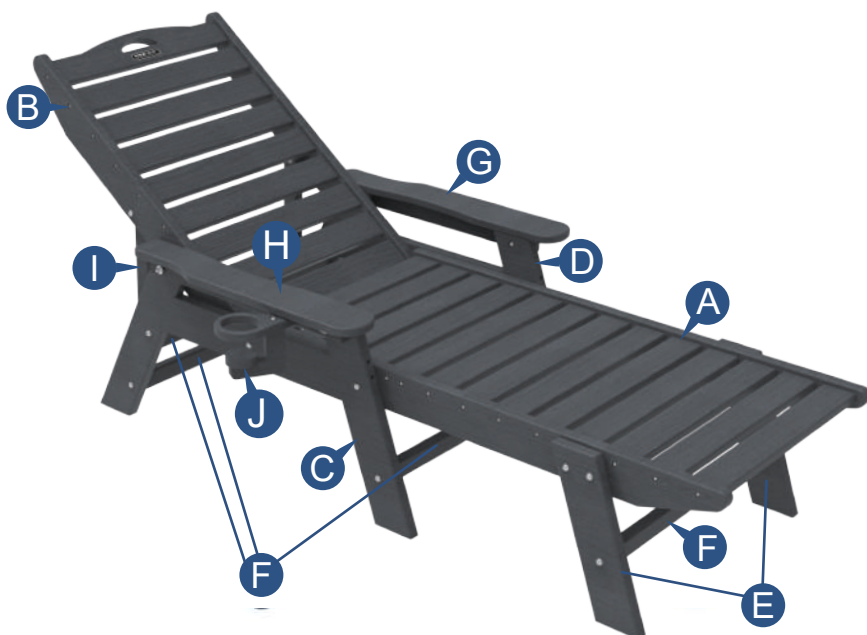

PARTS LIST

Item No.	Reference Image	Qty
A	 SEAT	X 1
B	 BACKREST	X 1
C	 BACK LEFT LEG	X 1
D	 BACK RIGHT LEG	X 1
E	 FRONT LEG	X 2

Item No.	Reference Image	Qty
F	 RAIL	X 4
G	 RIGHT ARM	X 1
H	 LEFT ARM	X 1
I	 SUPPORT FRAME	X 1
J	 CUP BOTTOM	X 1



Item No.	Reference Image	Qty
1	M6x55mm 	X 4
2	M6x60mm 	X 12
3	M6x50mm 	X 8
4	M6x40mm 	X 1

Item No.	Reference Image	Qty
5	M6 NUT 	X 16
6	M6xWASHER 	X 16
7	T WRENCH 	X 1
8	WRENCH 	X 1

ASSEMBLY

STEP 1

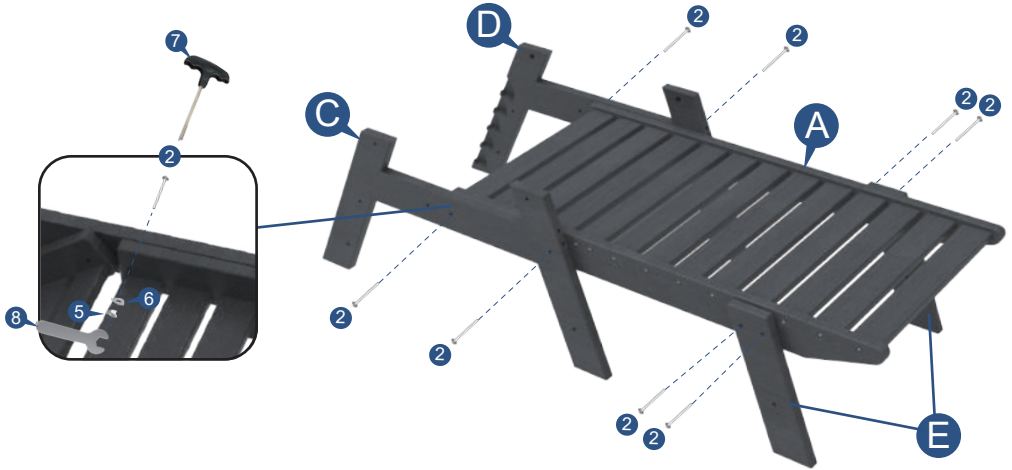

STEP 2

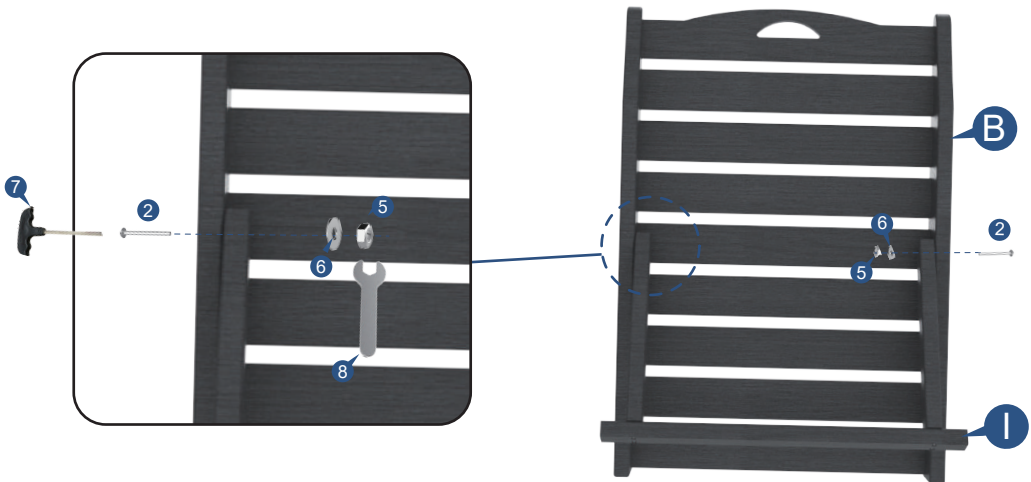
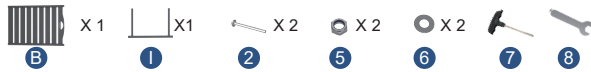

*Repeat the same operation on the other side of the chair.





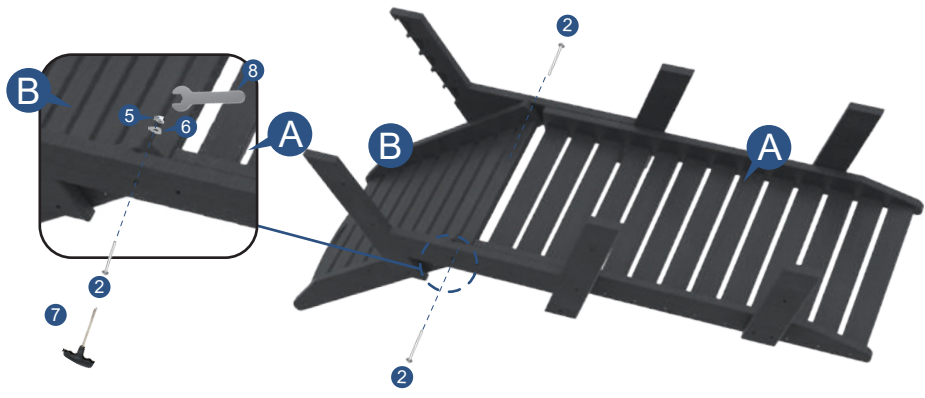



STEP 3

-  X2
-  X2
-  X2
- 
- 



*Repeat the same operation on the other side of the chair.

STEP 4

-  X1
-  X1
-  X1
-  X4
-  X1
-  X4
-  X4
- 
- 

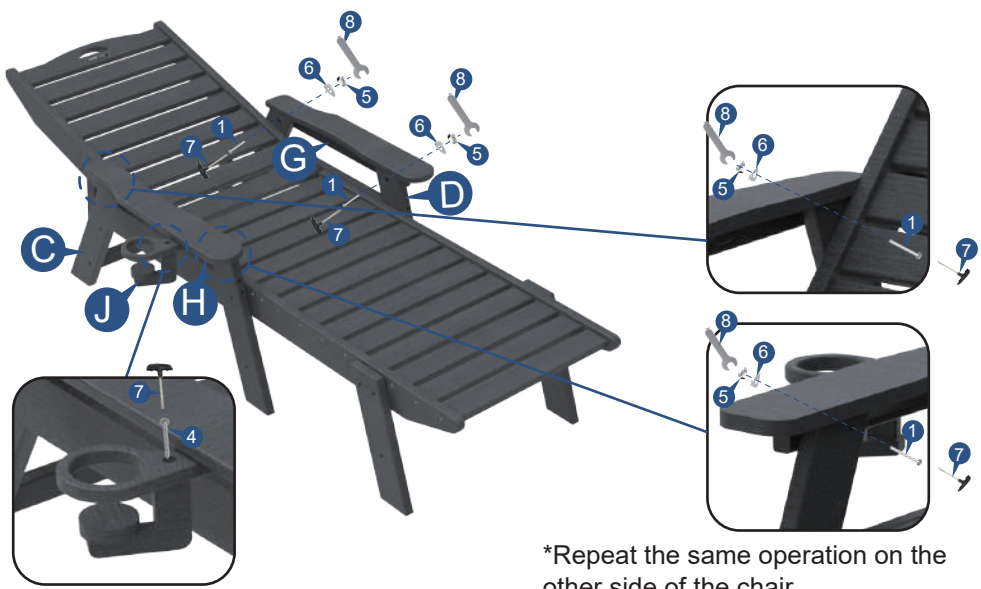

*Repeat the same operation on the other side of the chair.

STEP 5

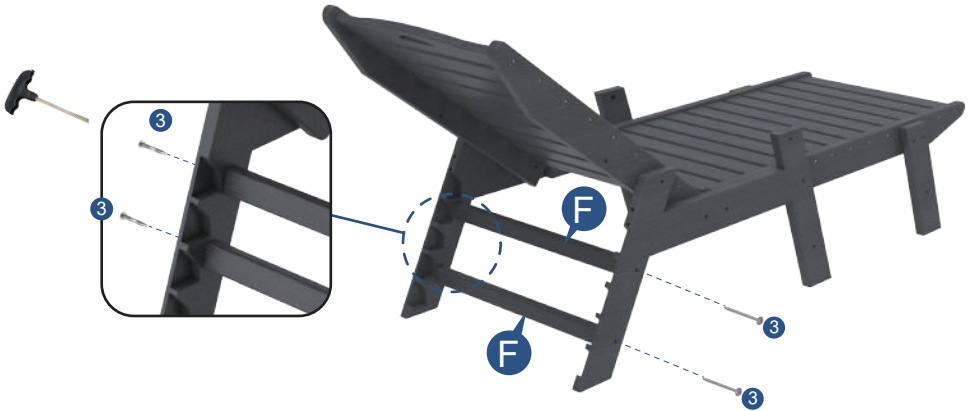

*Repeat the same operation on the other side of the chair.

STEP 6



*Repeat the same operation on the other side of the chair.

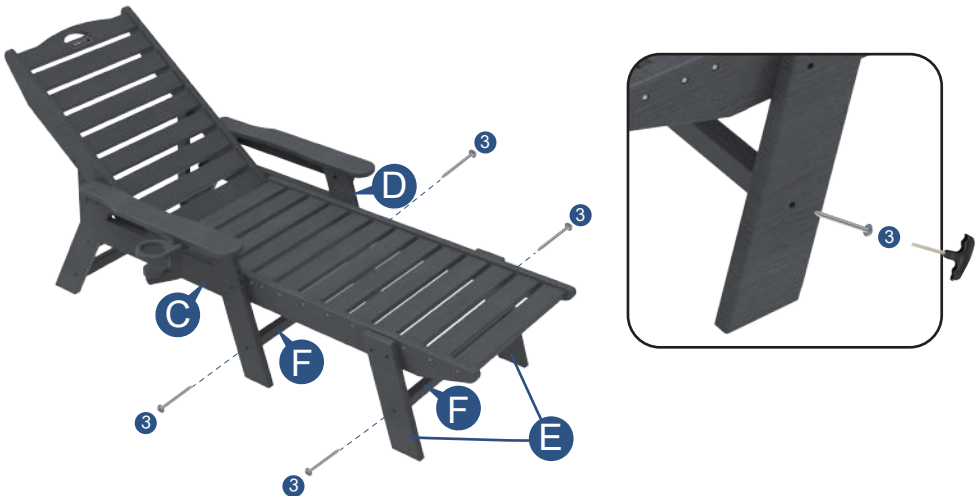

CARE AND MAINTENANCE

DO NOT:

- Avoid harsh,abrasive cleaners, and other corrosive chemicals.
- Do not use metal scouring pad for cleaning. Most stains can be removed by using a mild soap and a soft bristled brush.
- Avoid placing any direct heat source on or near the surface.
- Leaving any glassware on the Side Table under sunlight may result in burn marks on the surface. Please use a coaster when placing glassware on the Side Table.

CLEANING TIPS:

Even NALONE gets dirty - here are some ways to help keep it clean :

For a quick clean:Simply wipe down with soap and water.

For a deeper clean:

You'll need:

- 1/2 bleach and 1/3 water solution
- clean cloth
- soft bristle brush

Wipe on solution with your cloth and let it sit on the lumber for a few minutes (this will not affect the color) Then, loosen any dirt and debris that may catch in surface grooves with a soft bristle brush: hose down to rinse.

Manufacturer:Shanghaimuxinmuyeyouxiangongsi

Address: Shuangchenglu 803nong11hao1602A-1609shi, baoshanqu, shanghai 200000 CN.

Imported to AUS: SIHAO PTY LTD. 1 ROKEVA STREETEASTWOOD NSW 2122 Australia

Imported to USA: Sanven Technology Ltd. Suite 250, 9166 Anaheim Place, Rancho Cucamonga, CA 91730

EC	REP
-----------	------------

E-CrossStu GmbH

Mainzer Landstr.69, 60329 Frankfurt am Main.

UK	REP
-----------	------------

YH CONSULTING LIMITED.

C/O YH Consulting Limited Office 147, Centurion House,
London Road, Staines-upon-Thames, Surrey, TW18 4AX



Technical Support and E-Warranty Certificate
www.vevor.com/support

VEVOR[®]
TOUGH TOOLS, HALF PRICE

RS

VEVOR[®]

TOUGH TOOLS, HALF PRICE

PLASTIK

S

-4/5/6



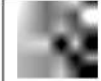



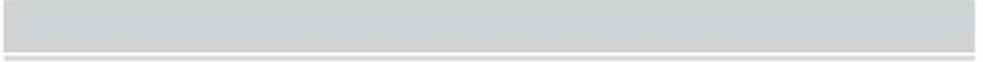







A long, empty rectangular box with a thin black border, occupying the top right portion of the page. It is currently blank.













	$-\frac{4}{5/6}$		

Artikelnr.	Referenzbild	Menge
A	 SITZ	X 1
B	 RÜCKENLEHNE	X 1
C	 LINKES HINTERES BEIN	X 1
D	 RECHTES HINTERES BEIN	X 1
E	 VORDERBEIN	X 2

Artikel-Nr.	Referenzbild	Menge
F	 SCHIENE	X 4
G	 RECHTER ARM	X 1
H	 LINKER ARM	X 1
	 Stützrahmen	X 1
J	 Becherboden	X 1



Artikel-Nr.	Referenzbild	Menge
1	M6x55mm 	X 4
2	M6x60mm 	X 12
3	M6x50mm 	X 8
4	M6x40mm 	X 1

Artikelnr.	Referenzbild	Menge
5	M6 Mutter 	X 16
6	M6xUNTERLEGSCHIEBE 	X 16
7	T-SCHLÜSSEL 	X 1
8	SCHLÜSSEL 	X 1

SCHRITT 1

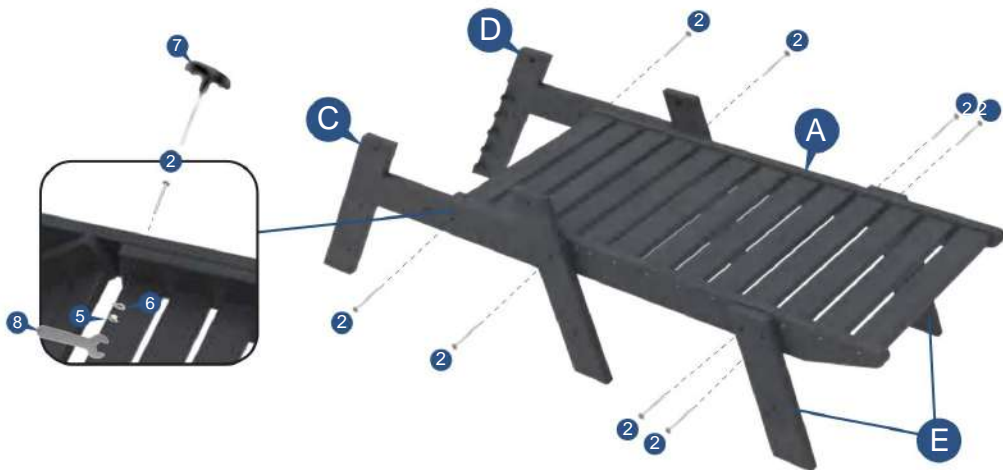

SCHRITT 2

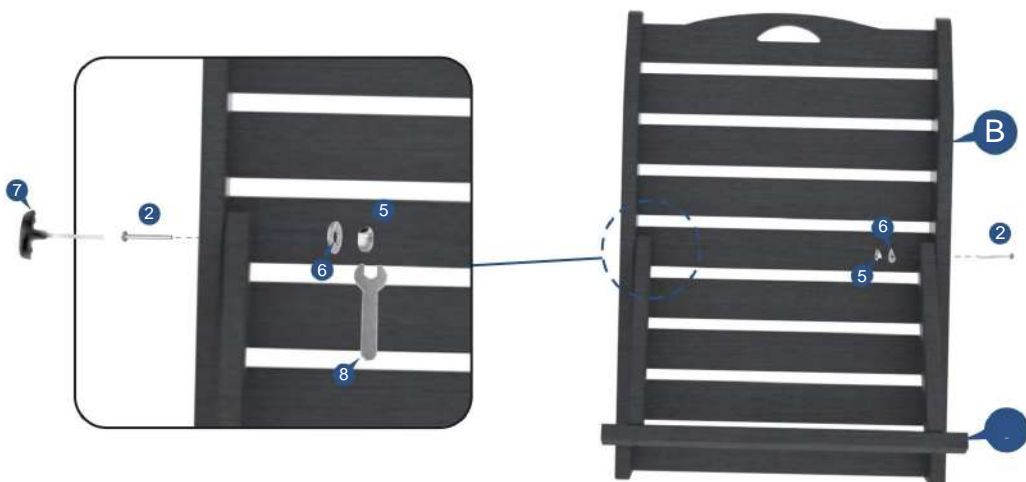

*Wiederholen Sie den gleichen Vorgang auf der anderen Seite des Stuhls.

SCHRITT 3

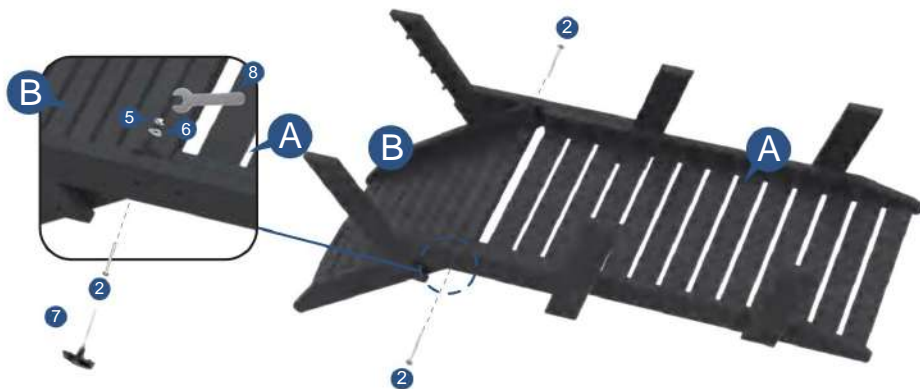

*Wiederholen Sie den gleichen Vorgang auf der anderen Seite des Stuhls.

SCHRITT 4



*Wiederholen Sie den gleichen Vorgang auf der anderen Seite des Stuhls.

SCHRITT 5

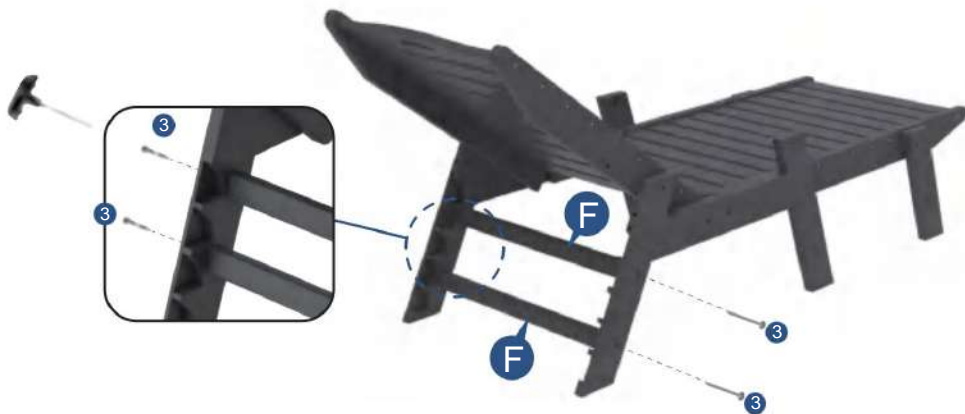

*Wiederholen Sie den gleichen Vorgang auf der anderen Seite des Stuhls.

SCHRITT 6



*Wiederholen Sie den gleichen Vorgang auf der anderen Seite des Stuhls.



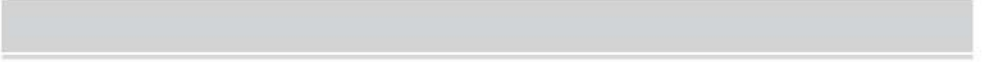



VEVOR®
TOUGH TOOLS, HALF PRICE

VEVOR[®]
TOUGH TOOLS, HALF PRICE

RS

VEVOR[®]
TOUGH TOOLS, HALF PRICE

PLASTIQUE

S

-4/5/6



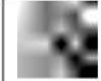



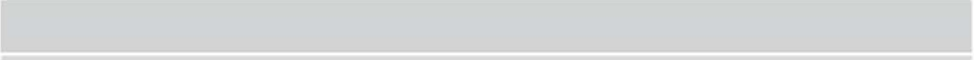







A long, empty horizontal rectangular box, likely a text input field or a placeholder for a long line of text.













	$-\frac{4}{5/6}$		

Numéro d'article	Image de référence	Qté
UN	 SIÈGE	X 1
B	 DOSSIER	X 1
C	 JAMBE ARRIÈRE GAUCHE	X 1
D	 JAMBE ARRIÈRE DROITE	X 1
E	 PATTE AVANT	X 2

Numéro d'article	Image de référence	Qté
F	 RAIL	X 4
G	 BRAS DROIT	X 1
H	 BRAS GAUCHE	X 1
	 CADRE DE SUPPORT	X 1
J	 FOND DE TASSE	X 1



Numéro d'article	Image de référence	Qté
1	M6x55mm 	X 4
2	M6x60mm 	X 12
3	M6x50mm 	X 8
4	M6x40mm 	X 1

Numéro d'article	Image de référence	Qté
5	ÉCROU M6 	X 16
6	M6×RONDELLE 	X 16
7	CLÉ EN T 	X 1
8	CLÉ 	X 1

ÉTAPE 1

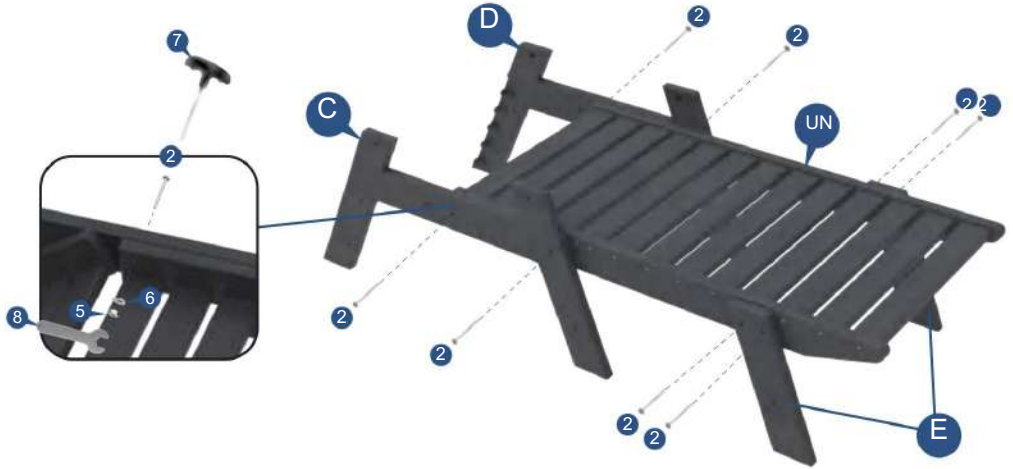
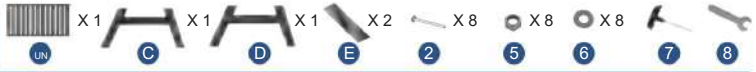

ÉTAPE 2

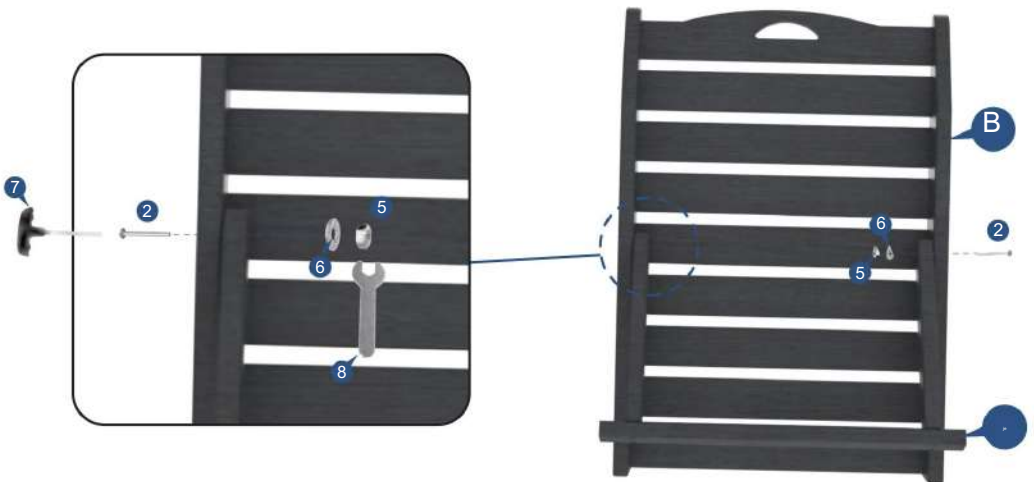

*Répétez la même opération de l'autre côté de la chaise.

ÉTAPE 5

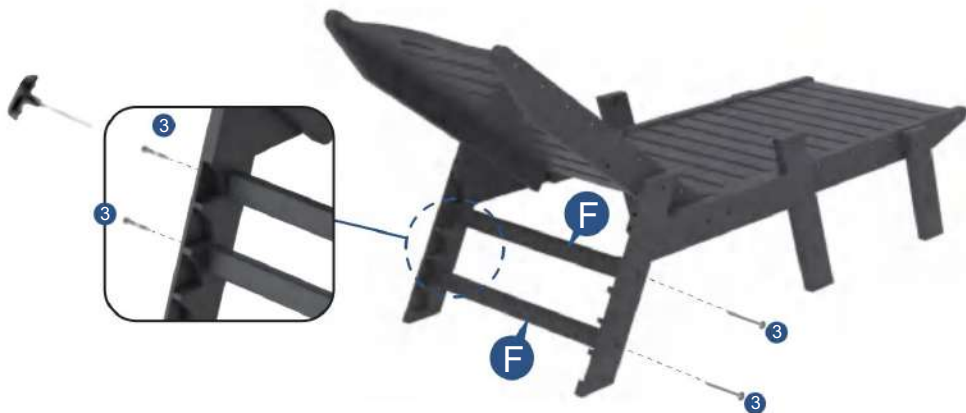

*Répétez la même opération de l'autre côté de la chaise.

ÉTAPE 6



*Répétez la même opération de l'autre côté de la chaise.

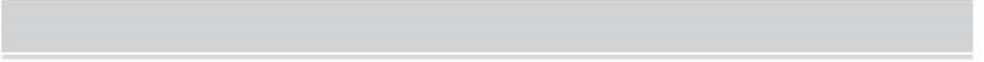



VEVOR[®]
TOUGH TOOLS, HALF PRICE

VEVOR[®]

TOUGH TOOLS, HALF PRICE

RS

VEVOR®

TOUGH TOOLS, HALF PRICE

PLASTIC

S

-4/5/6

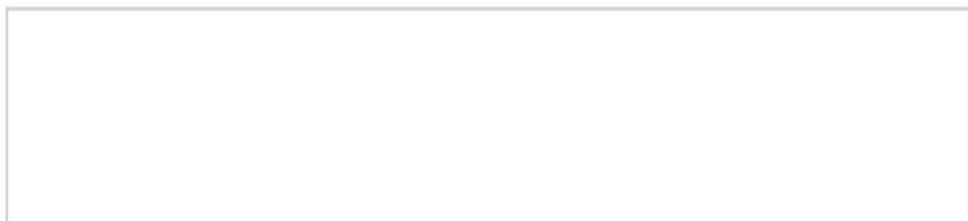

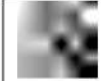





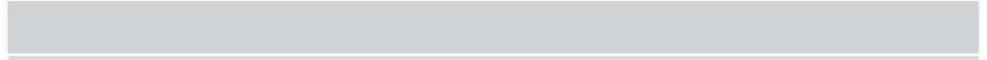





A long, empty rectangular box, likely a text input field or a placeholder for content, spanning most of the width of the page.











	$-\frac{4}{5/6}$		

Artikelnr.	Referentie afbeelding	Aantal
A	 STOEL	X1
B	 RUGLEUNING	X1
C	 ACHTERSTE LINKERBEEN	X1
D	 ACHTERKANT RECHTERBEEN	X1
E	 VOORSTE BEEN	X2

Artikelnr.	Referentie afbeelding	Aantal
F	 SPOOR	X4
G	 RECHTERARM	X1
H	 LINKERARM	X1
I	 ONDERSTEUNINGSFRAME	X1
J	 KOP ONDERKANT	X1



Artikelnr.	Referentie afbeelding	Aantal
1	M6x55mm 	X4
2	M6x60mm 	X12
3	M6x50mm 	X8
4	M6x40mm 	X1

Artikelnr.	Referentie afbeelding	Aantal
5	M6 MOER 	X16
6	M6xRING 	X16
7	T-SLEUTEL 	X1
8	MOERSLEUTEL 	X1

STAP 1

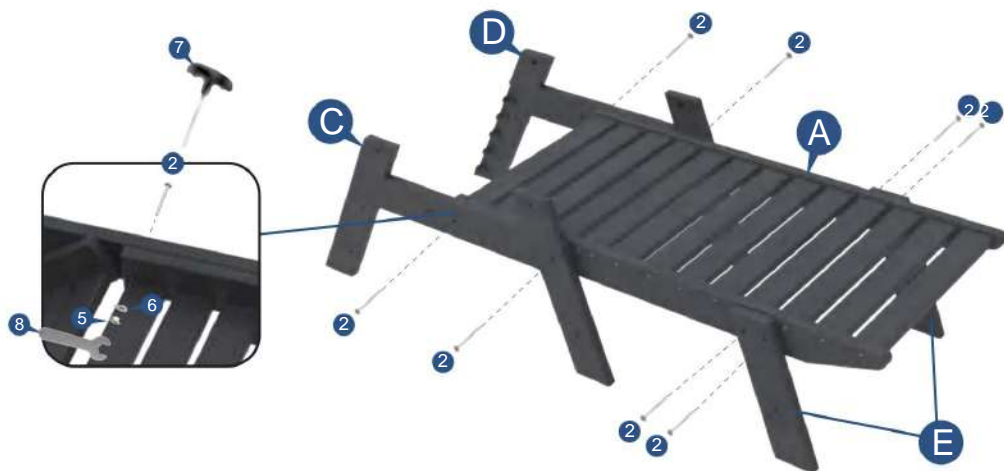

STAP 2

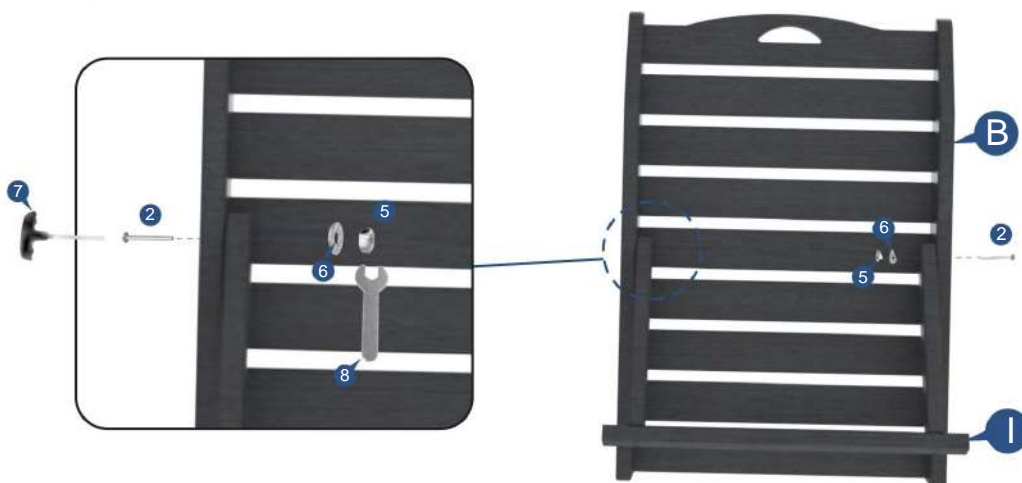

*Herhaal dezelfde handeling aan de andere kant van de stoel.

STAP 3

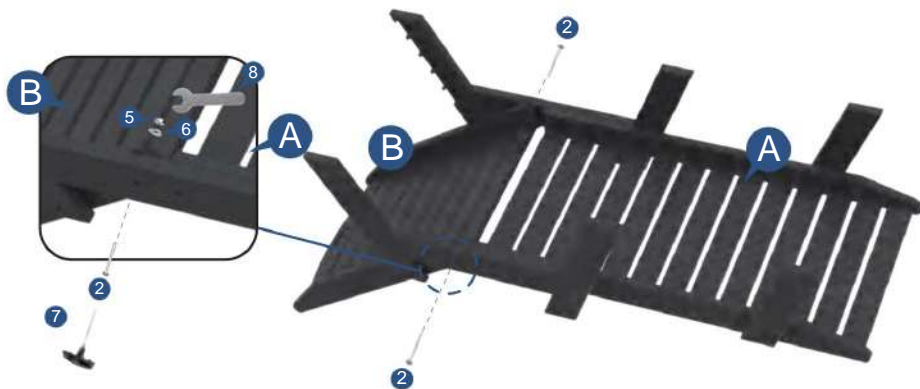

*Herhaal dezelfde handeling aan de andere kant van de stoel.

STAP 4



*Herhaal dezelfde handeling aan de andere kant van de stoel.

STAP 5

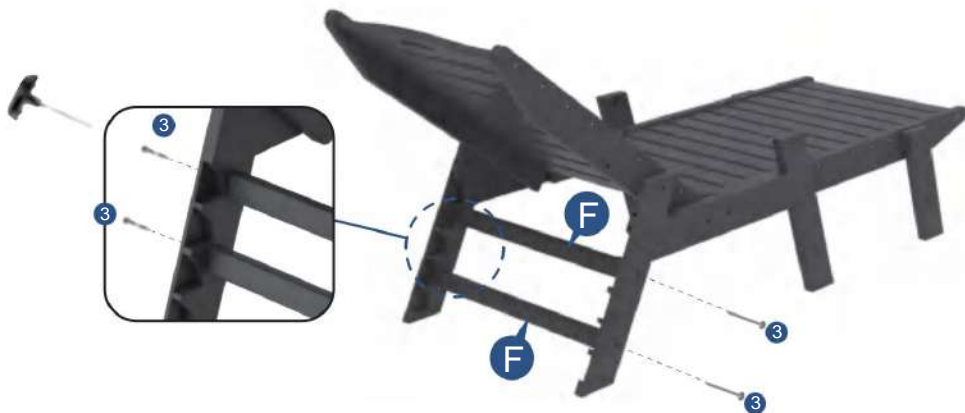

*Herhaal dezelfde handeling aan de andere kant van de stoel.

STAP 6



*Herhaal dezelfde handeling aan de andere kant van de stoel.



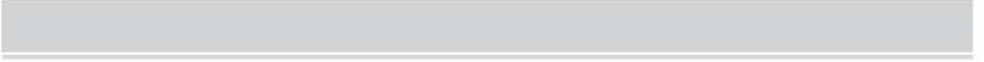



VEVOR[®]
TOUGH TOOLS, HALF PRICE

VEVOR[®]
TOUGH TOOLS, HALF PRICE

RS

VEVOR[®]

TOUGH TOOLS, HALF PRICE

PLAST

S

-4/5/6

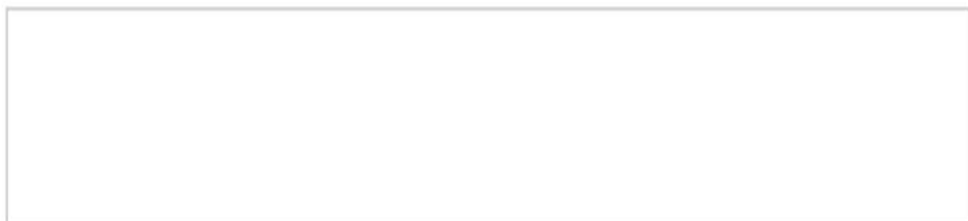

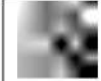



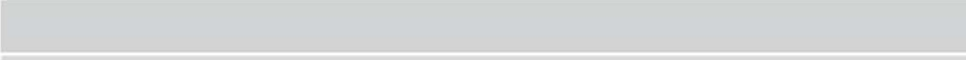

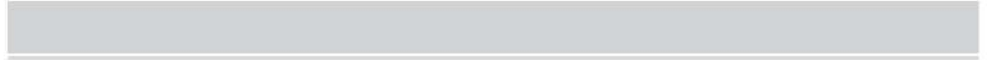
A long, empty horizontal rectangular box, likely a text input field, spanning most of the width of the page.











	$-\frac{4}{5/6}$		

Artikelnummer	Referensbild	Antal
En	 PLATS	1 st
B	 RYGGSTÖD	1 st
C	 VÄNSTER BAKRE BEN	1 st
D	 BAKSIDAN HÖGER BEN	1 st
E	 FRAMBEN	2 st

Artikelnummer	Referensbild	Antal
F	 JÄRNVAG	4 st
G	 HÖGER ARM	1 st
H	 VÄNSTER ARM	1 st
	 STÖDRAM	1 st
J	 KOPPEN BOTTEN	1 st



Artikelnummer	Referensbild	Antal
1	M6x55mm 	4 st
2	M6x60mm 	X 12
3	M6x50mm 	X8
4	M6x40mm 	1 st

Artikelnummer	Referensbild	Antal
5	M6 MUTTER 	X16
6	M6xBRICKA 	X16
7	T-nyckel 	1 st
8	RYCKA 	1 st

STEG 1

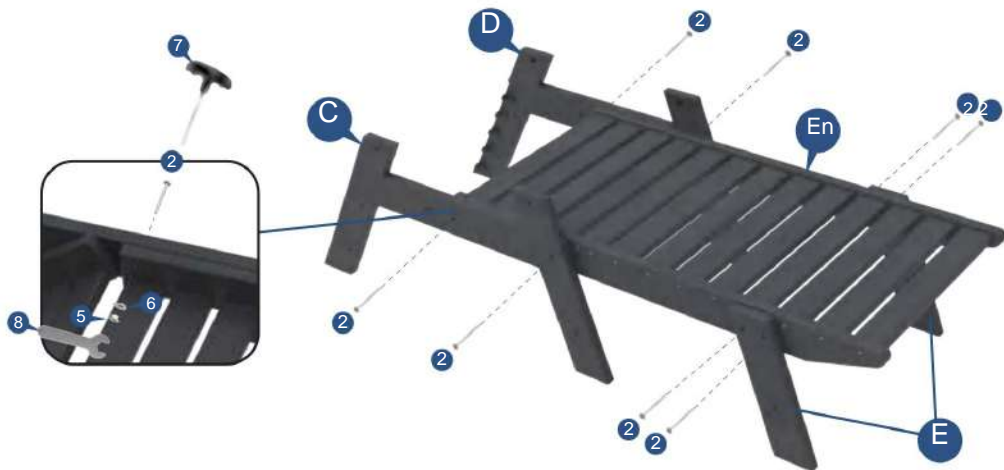

STEG 2

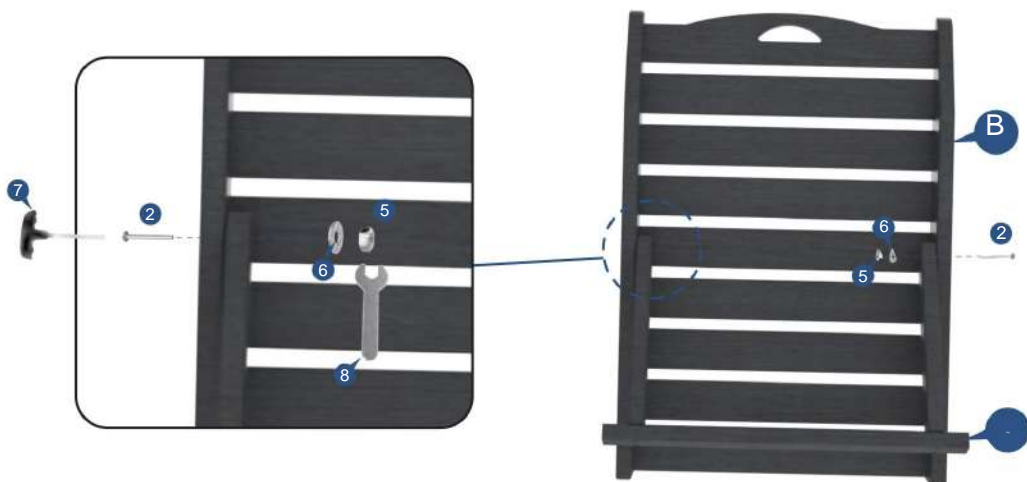

*Upprepa samma operation på andra sidan av stolen.

STEG 3

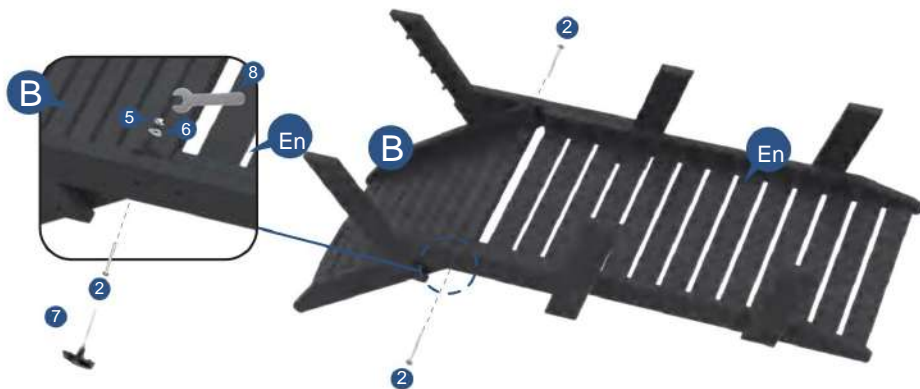

*Upprepa samma operation på andra sidan av stolen.

STEG 4



*Upprepa samma operation på andra sidan av stolen.

STEG 5

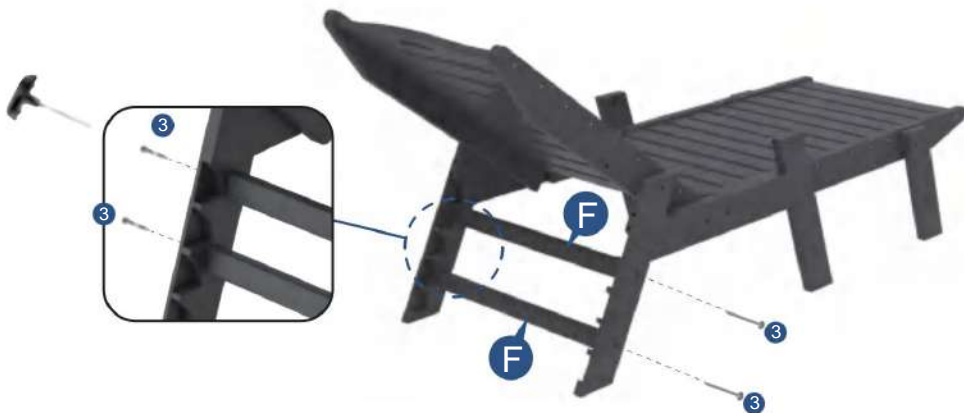

*Upprepa samma operation på andra sidan av stolen.

STEG 6



*Upprepa samma operation på andra sidan av stolen.



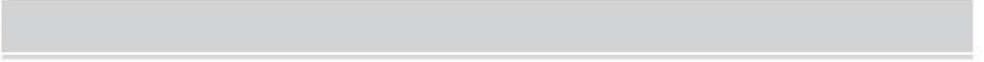



VEVOR[®]
TOUGH TOOLS, HALF PRICE

VEVOR[®]
TOUGH TOOLS, HALF PRICE

RS

VEVOR[®]
TOUGH TOOLS, HALF PRICE

PLÁSTICO

S

-4/5/6

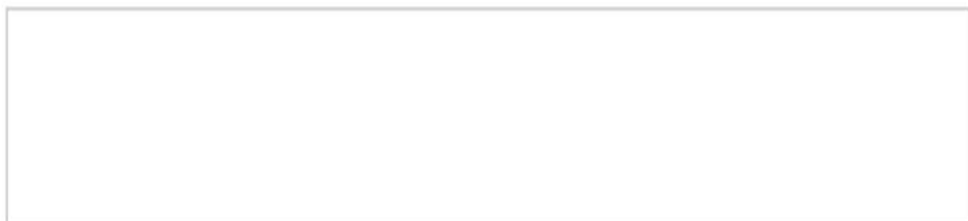





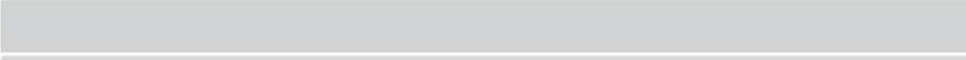

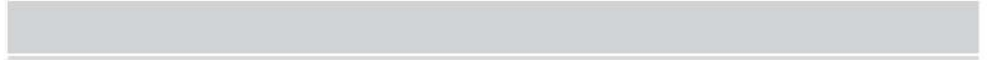



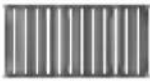

A long, empty rectangular text input field with a thin black border, positioned to the right of the image placeholder.









	$-\frac{4}{5/6}$		

N.º de artículo	Imagen de referencia	Cantidad
A	 ASIENTO	X 1
B	 RESPALDO	X 1
do	 PIERNA TRASERA IZQUIERDA	X 1
D	 PIERNA TRASERA DERECHA	X 1
mi	 PIERNA DELANTERA	X 2

N.º de artículo	Imagen de referencia	Cantidad
F	 CARRIL	X 4
GRABO	 BRAZO DERECHO	X 1
H	 BRAZO IZQUIERDO	X 1
I	 MARCO DE SOPORTE	X 1
Yo	 FONDO DE COPA	X 1



N.º de artículo	Imagen de referencia	Cantidad
1	M6x55 mm 	X 4
2	M6x60 mm 	X 12
3	M6x50 mm 	X 8
4	M6x40 mm 	X 1

N.º de artículo	Imagen de referencia	Cantidad
5	Tuerca M6 	X 16
6	M6×ARANDELA 	X 16
7	LLAVE EN T 	X 1
8	LLAVE INGLESA 	X 1

PASO 1

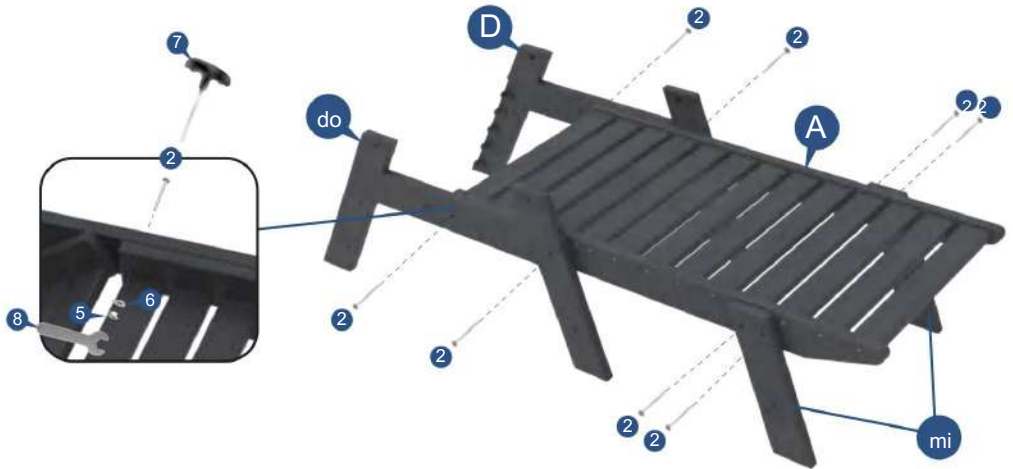

PASO 2

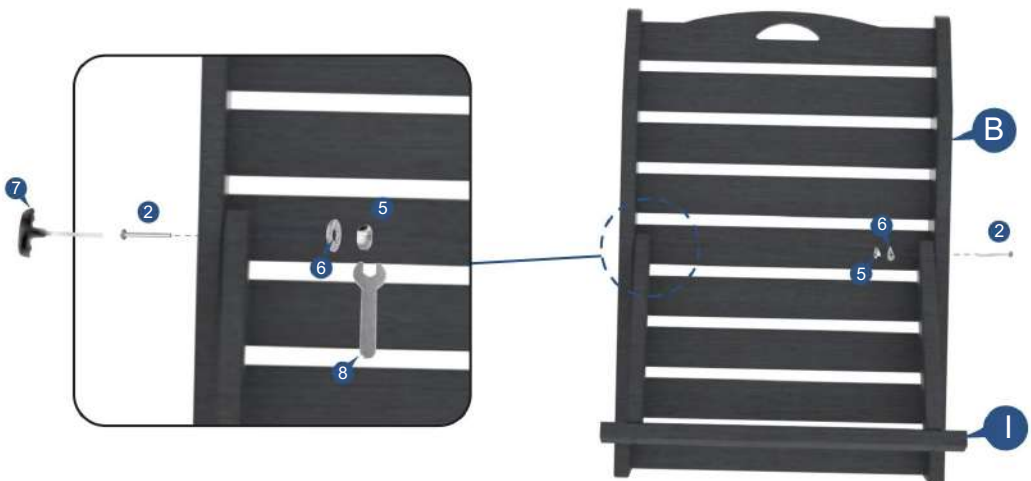

*Repita la misma operación en el otro lado de la silla.

PASO 3

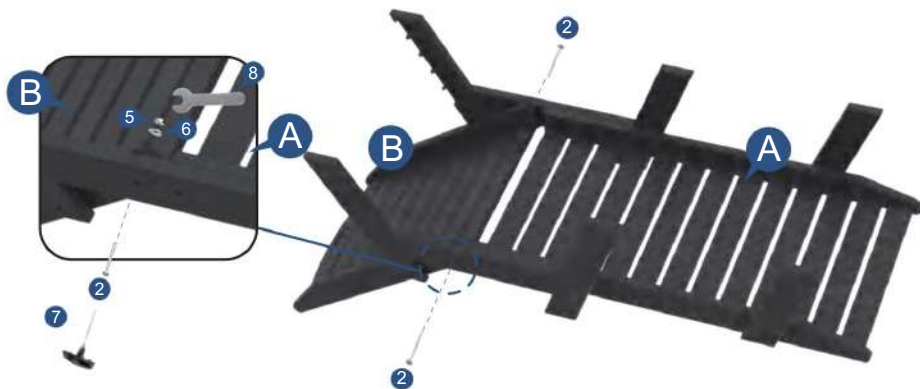

*Repita la misma operación en el otro lado de la silla.

PASO 4

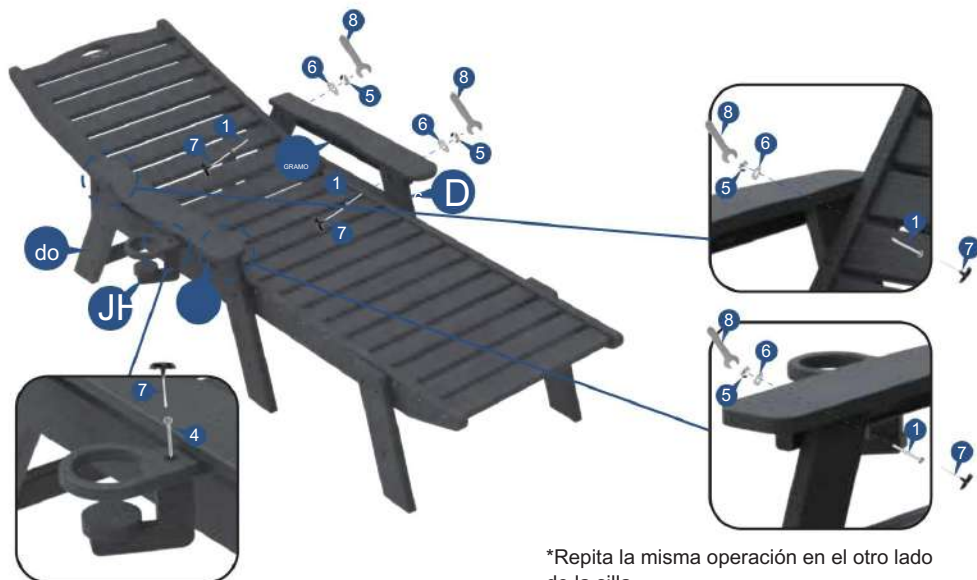

*Repita la misma operación en el otro lado de la silla.

PASO 5

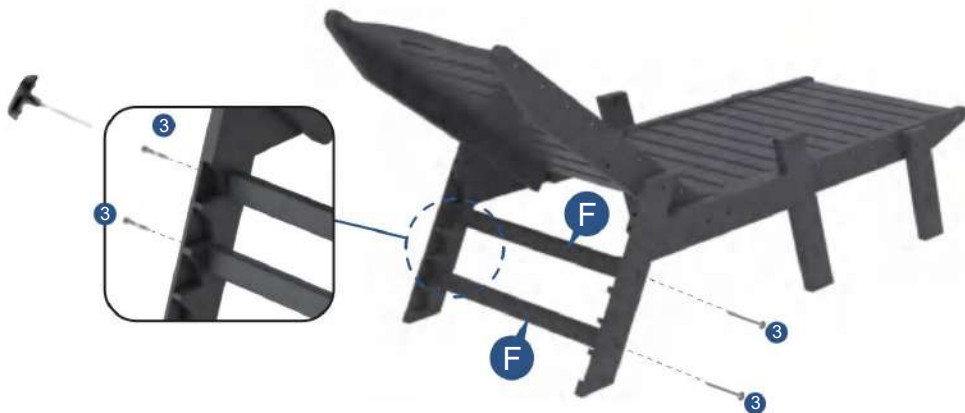

*Repita la misma operación en el otro lado de la silla.

PASO 6



*Repita la misma operación en el otro lado de la silla.



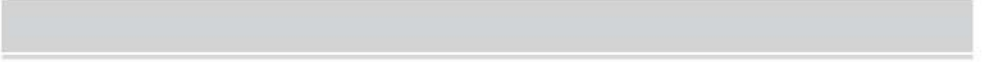



VEVOR®
TOUGH TOOLS, HALF PRICE

VEVOR[®]
TOUGH TOOLS, HALF PRICE

RS

VEVOR[®]

TOUGH TOOLS, HALF PRICE

PLASTICA

S

-4/5/6

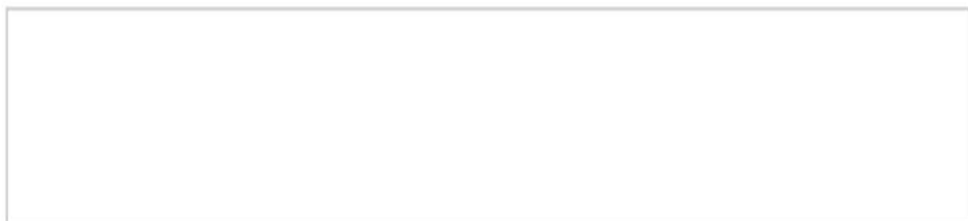





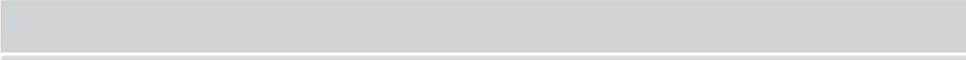







A large, empty rectangular box with a thin black border, occupying the top right portion of the page. It is currently blank.













	$-\frac{4}{5/6}$		

Articolo n.	Immagine di riferimento	Quantità
UN	 POTICO A LEGGERE	X 1
B	 SCHIENALE	X 1
C	 GAMBA POSTERIORE SINISTRA	X 1
D	 GAMBA DESTRA POSTERIORE	X 1
E	 ZAMPA ANTERIORE	X 2

Articolo n.	Immagine di riferimento	Quantità
F	 SBARRA	X 4
G	 BRACCIO DESTRO	X 1
H	 BRACCIO SINISTRO	X 1
	 TELAIO DI SUPPORTO	X 1
J	 FONDO DELLA TAZZA	X 1



Articolo n.	Immagine di riferimento	Quantità
1	M6x55mm 	X 4
2	M6x60mm 	X 12
3	M6x50mm 	X 8
4	M6x40mm 	X 1

Articolo n.	Immagine di riferimento	Quantità
5	DADO M6 	X 16
6	M6xRONDELLA 	X 16
7	CHIAVE A T 	X 1
8	CHIAVE 	X 1

PASSO 1

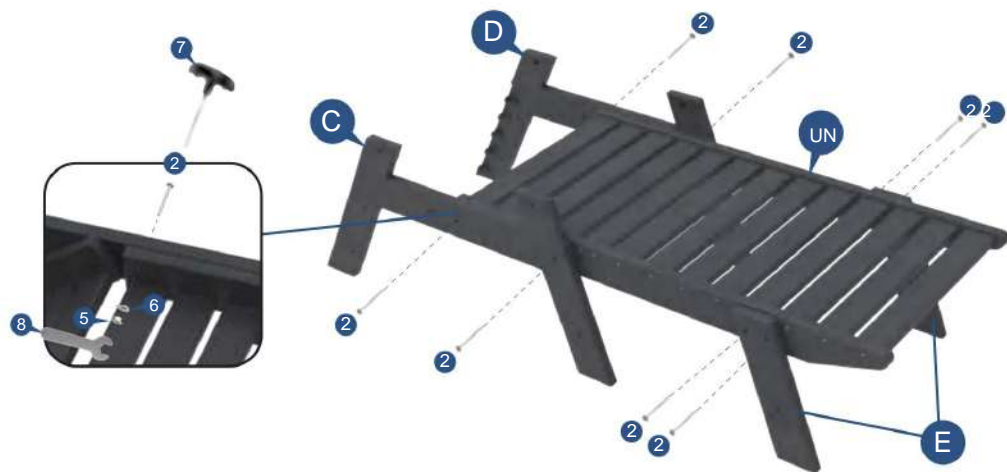

PASSO 2

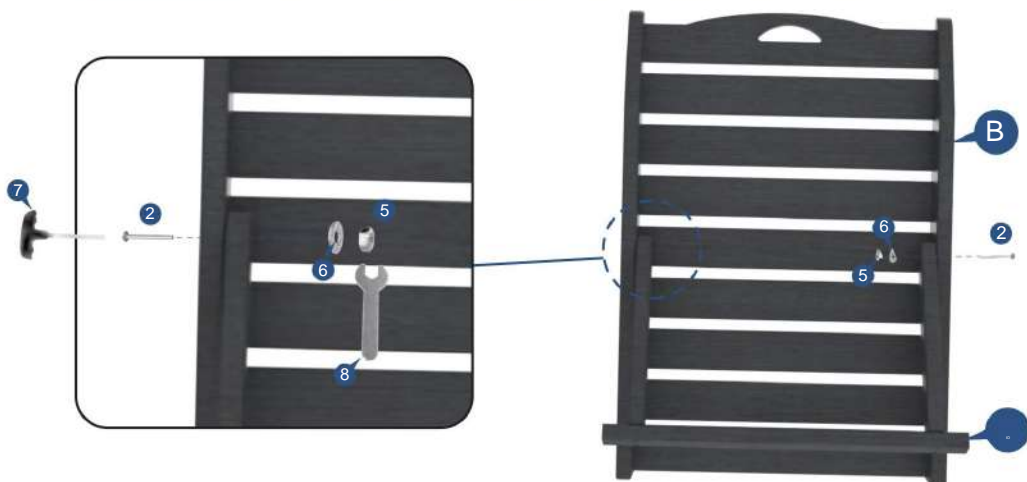

*Ripetere la stessa operazione sull'altro lato della sedia.

PASSO 3

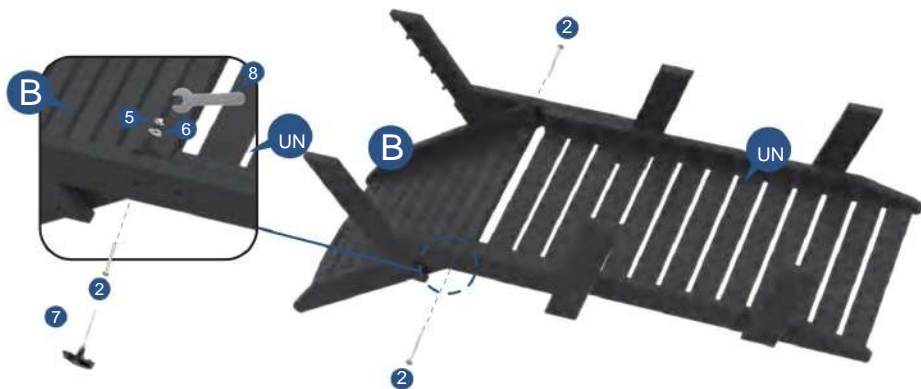

*Ripetere la stessa operazione sull'altro lato della sedia.

PASSO 4

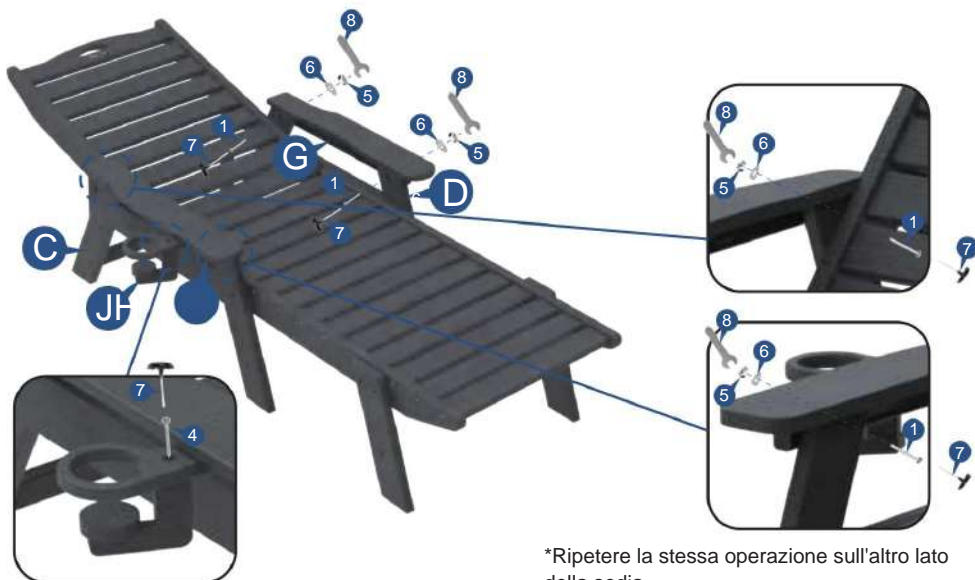

*Ripetere la stessa operazione sull'altro lato della sedia.

PASSO 5

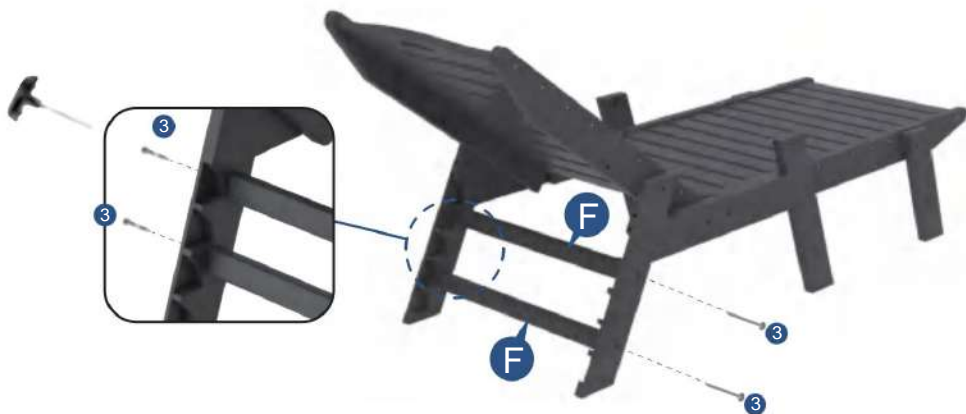

*Ripetere la stessa operazione sull'altro lato della sedia.

PASSO 6



*Ripetere la stessa operazione sull'altro lato della sedia.



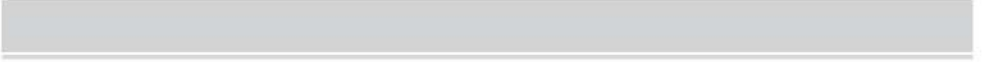



VEVOR®
TOUGH TOOLS, HALF PRICE

VEVOR[®]

TOUGH TOOLS, HALF PRICE

RS

VEVOR[®]
TOUGH TOOLS, HALF PRICE

PLASTIKOWY

S





-4/5/6















	$-4/5/6$		

Pozycja nr.	Obraz referencyjny	Ilość
A	 SIEDZIBA	X1
B	 OPARCIE	X1
C	 TYŁ LEWA NOGA	X1
D	 TYŁ PRAWA NOGA	X1
mi	 PRZEDNIA NOGA	2x

Numer pozycji	Obraz referencyjny	Ilość
F	 KOLEJ	X4
G	 PRAWIE RAMIĘ	X1
H	 LEWIE RAMIĘ	X1
I	 RAMA SPORTOWA	X1
J	 DNO KUBKA	X1



Numer pozycji	Obraz referencyjny	Ilość
1	M6x55mm 	X4
2	M6x60mm 	X12
3	M6x50mm 	X8
4	M6x40mm 	X1

Pozycja nr.	Obraz referencyjny	Ilość
5	Nakrętka M6 	X16
6	Podkładka M6x 	X16
7	KLUCZ T 	X1
8	KLUCZ 	X1

KROK 1

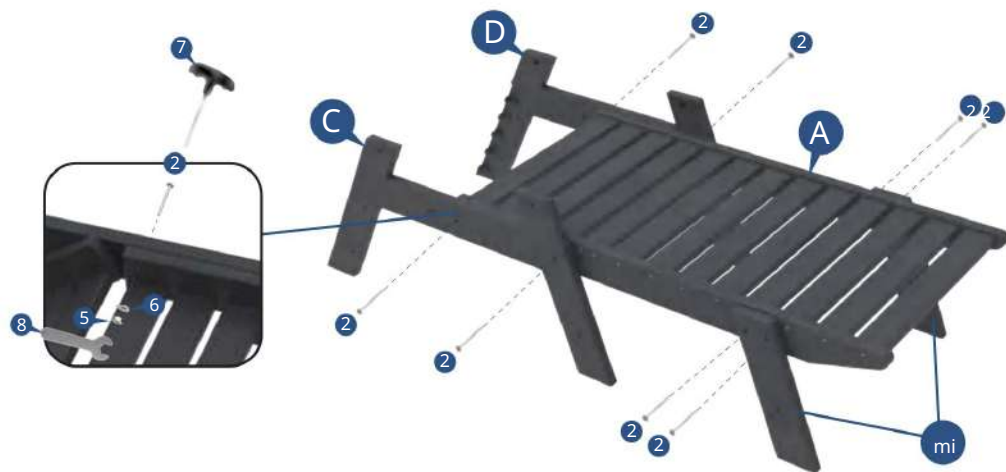

KROK 2

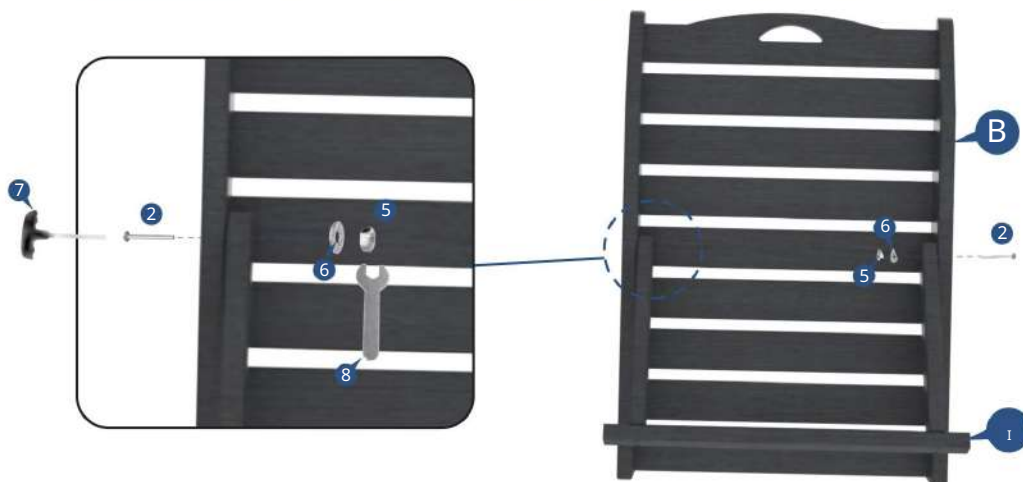

*Powtórz tę samą czynność po drugiej stronie krzesła.

KROK 3

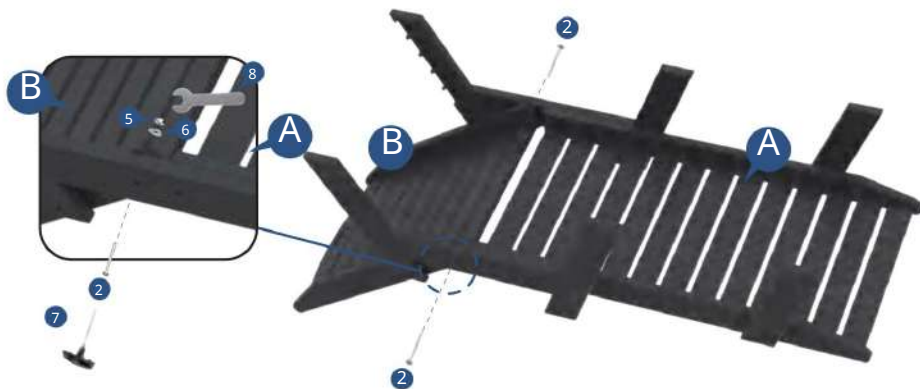

*Powtórz tę samą czynność po drugiej stronie krzesła.

KROK 4

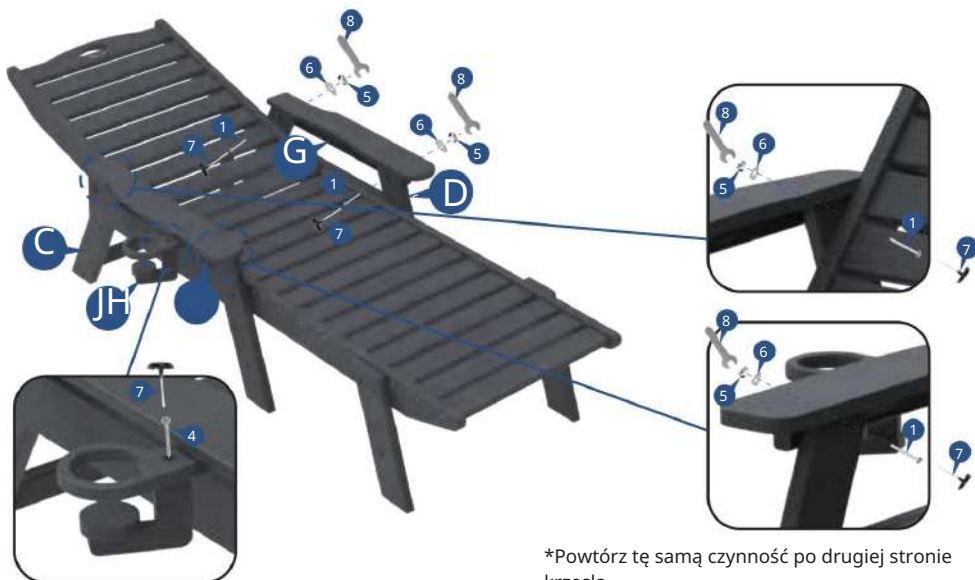

*Powtórz tę samą czynność po drugiej stronie krzesła.

KROK 5

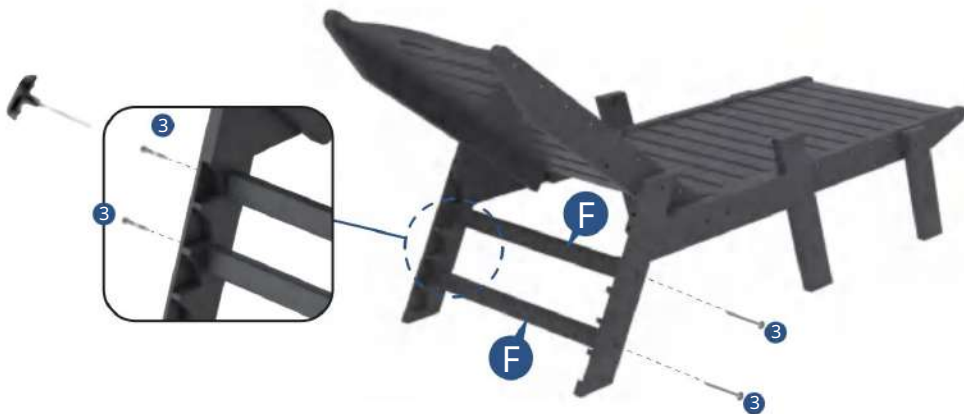

*Powtórz tę samą czynność po drugiej stronie krzesła.

KROK 6



*Powtórz tę samą czynność po drugiej stronie krzesła.



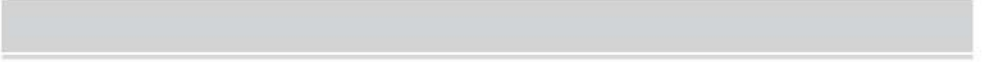



VEVOR[®]
TOUGH TOOLS, HALF PRICE