

ASSEMBLY INSTRUCTION

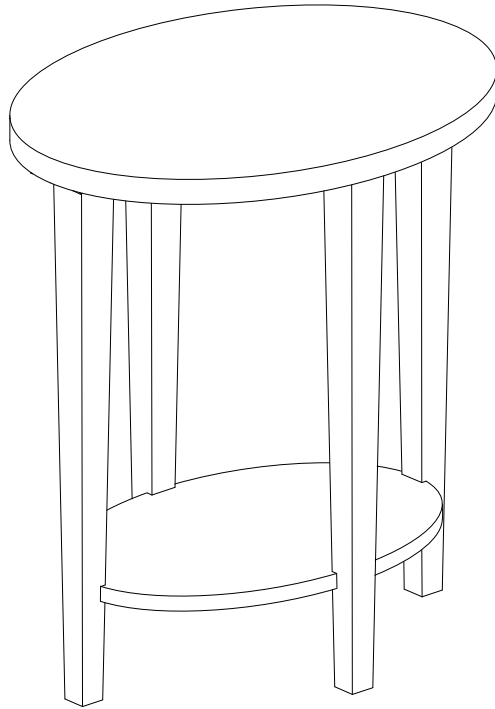

① x1pc

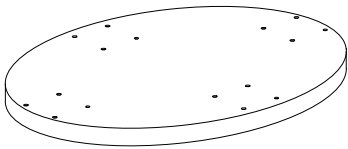

② x1pc

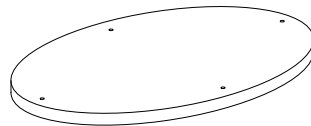

③ x4pcs

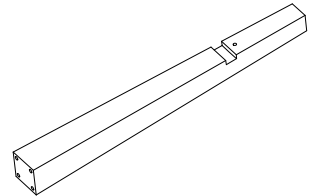

Ⓐ x4pcs

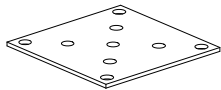

Ⓑ x16pcs



5x40

Ⓒ x24+1pcs

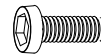

M6x12

Ⓓ x4pcs

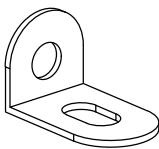

Ⓔ

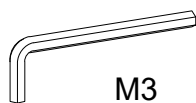

M3



M4

ASSEMBLY INSTRUCTION

STEP 1

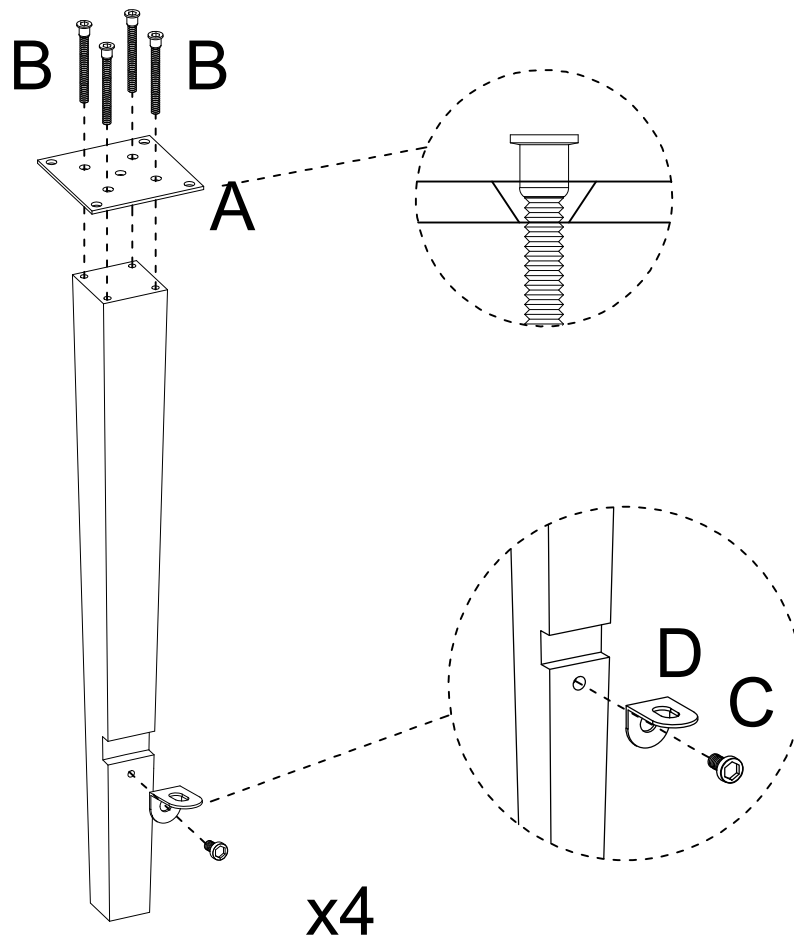

STEP 2

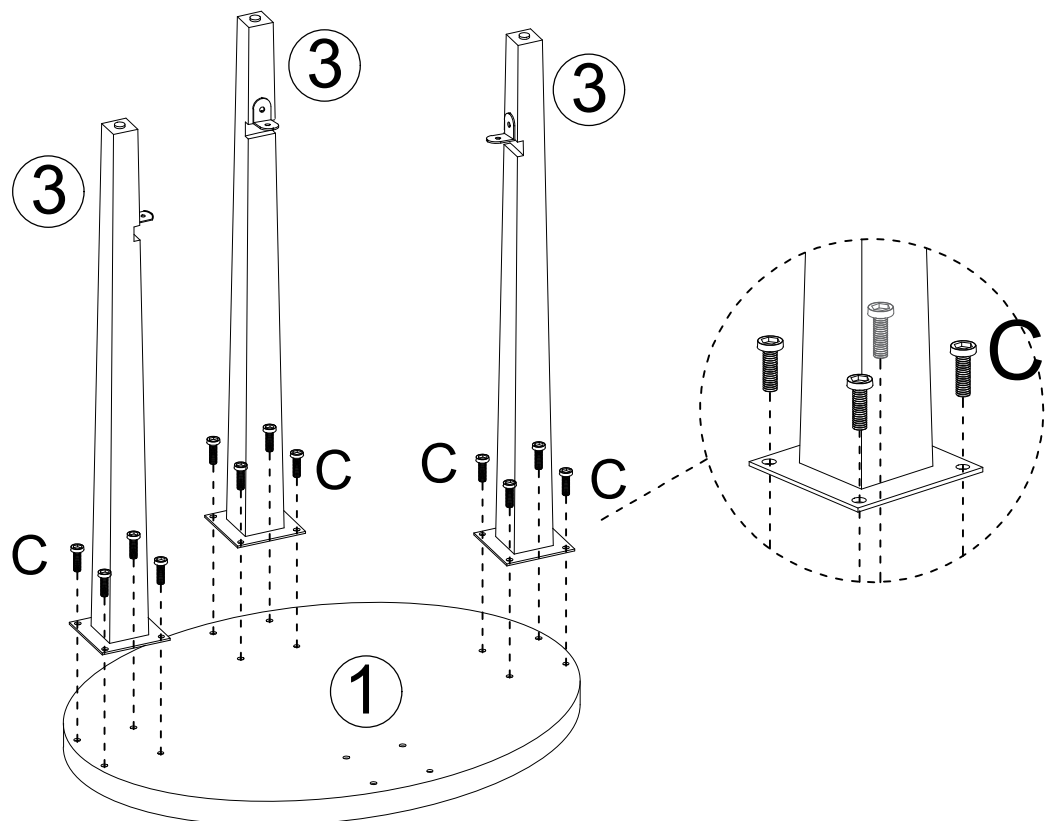

ASSEMBLY INSTRUCTION

STEP 3

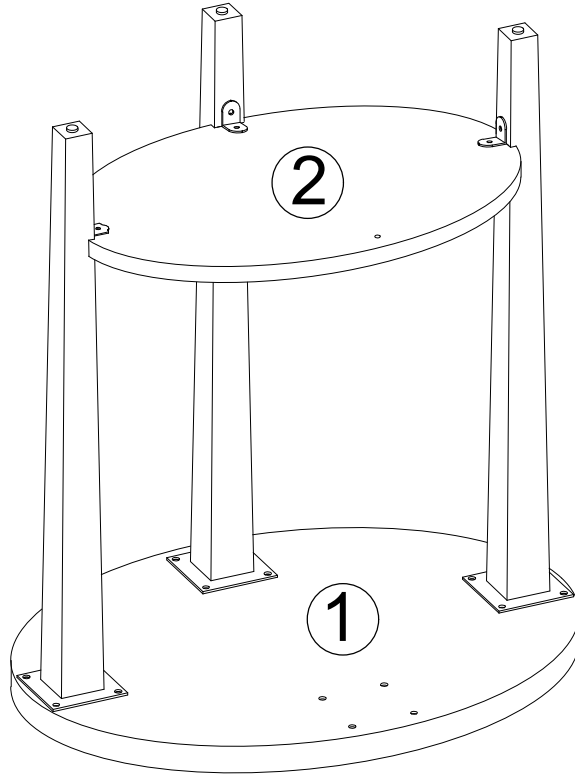

STEP 4

