

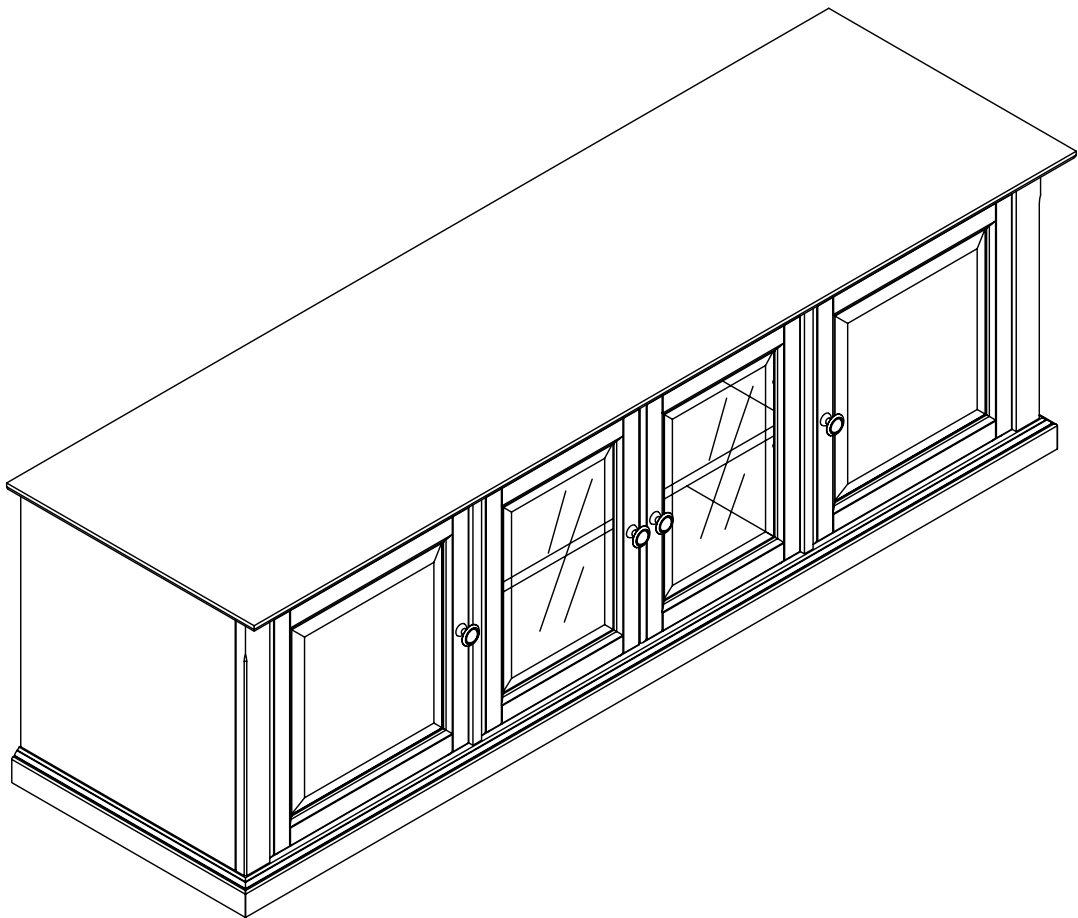

60" Low Profile TV Stand Cabinet

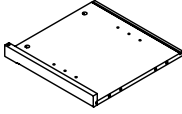

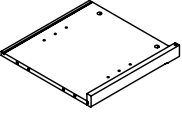

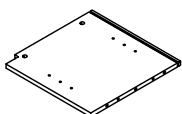
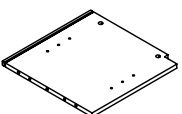
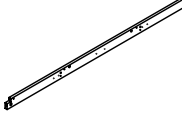
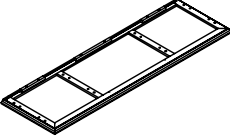
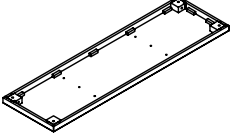
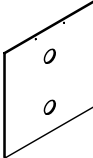
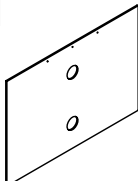
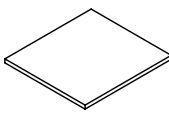
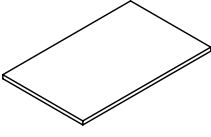

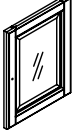
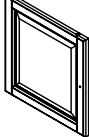
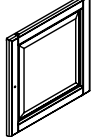
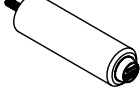
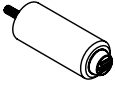



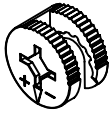
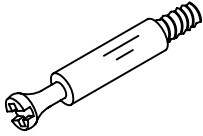
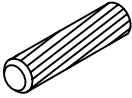

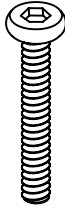
Care: Use a soft clean cloth that will not scratch the surface when dusting. Use of furniture polish is not necessary. Should you choose to use polishes, test in an inconspicuous area first. Use of solvents of any kind may damage your furniture's finish. To clean, simply use a soft clean cloth moistened with lukewarm water, then buff with a dry soft clean cloth.

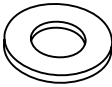
PART LIST

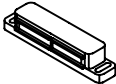
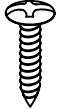
<p>A</p> 	<p>B</p> 	<p>C</p> 	<p>D</p> 	<p>E</p> 
<p>1 PC</p>	<p>1 PC</p>	<p>1 PC</p>	<p>1 PC</p>	<p>1 PC</p>
<p>F</p> 	<p>G</p> 	<p>H</p> 	<p>I</p> 	<p>J</p> 
<p>1 PC</p>	<p>1 PC</p>	<p>2 PCS</p>	<p>1 PC</p>	<p>2 PCS</p>
<p>K</p> 	<p>L</p> 	<p>M</p> 	<p>N</p> 	<p>O</p> 
<p>1 PC</p>	<p>1 PC</p>	<p>1 PC</p>	<p>1 PC</p>	<p>1 PC</p>
<p>P</p> 	<p>Q</p>  <p>For use only with Bun Foot</p>			
<p>2 PCS</p>	<p>2 PCS</p>			

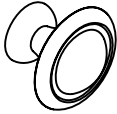
HARDWARE LIST

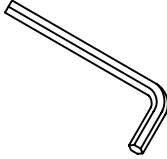
1		2		3		4		5	
CAM LOCK 10 PCS		CAM BOLT 10 PCS		WOOD DOWEL 20 PCS		SCREW 4 PCS		ALLEN BOLT 8 PCS	
6		7		8		9		10	
SPRING WASHER 8 PCS		FLAT WASHER 8 PCS		DOOR MAGNET 2 PCS		DOUBLE DOOR MAGNET 1 PC		ROUND HEAD SCREW 13 PCS	
11		12		13		14			
SHELF HOLDER 12 PCS		KNOB 4 PCS		ROUND HEAD BOLT 4 PCS		ALLEN WRENCH 1 PC			

Tools needed: Allen Wrench (part#14)(included)
Phillips Head Screw Driver (Not included)

Note: Wood dowels (Part#3) are intended for alignment only when assembling your furniture. Additional clearance between the wood dowels and pre-drilled hole is intentional for ease of assembly.

Step 1. Insert Cam Bolts(Part#2) into pre-drilled holes of Parts A, B & F using a Phillips Head screw driver as shown.

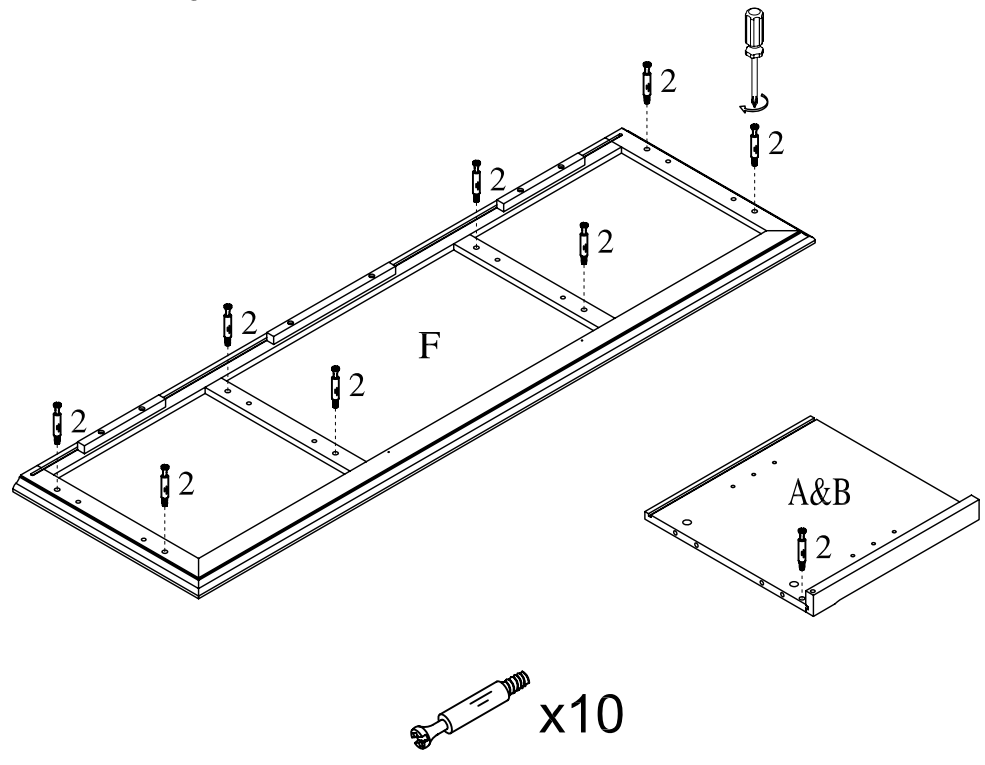

Step 2. Attach Rail E to the Panels C & D with wood dowels and Screws (Part#4) through pre-drilled holes as shown

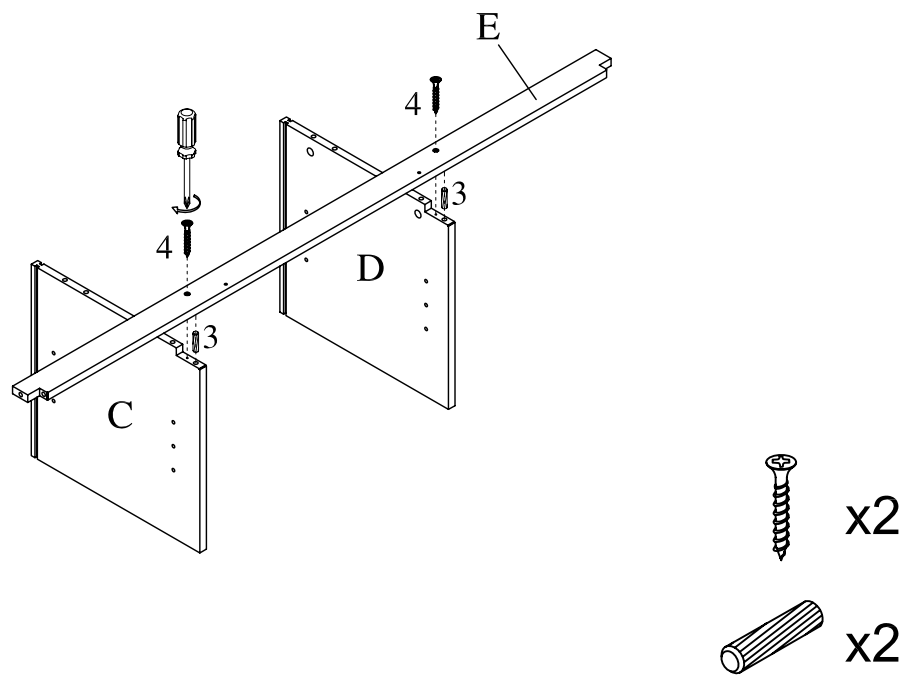

Step 3. Attach Side Panels A & B to Rail E with wood dowels and Cam locks as shown.

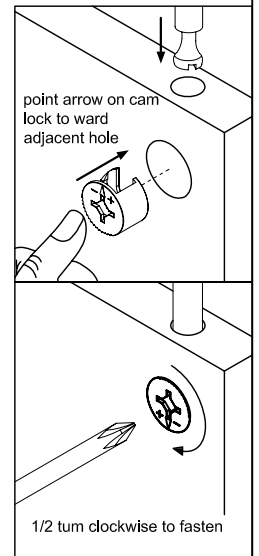
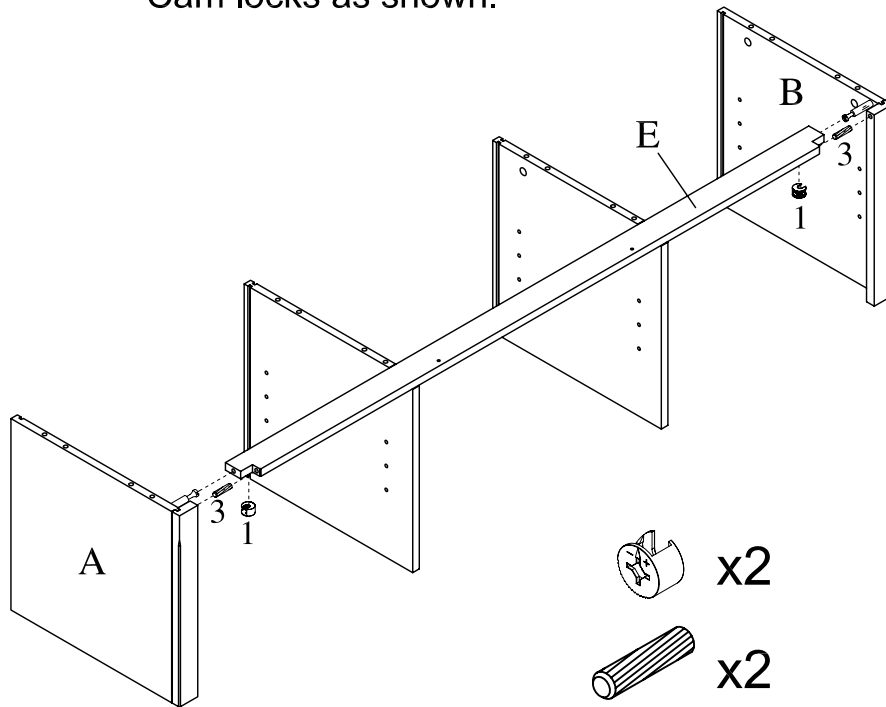

Step 4. Attach Top F to Part A, C, D & B using wood dowels and Cam locks as shown. Secure Rail E to Top F using Screws(Part#4) through pre-drilled holes as shown. Carefully turn cabinet over with top on the floor.

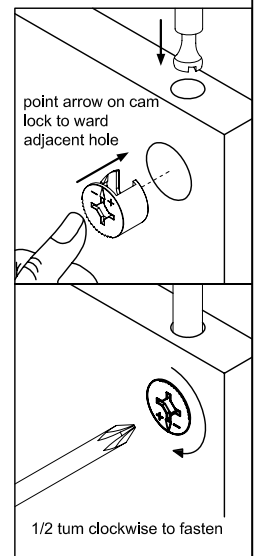
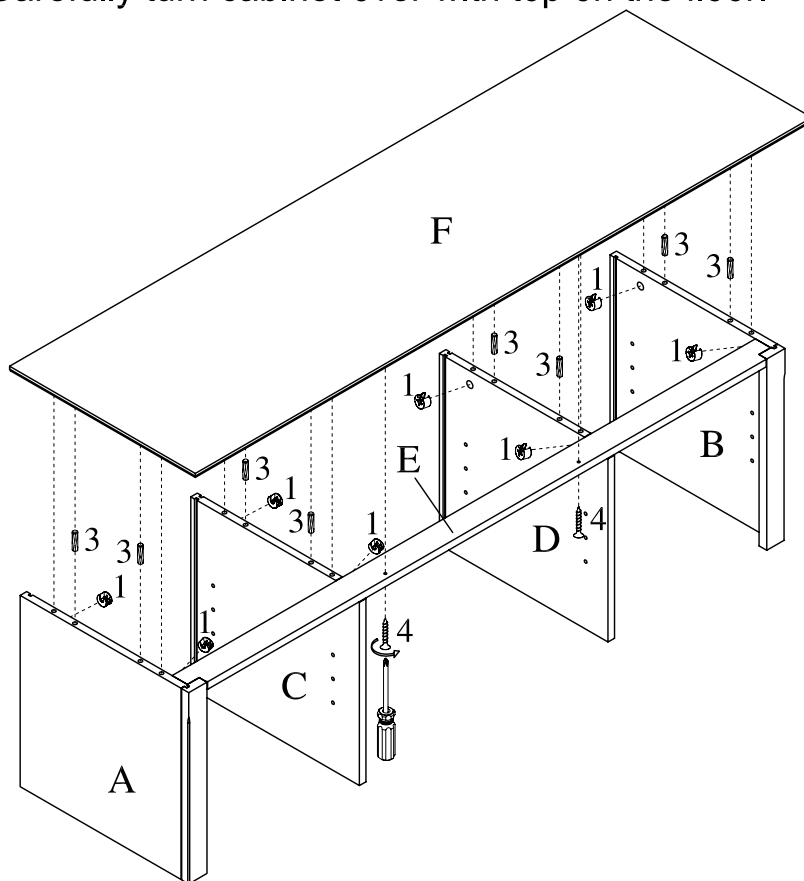

Step 5. Slide Back panels H & I into the grooves as shown.
 Note: Be sure back panels H & I are inserted completely into grooves in Top F before attaching base G in step 6.

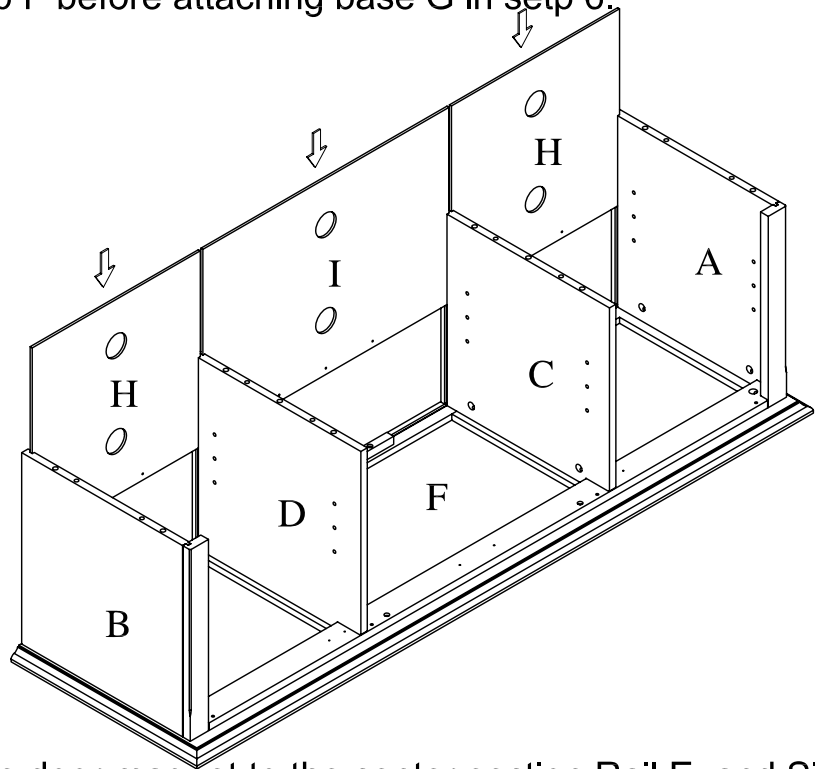

Step 6. Attach Double door magnet to the center section Rail E, and Single door magnet to both side section Rail E using Round Head Screws (Part#10) as shown. Attach Base G to cabinet using wood dowels and Allen Bolts with Spring / Flat Washer as shown. Attach legs using Hex Socket Head Bolts & Wood Dowels (as shown in instruction manual included in carton with legs).

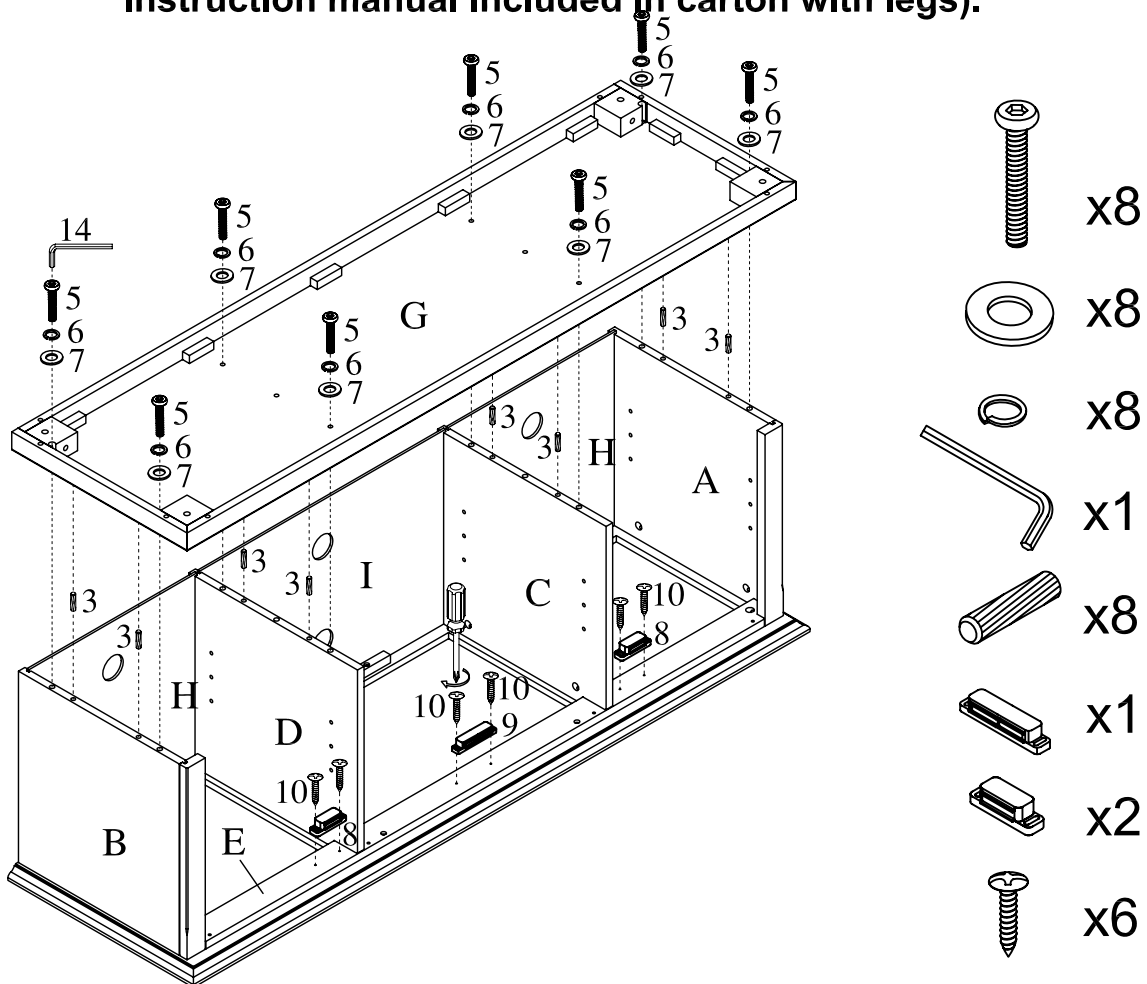

Step 7. Carefully turn cabinet over with top upward.
Screw the Round head screws (Part#10) into pre-drilled holes
of Back panels H & I as shown

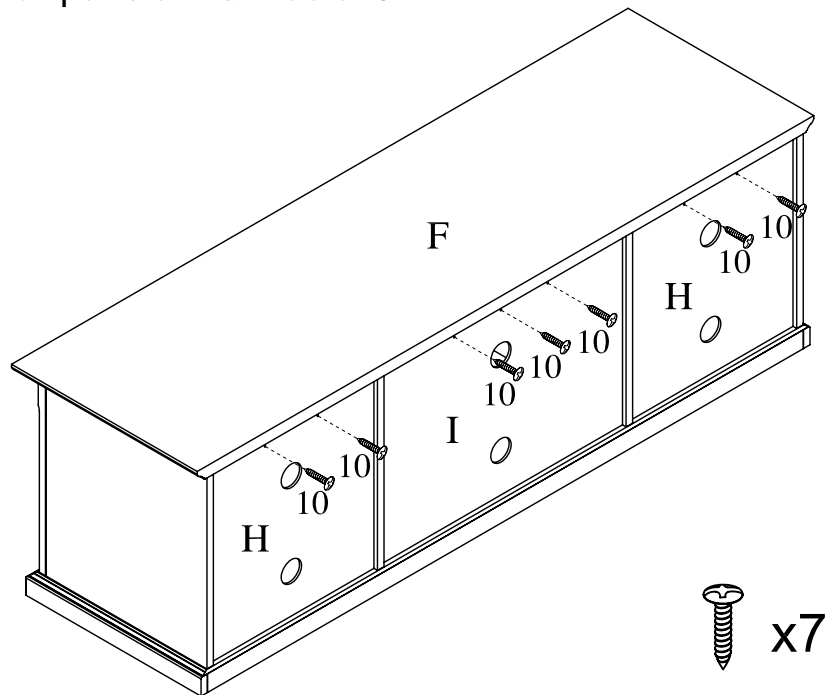

Step 8. Insert the Shelf Holders (Part#11) into desired position and
add shelves.

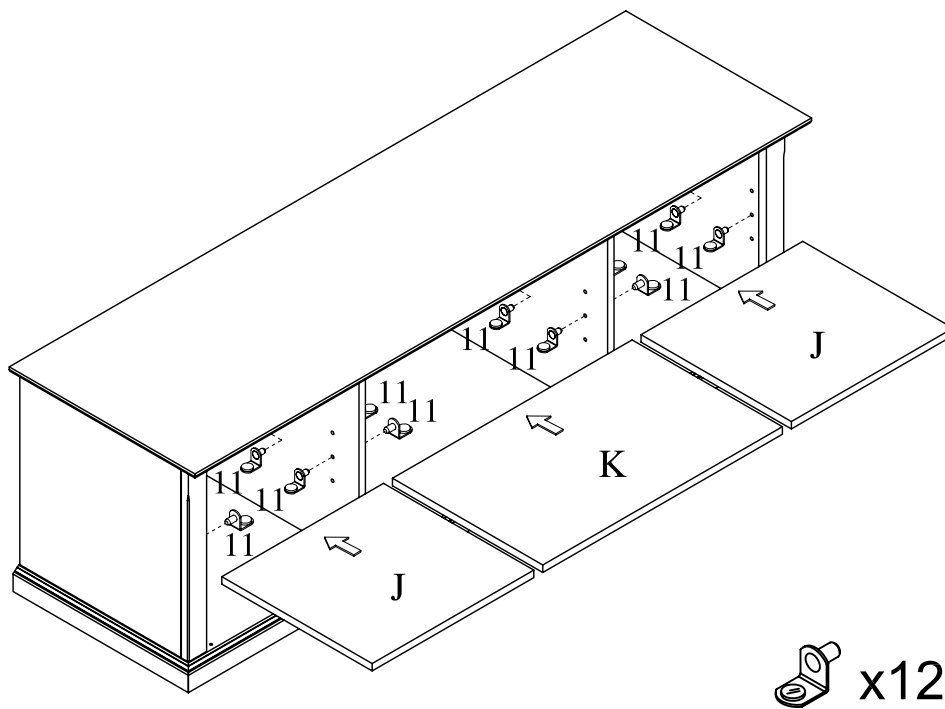

Step 9. Attach hardware Knobs (Part#12) to Doors L, M, N, O using Round head bolts (Part#13) as shown. Attach doors to cabinet by placing bottom Pin Hinge into pre-drilled holes at the bottom & depressing top spring loaded Pin Hinge to fit door into place. Note: Be sure Pin Hinges (top & bottom) have fully extended into the pre-drilled holes to secure doors into place.

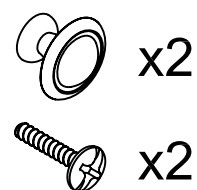
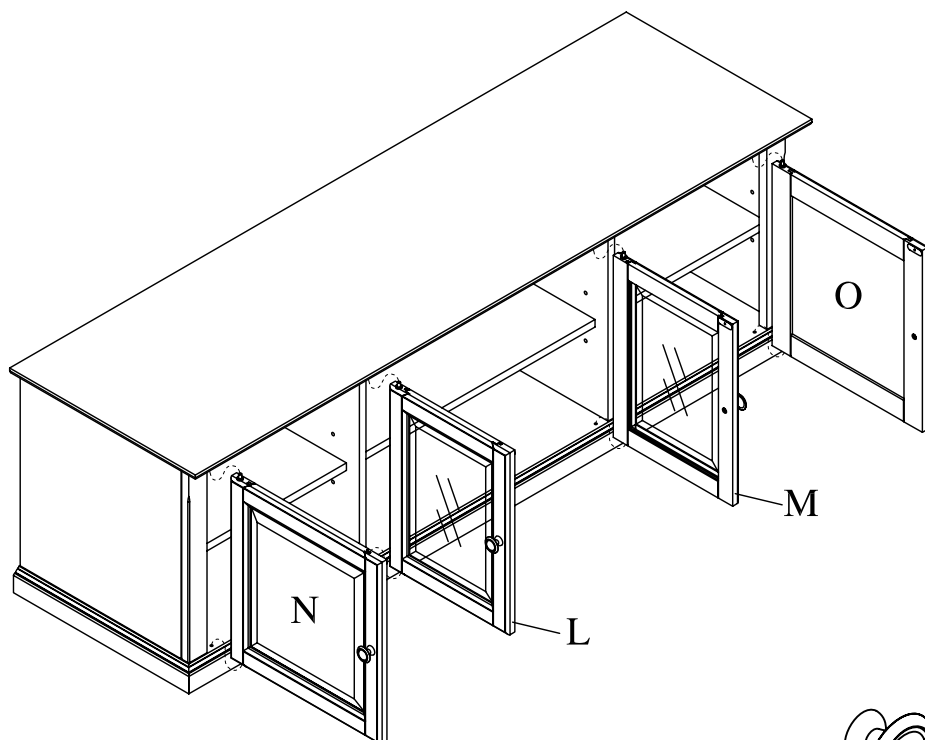
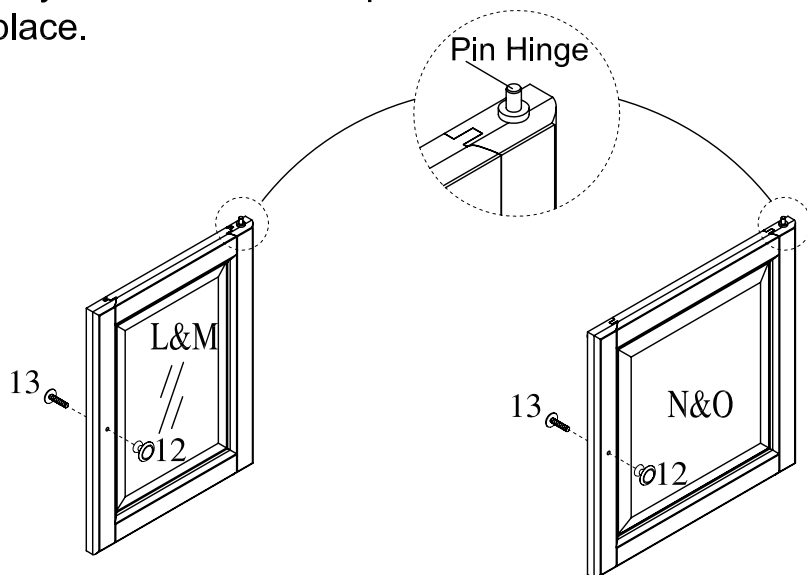

Step 10. Place your assembled cabinet into the desired spot in your home. Attach the Center Support Leg P or Q now by turning clockwise into the pre-drilled hole. Support Leg Q is for use only with Bun Foot. All other Leg styles will use support Leg P. NOTE: The adjustable leveler on the bottom of the Center Support Legs P/Q should not be extended until after installation. Adjust the leveler on the bottom of the Center Support leg P/S until it fits tightly against the floor. Use of the support leg is important to support the center of the cabinet.

IMPORTANT! - IF YOU WISH TO RELOCATE YOUR CABINET, BE SURE TO REMOVE THE CENTER SUPPORT LEGS. RE-INSTALL AFTER THE CABINET HAS BEEN MOVED.

