

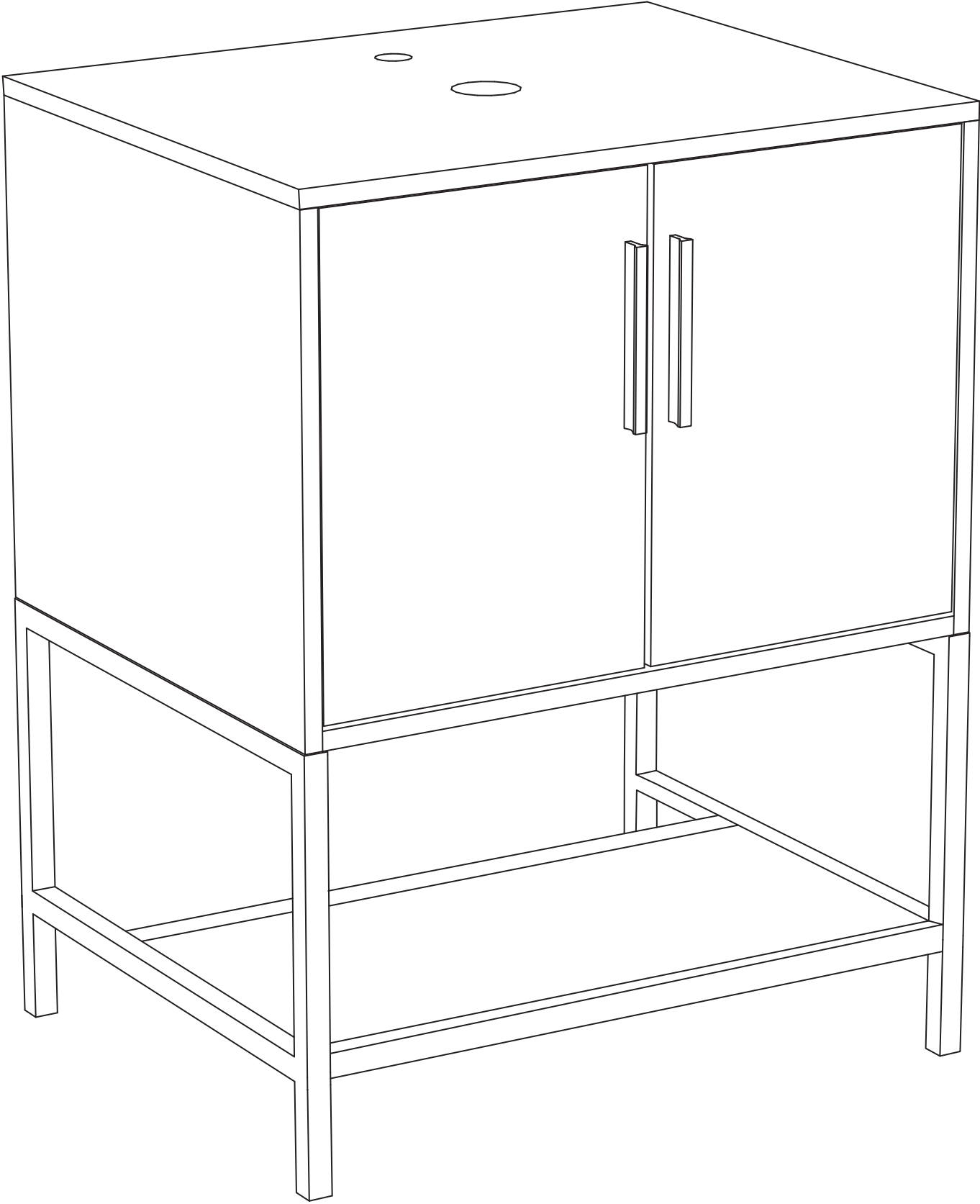









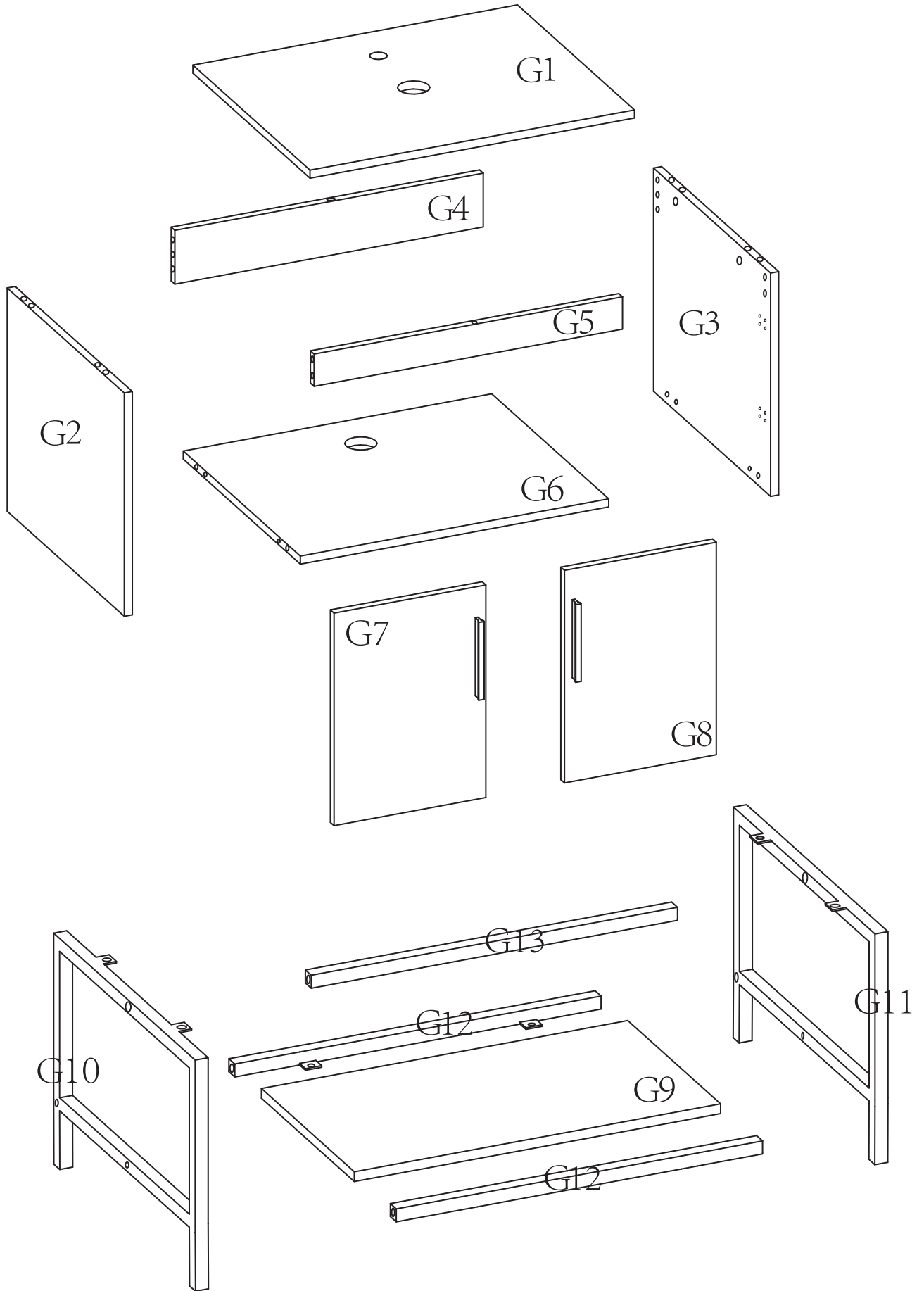

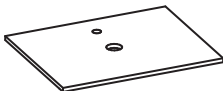
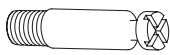

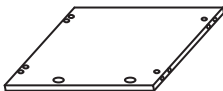

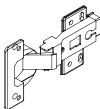
FEEDBACK ★★★★★

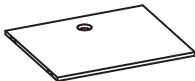

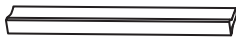
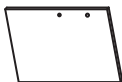
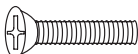
THKFBV016AK0YT

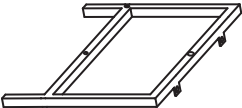
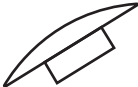
ASSEMBLY DIAGRAM



PARTS LIST			HARDWARE LIST		
NO.	DESCRIPTION	QTY	NO.	DESCRIPTION	QTY
G1		1	A		18
G2		1	B		18
G3		1	C		10
G4		1	D		4
G5		1	E	 HASCREW M6*30	6
G6		1	F	 SCREW M4*14	32
G7		1	G		2
G8		1	H		4
G9		1	I		1
G10		1	J		18
G11		1			
G12		2			
G13		1			

CAUTION: Please confirm the parts list before installtion

INSTALLATIONS

STEP 1

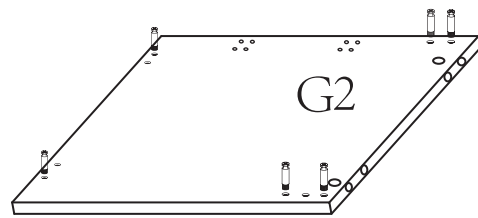
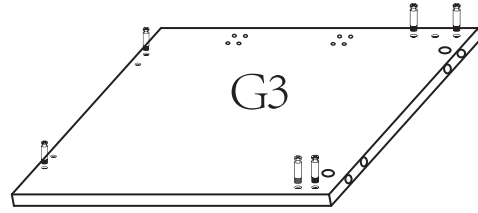
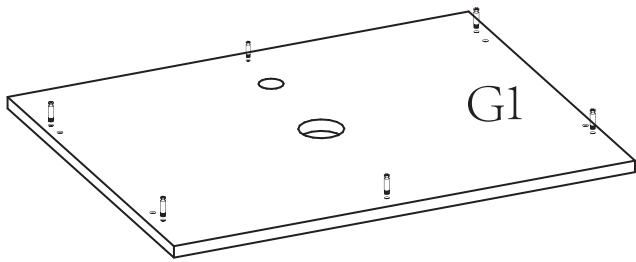
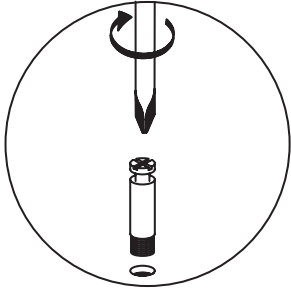

STEP 2

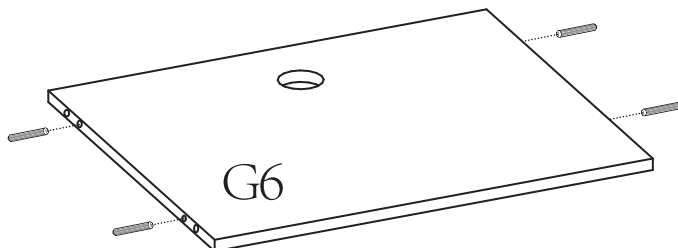
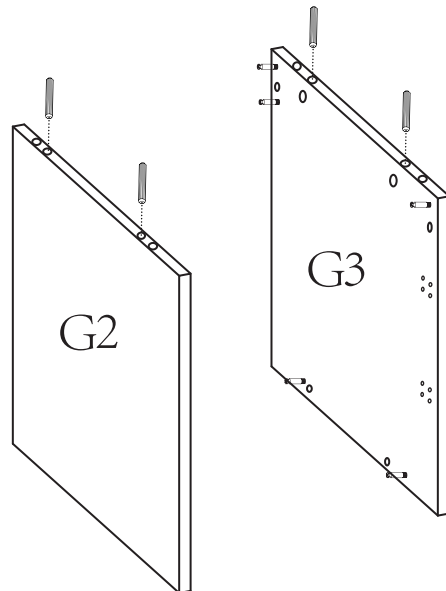
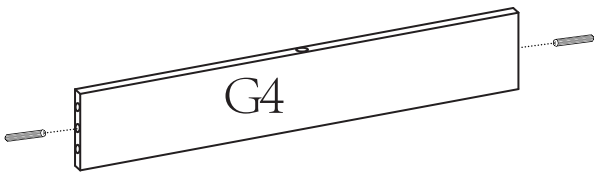

STEP3



BX6



JX6

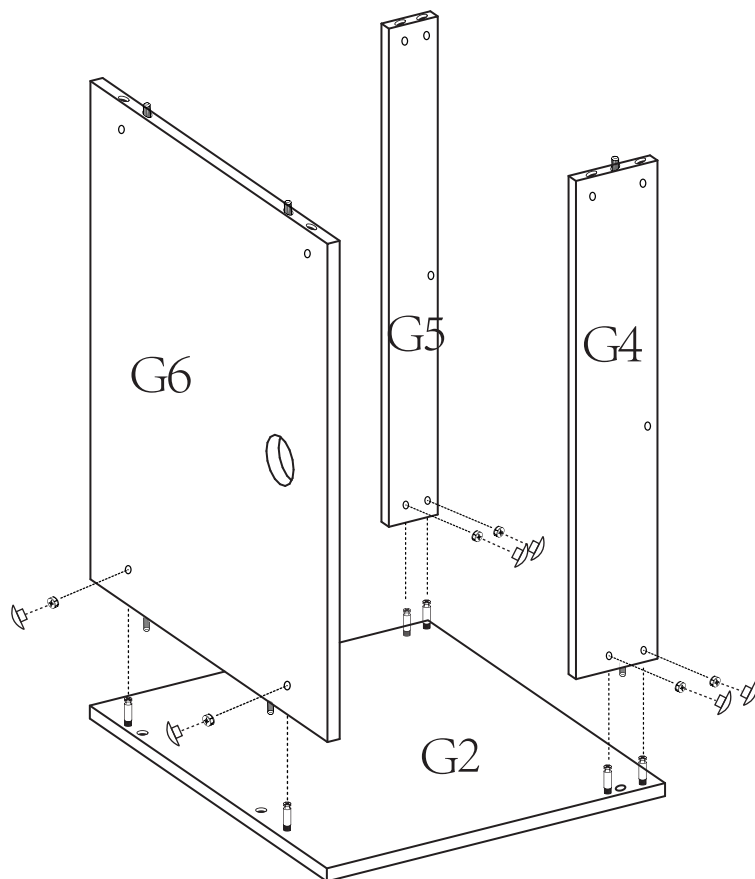

STEP4





BX6

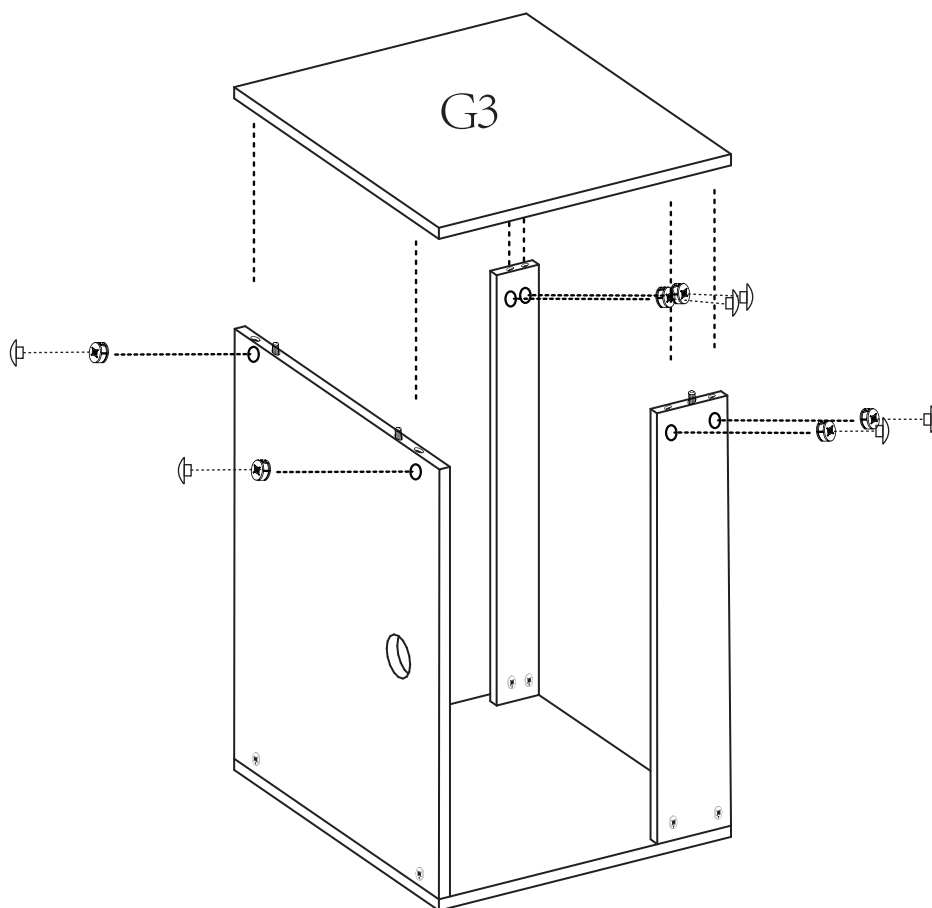

JX6





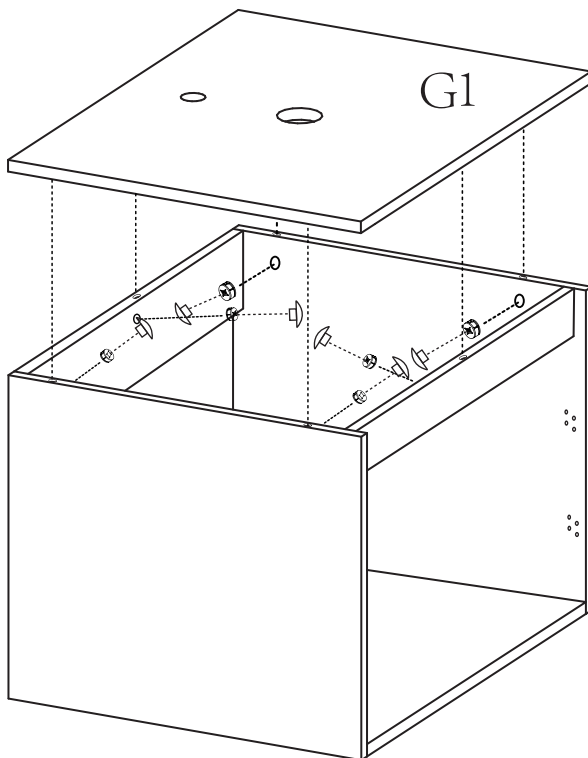

STEP5

-  BX6
-  JX6



STEP6

-  DX4
-  FX8
-  GX2
-  HX4

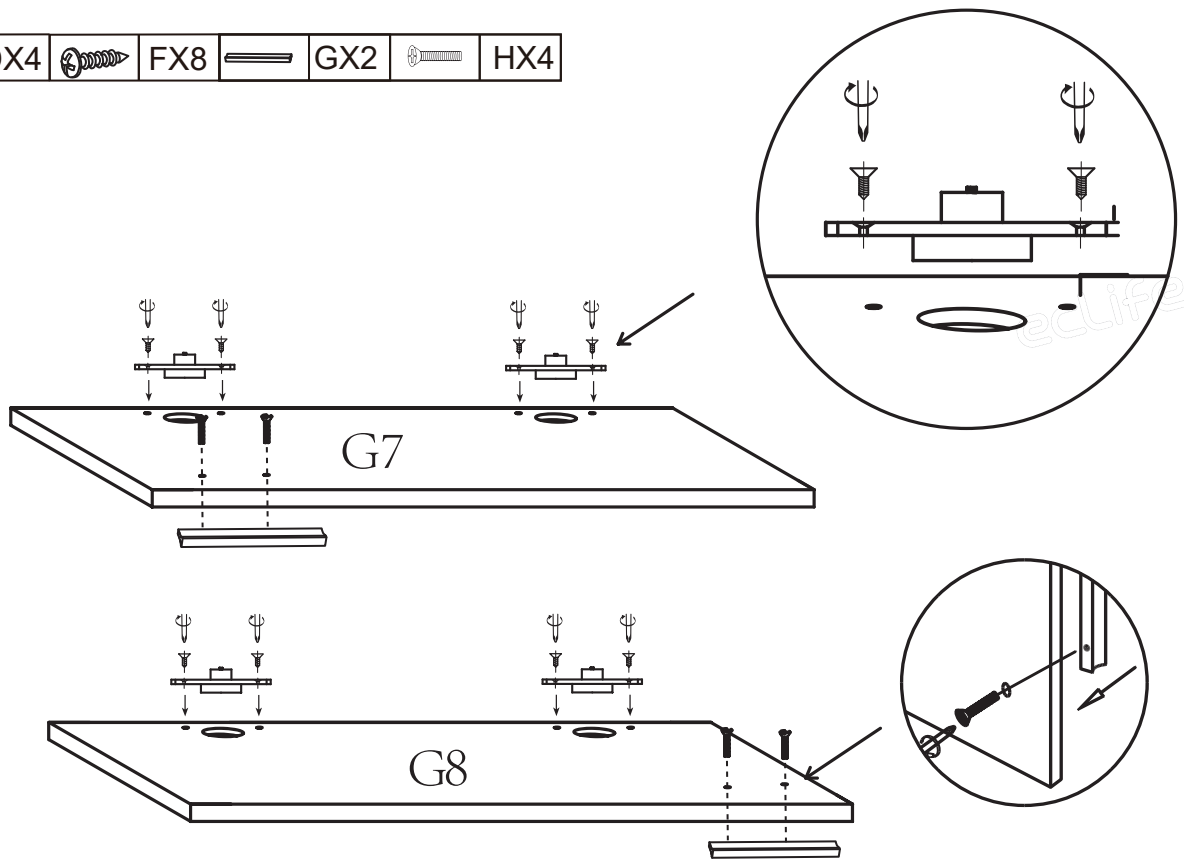

STEP7



FX16

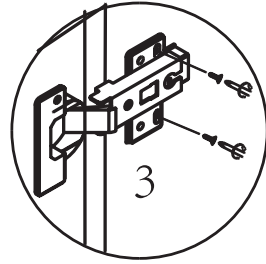
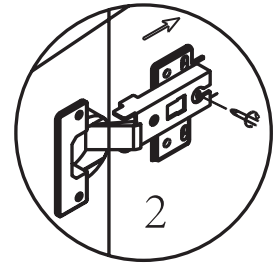
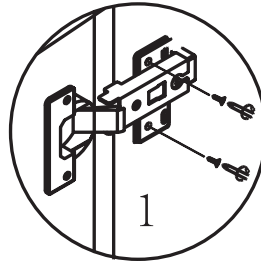
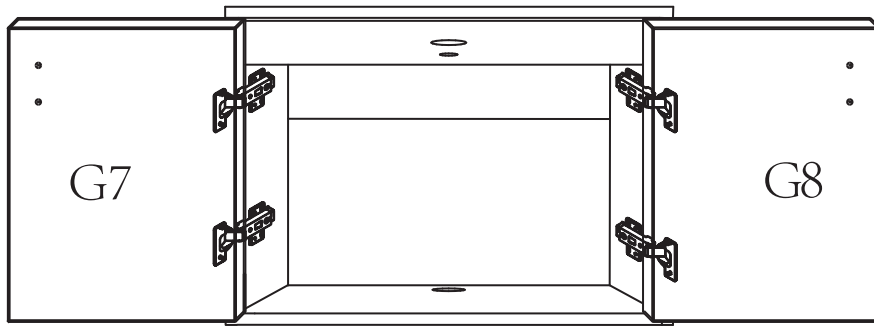

STEP8



EX6

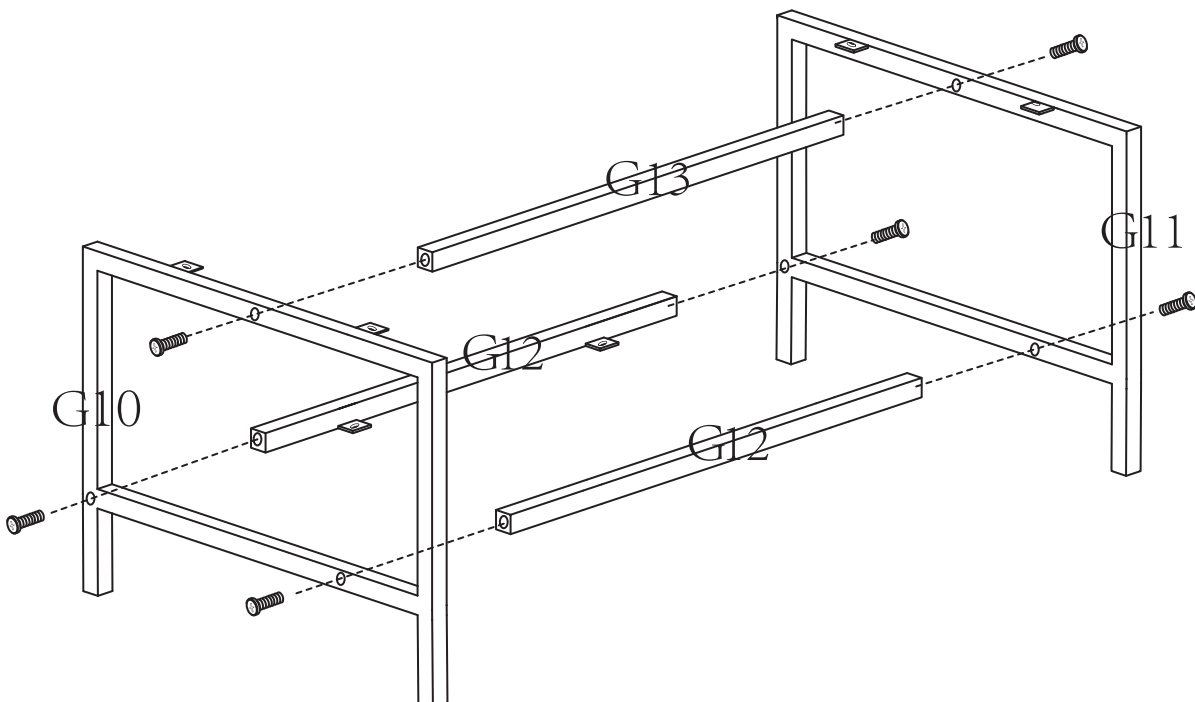

STEP9



FX8

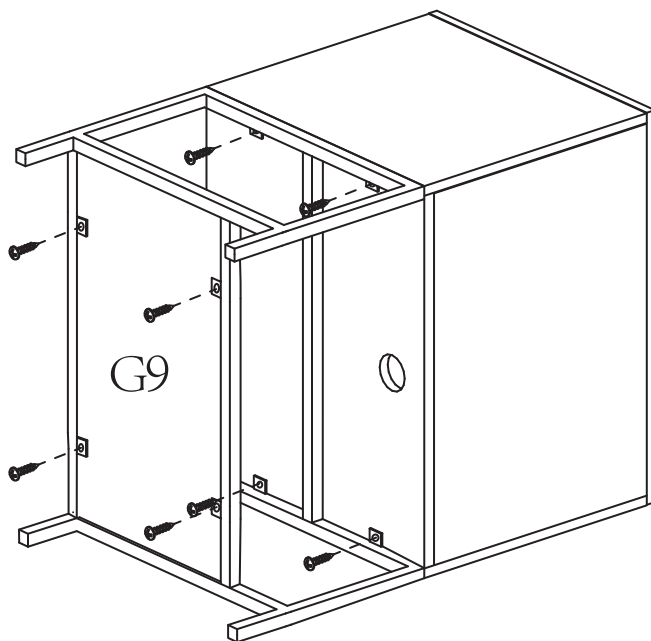

STEP10

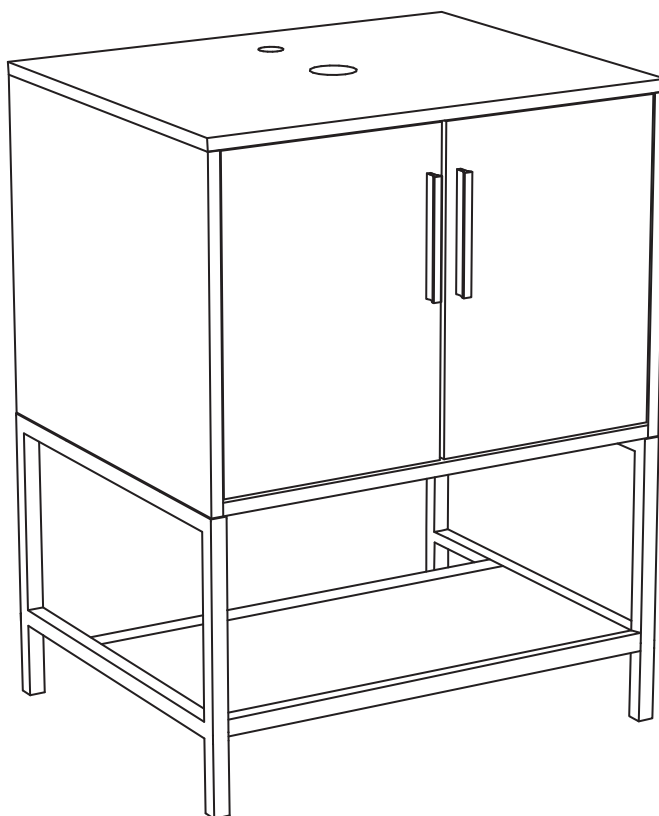

Thank you very much for purchasing from us.

We have always been trying to provide the best service and reliable products for every customer.

However, accident may happen sometimes, please contact us to resolve any issue before leaving a negative feedback.

Many thanks and welcome to our shop again!

Contact number: 626-3625309

E-mail: support@ec-export.com

www.ec-export.com

