

ASSEMBLY INSTRUCTION

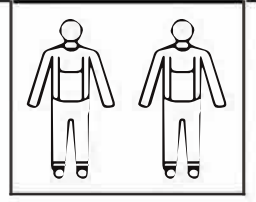

A*1

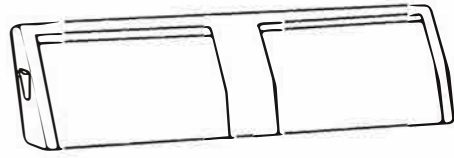

B*1

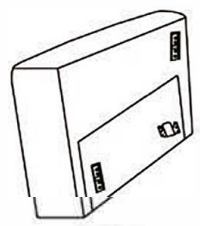

C*2



D*2

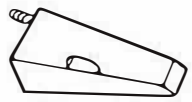

E*2

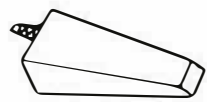

F*2



G*2



H*1



I*2



J*4

STEP 1

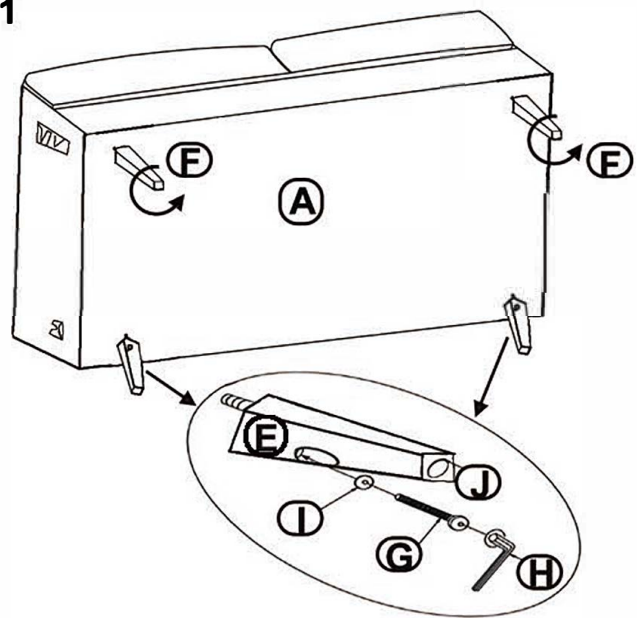

STEP 2

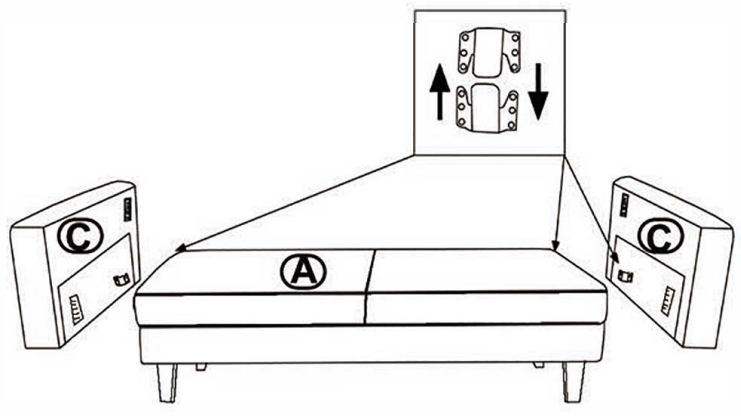

STEP 3

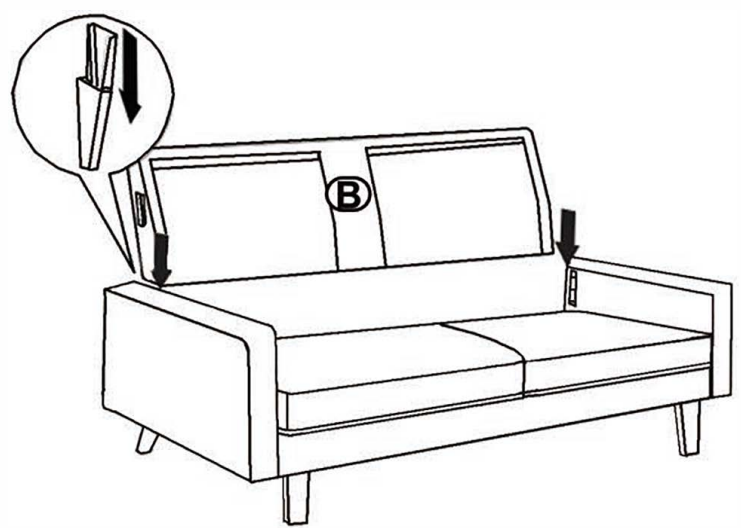

STEP 4

