

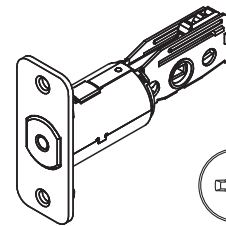

Yale *real* Living

# Yale Real Living® Key Free Push Button Deadbolt B1L Installation and Programming Instructions

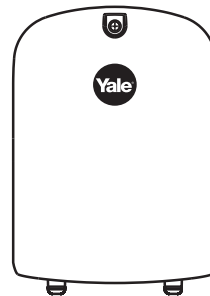
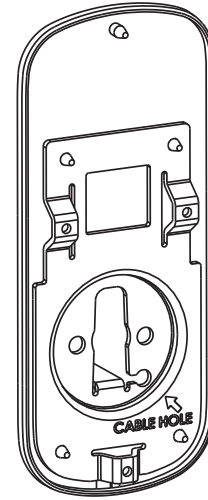
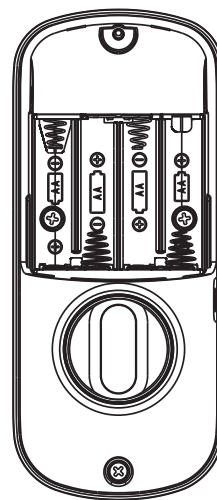
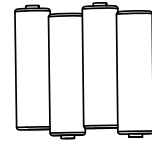
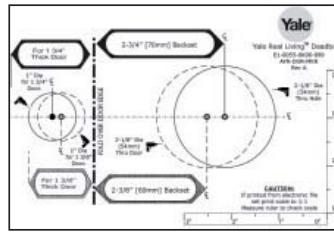

## Before you begin

### DOWNLOAD THE BILT APP

for step-by-step installation  
instructions & to register  
your product



# BILT.



**x4**  
#7 wood & #8-32  
machine x 20mm  
Combination screws



**x3**  
#8-32 x 5/16"  
Machine screws



**x2**  
M6x47mm  
Long through bolt

FAILURE TO FOLLOW THESE INSTRUCTIONS COULD RESULT IN DAMAGE TO  
THE PRODUCT AND VOID THE FACTORY WARRANTY



# Preparing Door

**Yale**  
Yale Real Living® Deadbolt  
E1-6051-0010-000  
A/B-0000000  
Rev. 0

For 1 3/4" Thick Door: 2-3/4" (70mm) Backset, 1" Dia. for 2-3/4" Dia. Hole, 1" Dia. for 2" Dia. Hole

For 2 3/8" Thick Door: 2-3/8" (68mm) Backset, 2-1/8" Dia. (54mm) Dia. Hole, 2-1/8" Dia. (54mm) Dia. Hole

**CAUTION:** If protected from electronic, the lock must be installed on the inside. Measure twice to check once.

# 1

## Installing Latch & Strike Plate



x4

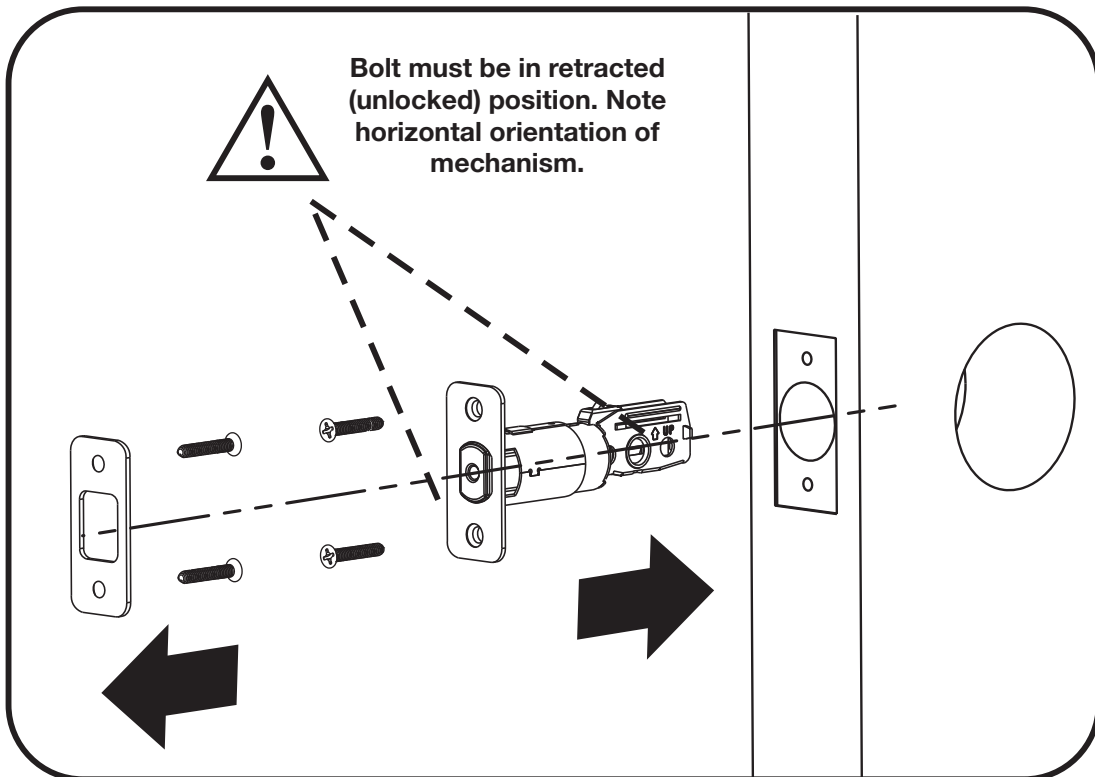
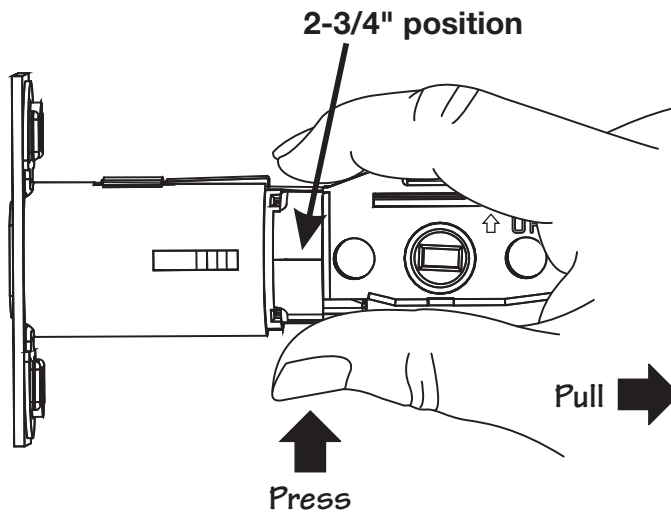
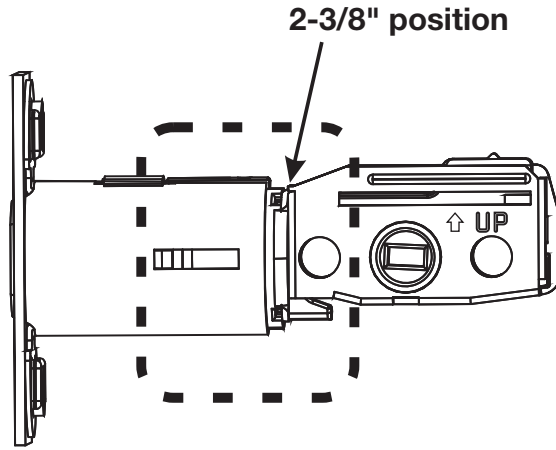

# 2

## Installing Keypad Escutcheon



Inside of Door

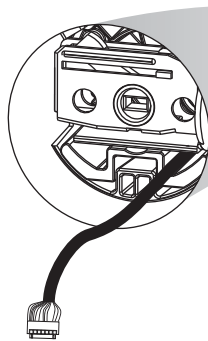

Outside of Door

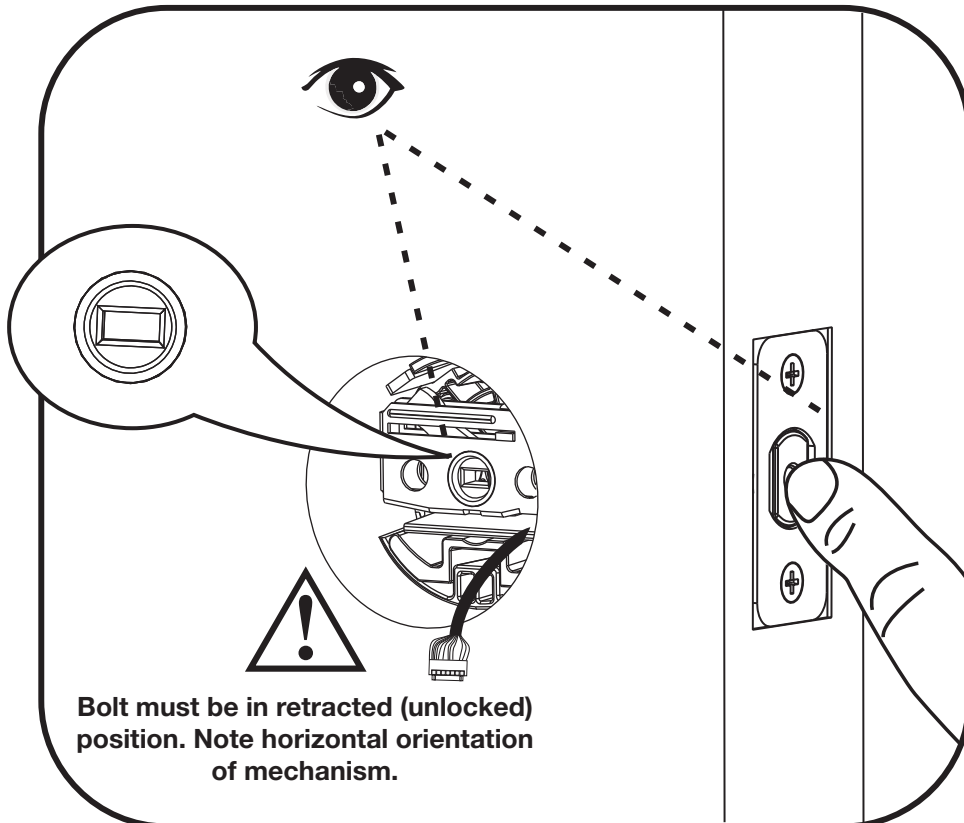
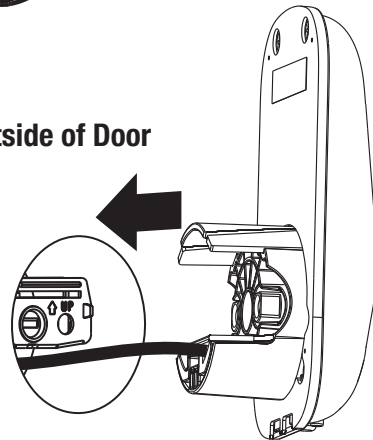

**Bolt must be in retracted (unlocked) position. Note horizontal orientation of mechanism.**

# 3

## Installing Interior Mounting Plate

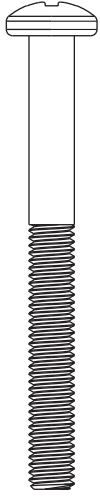

x2

Loosen screw to  
remove cover.

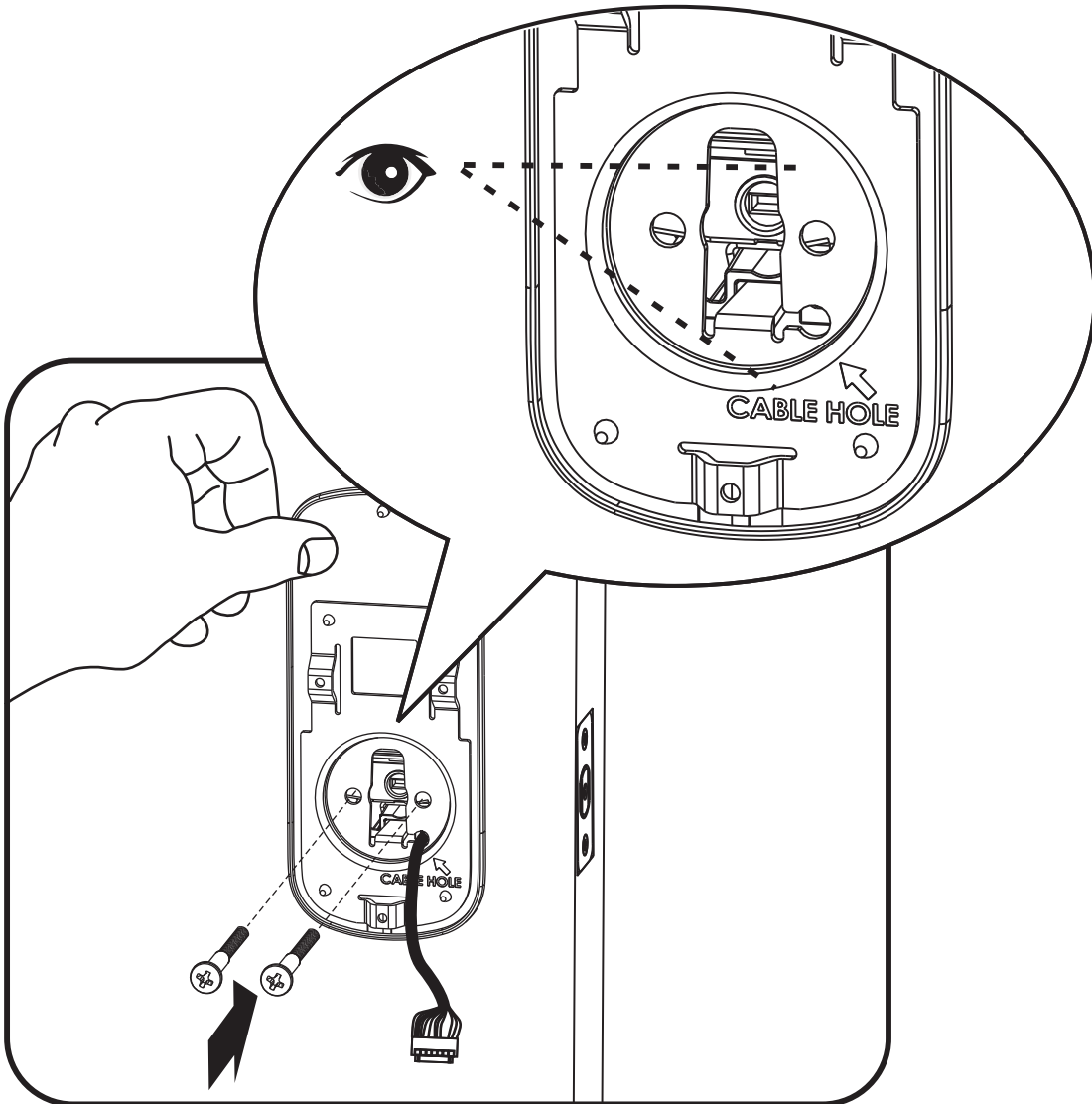
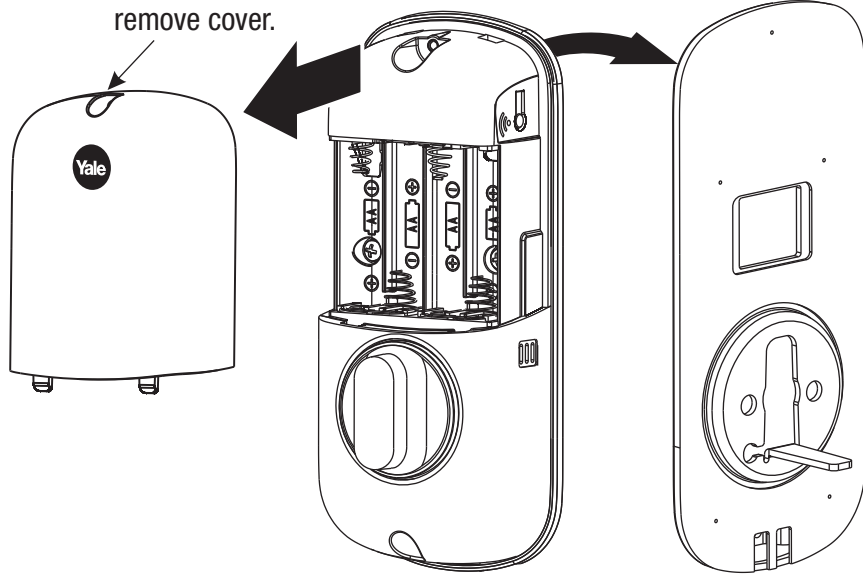

# 4

## Attaching the Cable Assembly

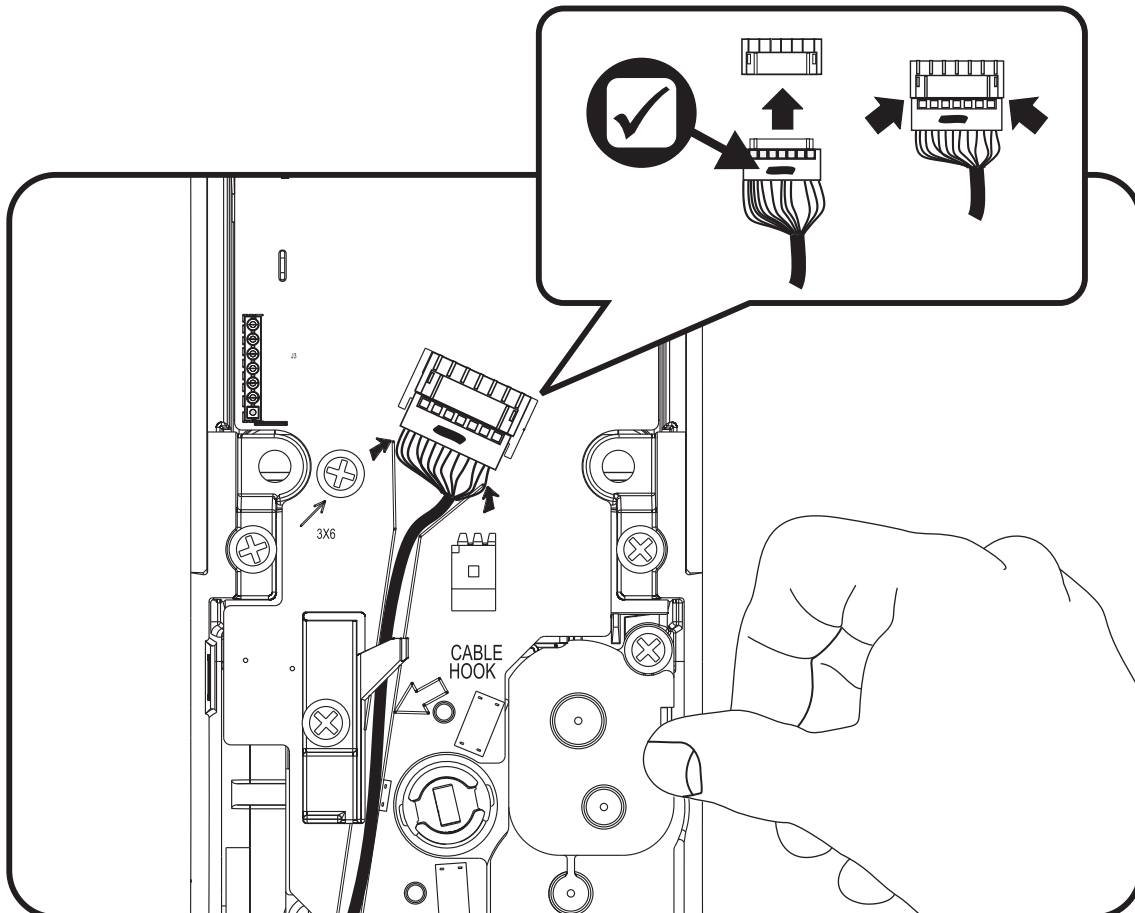
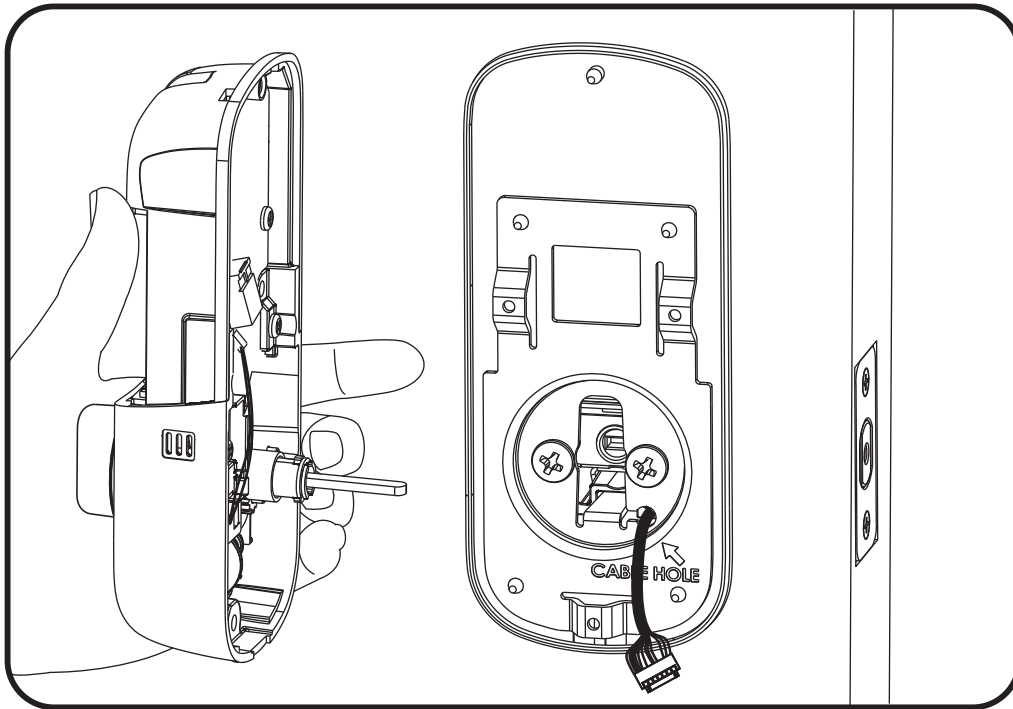

# 5

## Installing Interior Escutcheon



x3

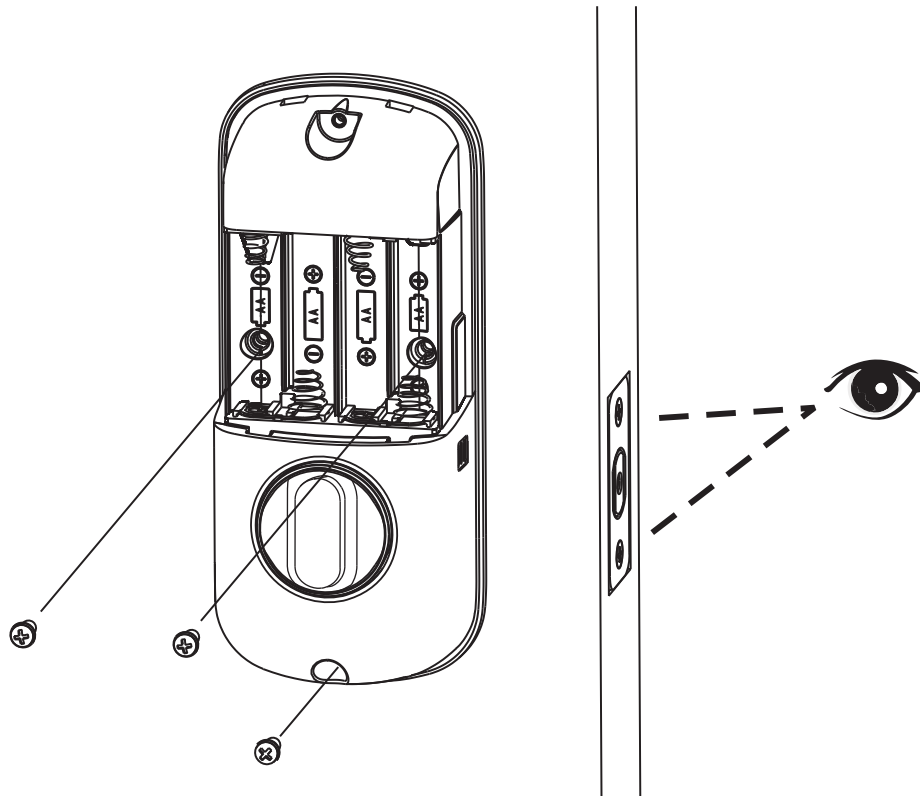
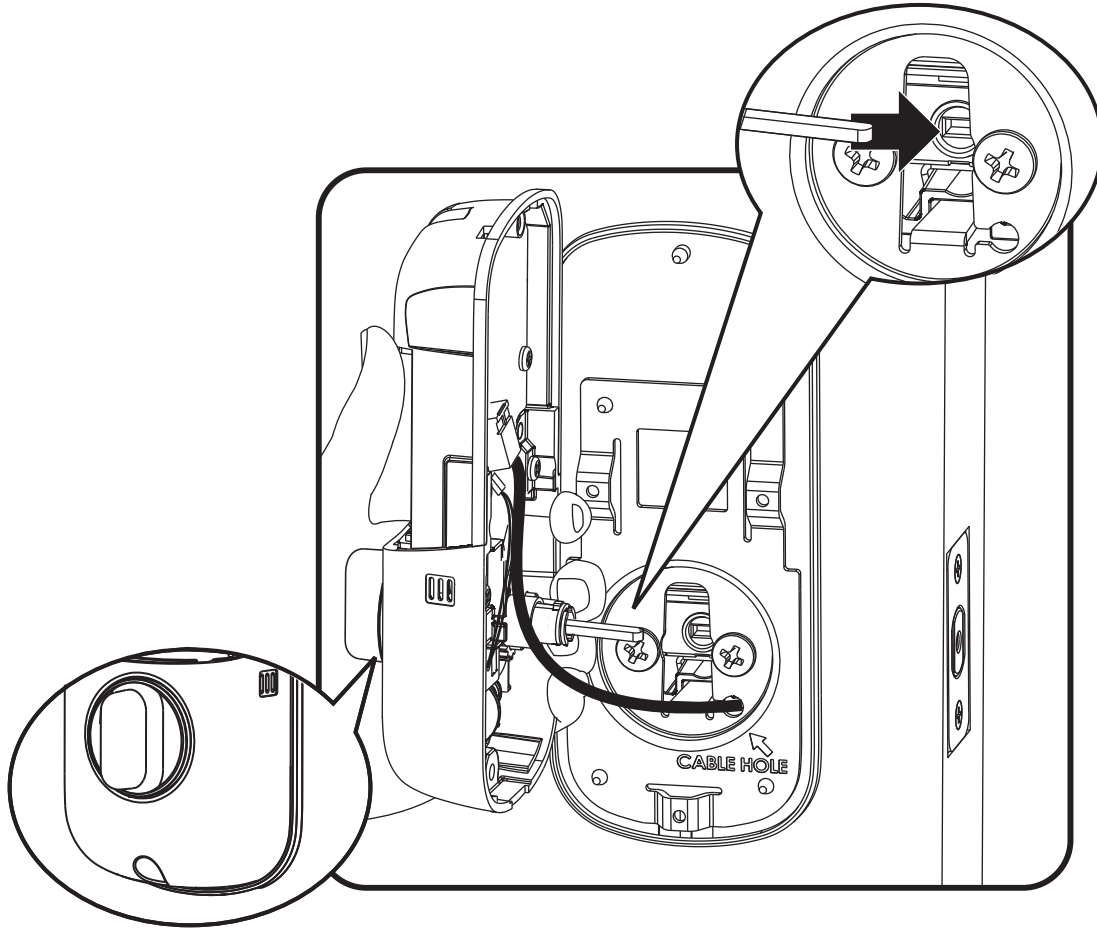



# Testing Operation

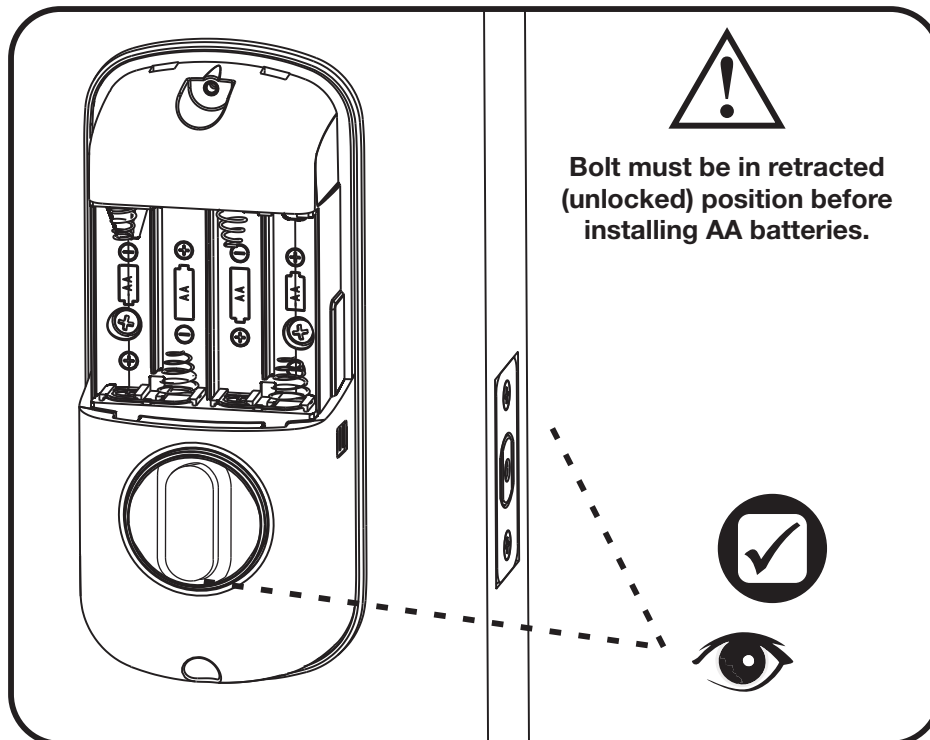
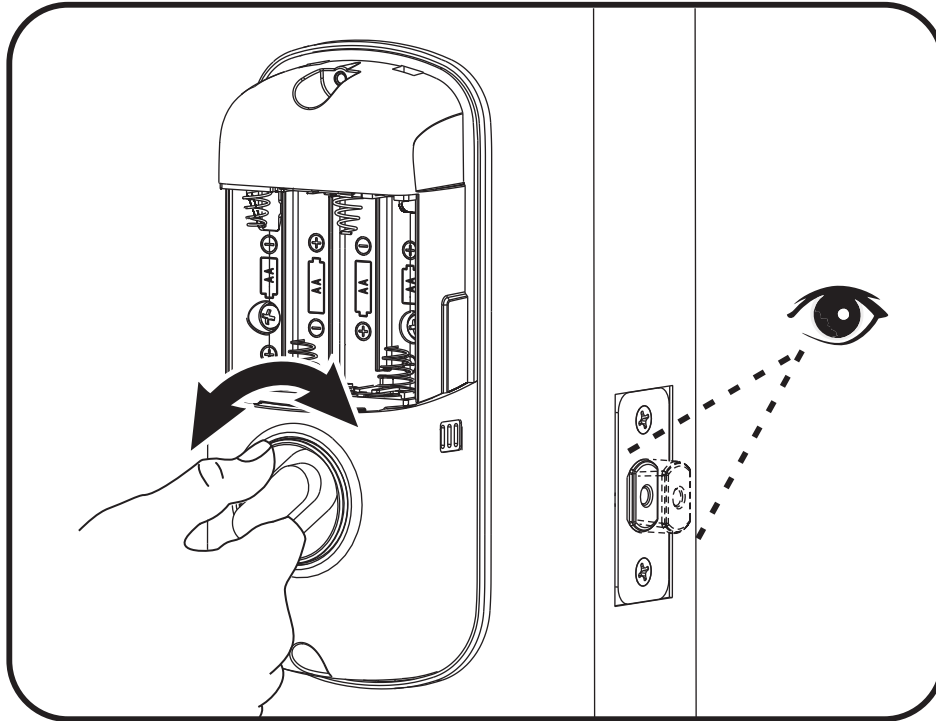

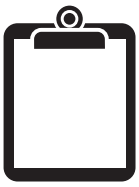

# Handing the Lock

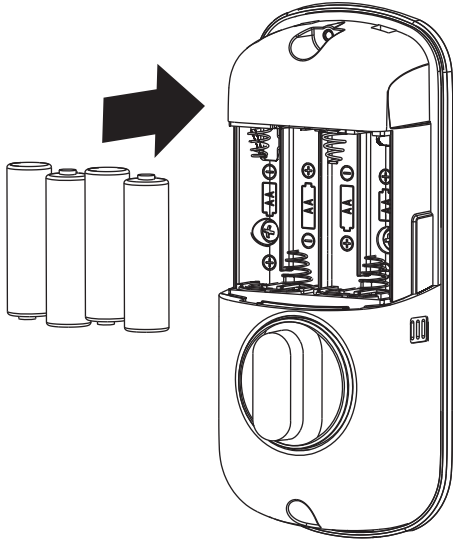

Press . Press **1**. Press . Enter new Master PIN code (4-8 digits). Press to complete.



After entering the Master PIN code, press any key to complete handing.

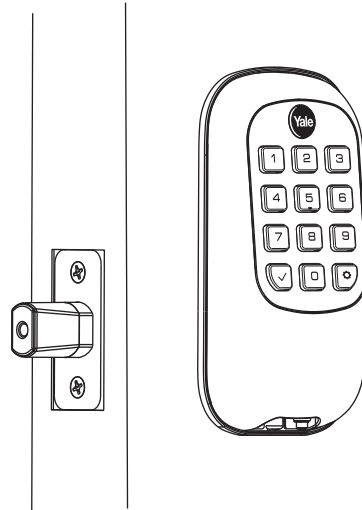

# 6

## Installing Cover

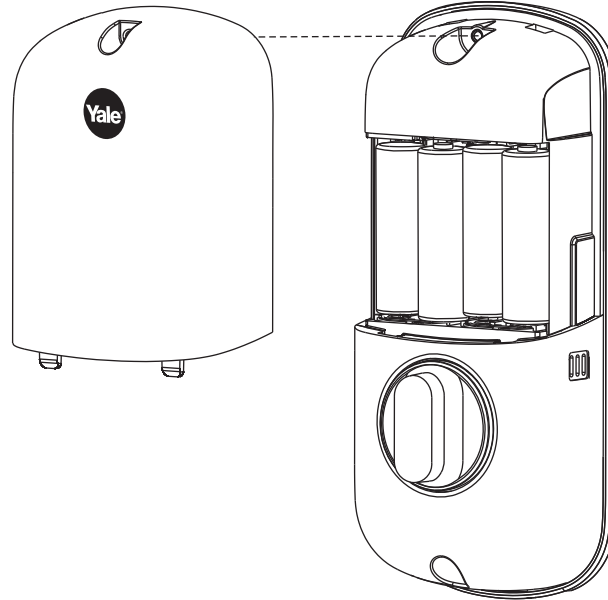

Congratulations, you've installed the Yale Real Living® Key Free Push Button Deadbolt B1L! Turn sheet over for Programming Instructions to customize your product.

# Programming Instructions

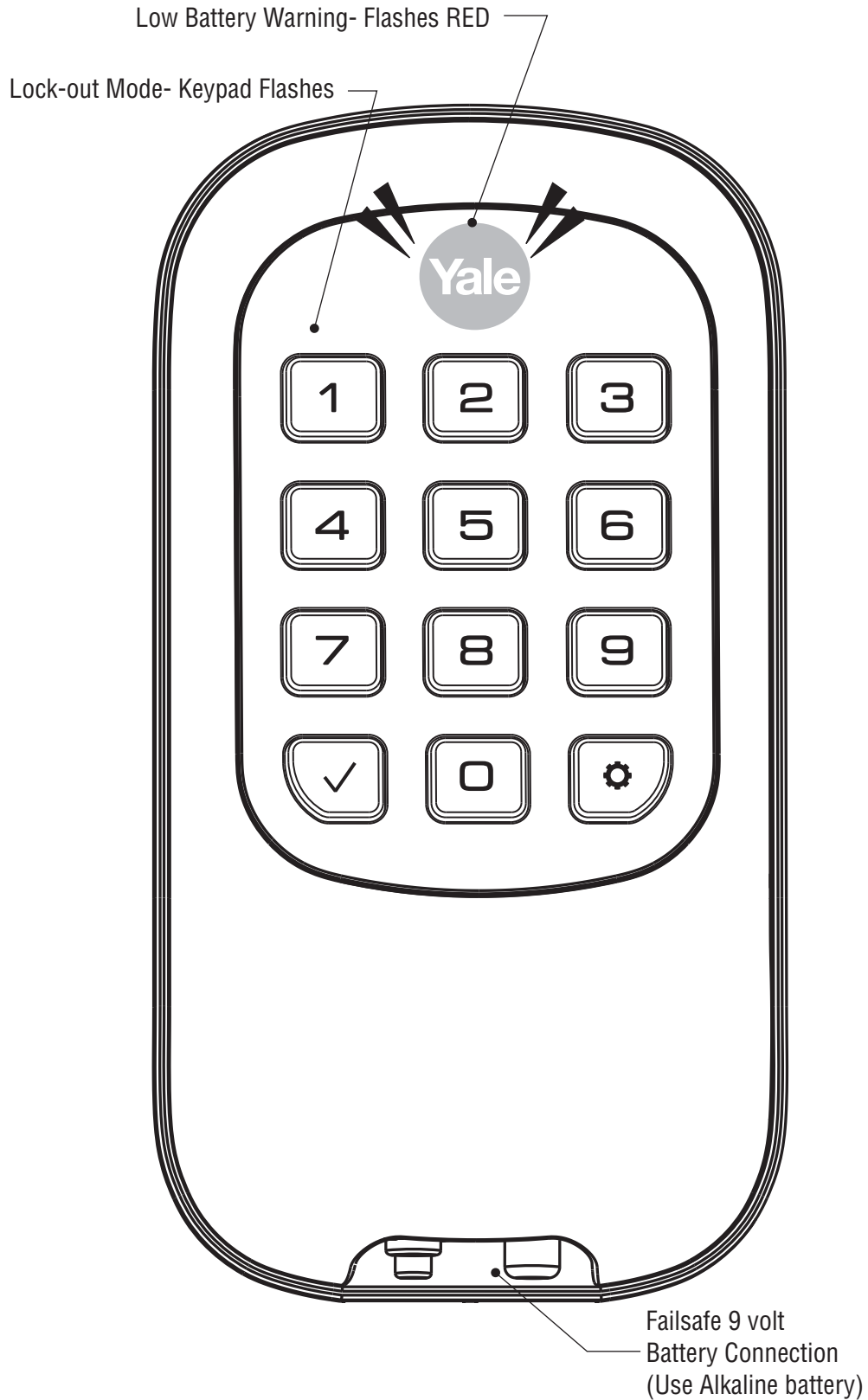

Master PIN Code must be created before any further programming.  
Max User Codes = 25

**Warning:** Changes or modifications to this device, not expressly approved by Yale Security Inc. could void the user's authority to operate the equipment.

# 1

## Creating Master PIN Code

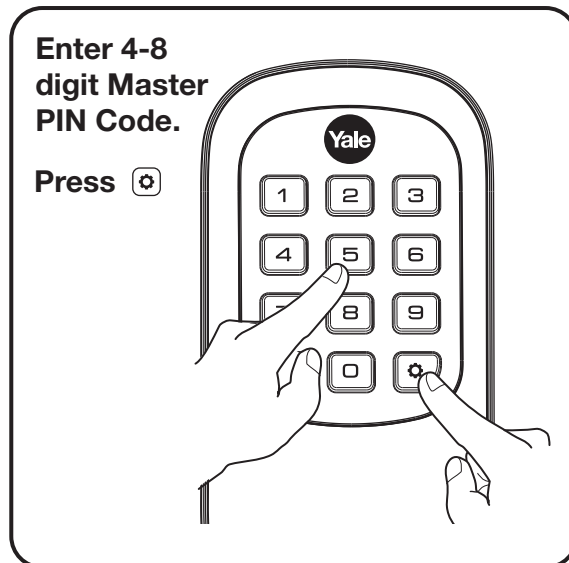
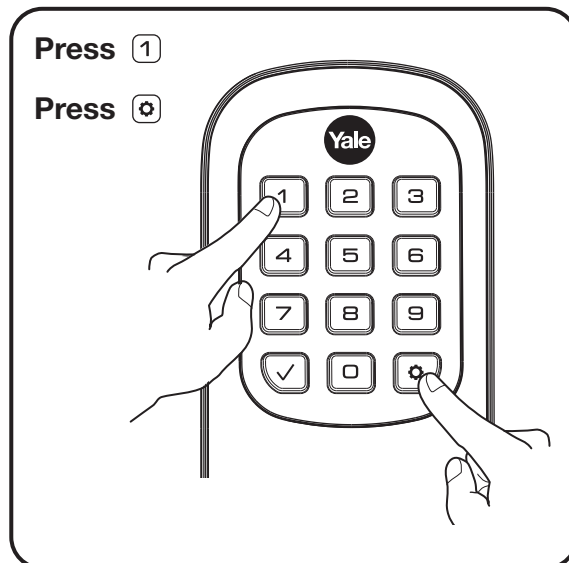
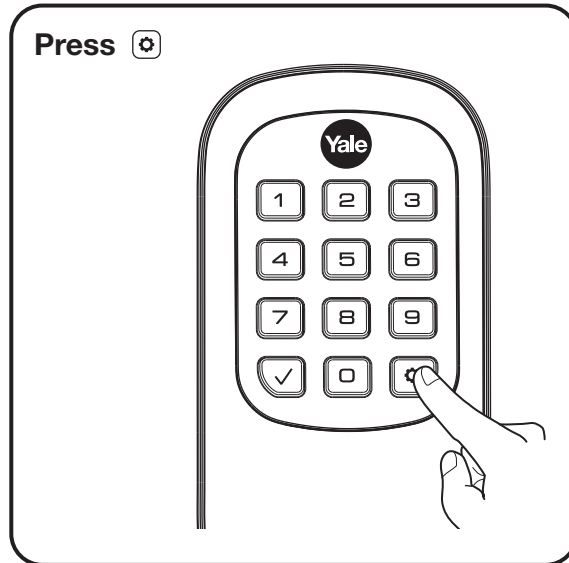

# 2

## Creating User PIN Codes

Master PIN code must be created first.  
\*Max User Codes = 25

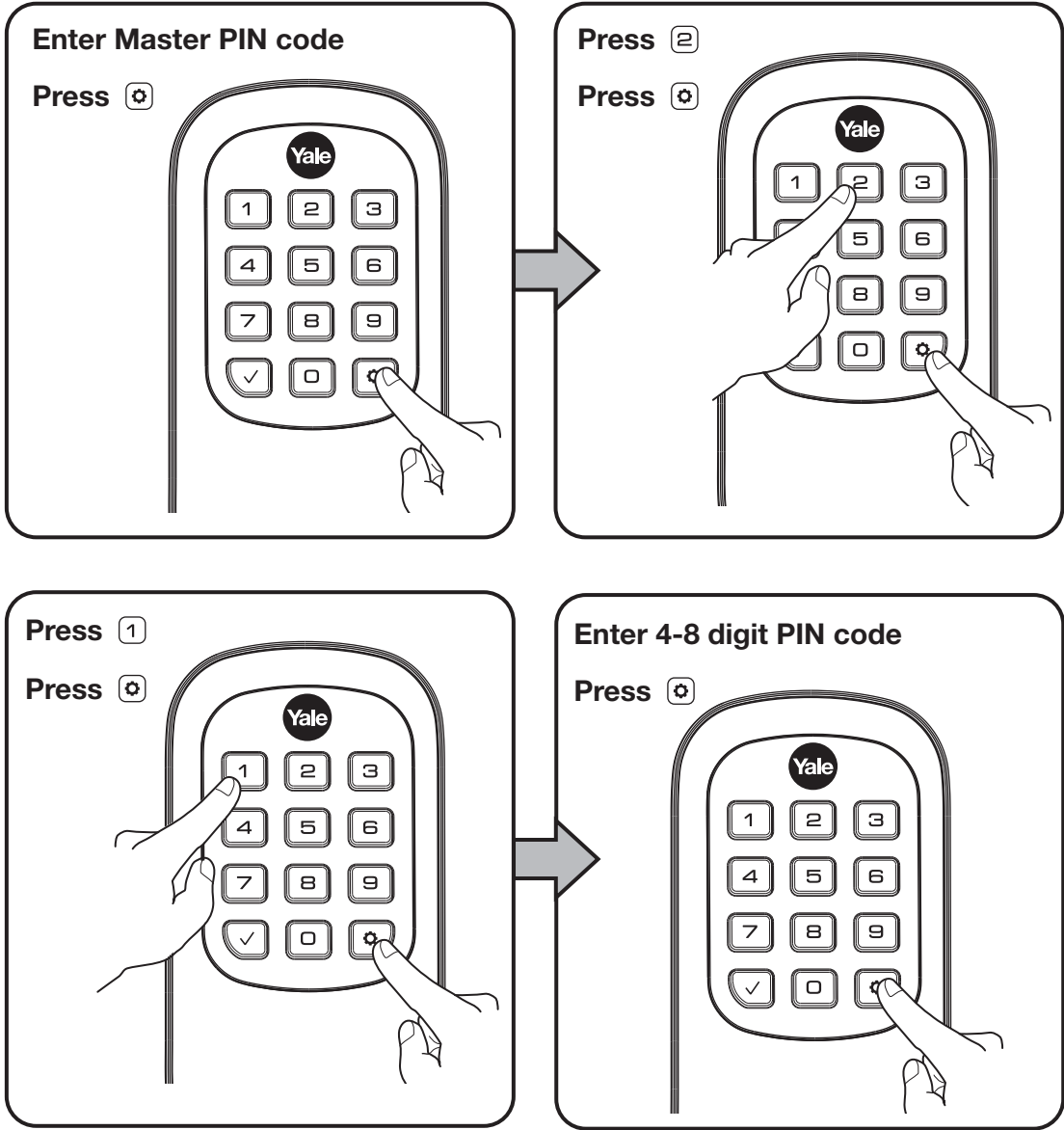



# Resetting Lock to Factory Default

When lock is reset to factory defaults all user codes (including the Master PIN code\*) are deleted and all programming features are reset to original default settings (see "Factory Default Settings").

1. Remove the battery cover.
2. Remove the batteries.
3. While pressing the reset button (minimum of 3 seconds) reinstall batteries. Release reset button.
4. Replace battery cover.

Upon reset, Master Code creation is the only option available and must be performed prior to any other programming of the lock.

NOTE: After setting the Master Code, press any key to complete handing of the lock.

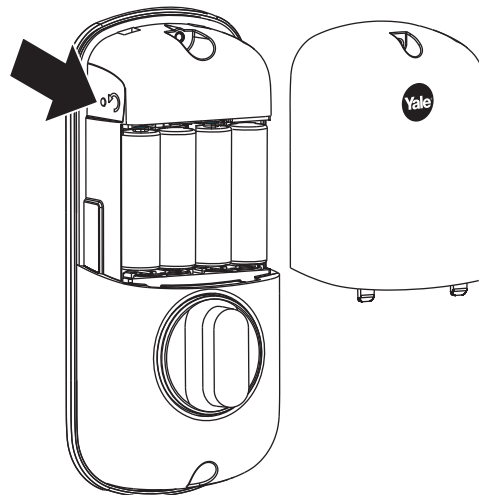

# Definitions

**All Code Lockout Mode:** This feature is enabled by the Master code. When enabled, it restricts all user (except Master) PIN code access. When attempting to enter a code while the unit is in Lockout, the keypad flashes 8 times and the lock beeps 3 times as well.

**Audio Mode:** Choosing **Disable (3)** in Audio mode shuts off the code confirmation tone play-back for use in quiet areas. Audio mode is enabled or disabled through feature programming by the Master code.

**Automatic Re-lock Time:** After a successful unlock, the unit will automatically re-lock after thirty (30) seconds.

**Low Battery:** When battery power is low, the Status Indicator flashes RED. If battery power is completely lost, use the 9Volt battery override. To use the 9V battery override apply 9V battery, in either direction, to terminals below the keypad for backup power option. Wake up the lock and enter your pin code to unlock the door.

**Master PIN Code:** The Master PIN code is used for programming and for feature settings. **It must be created prior to programming the lock.** The Master code will also operate (unlock/lock) the lock.

**One Touch Locking:** When the latch is retracted, activating the keypad will extend the latch (during Automatic Re-lock duration or when Automatic Re-lock is disabled).



**Shutdown Time:** The unit will shut down (flashing keypad) for sixty (60) seconds and not allow operation after the wrong code entry limit has been met.

**Tamper Alert:** Audible alarm sounds if attempting to forcibly remove outside lock from door.

**User PIN Code:** The User code operates the lock. Maximum number of user codes is 25.

**Wrong Code Entry Limit:** After five (5) unsuccessful attempts at entering a valid PIN code, the unit will shut down and not allow operation.

# Feature Programming Through Menu Mode Using Master PIN code\*

1. Enter the 4-8 digit Master PIN code followed by the  key.
2. Enter digit corresponding to the function to be performed followed by the  key.

\*The Master PIN code must be registered prior to any other programming of the lock.

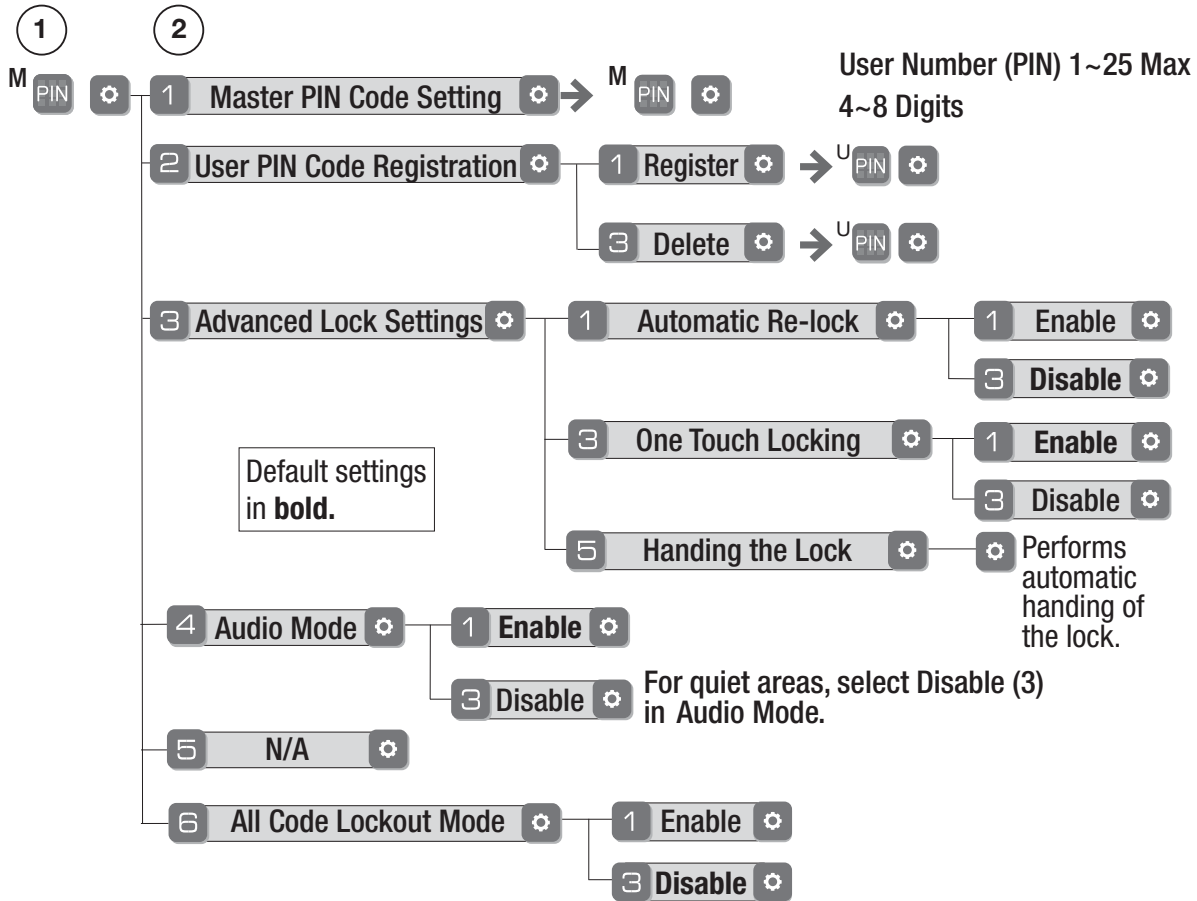

## Factory Settings

Settings	Factory Setting
Master PIN Code	Registration <i>required*</i>
Automatic Re-lock	Disabled
One Touch Locking	Enabled
Audio	Enabled
Automatic Re-lock Time	30 Seconds
Wrong Code Entry Limit	5 Times
Shutdown Time	60 Seconds

\*The Master PIN code must be registered prior to any other programming of the lock.

# Programming Troubleshooting

Symptom	Suggested Action
Lock does not respond – door is open and accessible.	<ul style="list-style-type: none"> <li>• Press each keypad button for response when pressed.</li> <li>• Check batteries are installed and oriented correctly (polarity) in the battery case.</li> <li>• Check batteries are in good condition; replace batteries if discharged.</li> <li>• Check to see if cable is fully connected and not pinched.</li> </ul>
Lock does not respond – door is locked and inaccessible.	<ul style="list-style-type: none"> <li>• Batteries may be completely discharged.</li> <li>• Apply 9V battery to terminals below the keypad for backup power option.</li> </ul>
Unit chimes to indicate code acceptance, but the door will not open.	<ul style="list-style-type: none"> <li>• Check to see if there is another locking device on the door.</li> <li>• Check the door gaps for any foreign objects between door and frame.</li> <li>• Check that the cable is firmly connected to the PC board.</li> </ul>
Unit operates to allow access, but will not automatically re-lock.	<ul style="list-style-type: none"> <li>• Check to see if Auto Re-lock Mode is enabled.</li> <li>• If low battery indicator is lit (see below), change batteries.</li> </ul>
PIN codes will not register.	<ul style="list-style-type: none"> <li>• PIN codes must consist of 4 to 8 digits to register.</li> <li>• The same PIN code cannot be used for multiple users.</li> <li>• Registration/management of PIN codes is set by the authority of the Master Code.</li> <li>• Contact the Master user.</li> <li>• User codes must be entered within 5 seconds or the process will have to be restarted.</li> <li>• Check mark <input type="checkbox"/> or gear <input type="checkbox"/> cannot be used as part of the PIN code.</li> </ul>
Upon entering a PIN code and pressing the <input type="checkbox"/> key, the lock gives a series of beeps, flashes red & blue LEDs 7 times, and does not unlock.	<ul style="list-style-type: none"> <li>• All Code Lockout Mode is enabled.</li> <li>• Only the Master can enable/disable All Code Lockout Mode.</li> <li>• Contact the Master user.</li> </ul>
Upon entering a PIN code and pressing the <input type="checkbox"/> key, there are different tones.	<ul style="list-style-type: none"> <li>• Check to see if the lock is set to All Code Lockout Mode.</li> <li>• Setting/managing All Code Lockout Mode is done through Master Code only. Contact the Master user.</li> </ul>
The unit operates, but it makes no sound.	<ul style="list-style-type: none"> <li>• Enable Audio Mode.</li> </ul>
The unit displays intermittent RED flashes.	<ul style="list-style-type: none"> <li>• This is the Low Battery indicator alerting that it is time to replace the batteries. Replace all four (4) batteries with new AA Alkaline batteries.</li> </ul>
Upon entering a PIN code and pressing the <input type="checkbox"/> key, the unit responds with a series of beeps and the keypad flashes three times.	<ul style="list-style-type: none"> <li>• The digits entered were incorrect or incomplete. Re-enter the correct code followed by the check mark <input type="checkbox"/> key.</li> </ul>

**FCC:**

This equipment has been tested and found to comply with the limits for a Class B digital device, pursuant to Part 15 of the FCC Rules. These limits are designed to provide reasonable protection against harmful interference in a residential installation. This equipment generates, uses, and can radiate radio frequency energy and, if not installed and used in accordance with the instructions, may cause harmful interference to radio communications. However, there is no guarantee that interference will not occur in a particular installation. If this equipment does cause harmful interference to radio or television reception, which can be determined by turning the equipment off and on, the user is encouraged to try to correct the interference by one or more of the following measures:

- Reorient or relocate the receiving antenna.
- Increase the separation between the equipment and receiver.
- Connect the equipment into an outlet on a circuit different from that to which the receiver is connected.
- Consult the dealer or an experienced radio/TV technician for help.

**Industry Canada:**

This Class B digital apparatus meets all requirements of the Canadian Interference Causing Equipment Regulations. Operation is subject to the following two conditions: (1) this device may not cause harmful interference, and (2) this device must accept any interference received, including interference that may cause undesired operation.

Cet appareillage numérique de la classe B répond à toutes les exigences de l'interférence canadienne causant des règlements d'équipement. L'opération est sujette aux deux conditions suivantes: (1) ce dispositif peut ne pas causer l'interférence nocive, et (2) ce dispositif doit accepter n'importe quelle interférence reçue, y compris l'interférence qui peut causer l'opération peu désirée.

**NOTE TO INSTALLER AND CONSUMER**

While Yale® has included several features to prevent lockout (9-Volt battery jumper, low battery warnings), it is still possible for a lockout situation to occur. Because this product does not have a mechanical override (a key), Yale® recommends to use this product in an environment where there are additional entry points into the dwelling.

## **Yale Locks & Hardware**

Product Support Tel 800.810.WIRE (9473) • [www.yalelocks.com](http://www.yalelocks.com)

Yale Locks & Hardware is a division of Yale Security Inc., an ASSA ABLOY Group company.

Yale® and Yale Real Living® are registered trademarks of Yale Security Inc., an ASSA ABLOY Group company.

Copyright © 2017, Yale Security Inc., an ASSA ABLOY Group company.

All rights reserved. Reproduction in whole or in part without the express written permission of Yale Security Inc. is prohibited.

**YALE**, with its unique global reach and range of products, is the world's favorite lock – the preferred solution for securing your home, family and personal belongings.

**ASSA ABLOY** is the global leader in door opening solutions, dedicated to satisfying end-user needs for security, safety and convenience.