

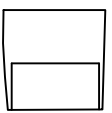

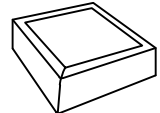

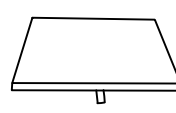

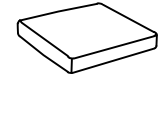
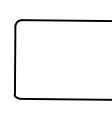

Accessories list

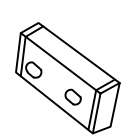
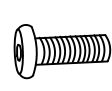

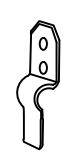

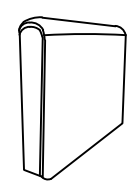
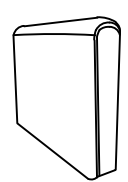

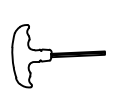

1 Seater

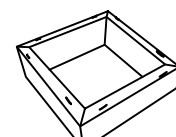
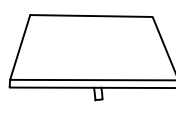
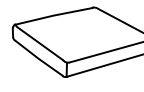
<p>A</p>  <p>Backrest(1)</p>	<p>B</p>  <p>Seat frame(1)</p>	<p>C</p>  <p>Seat frame cover plate(1)</p>	<p>D</p>  <p>Seat cushion(1)</p>	<p>E</p>  <p>Back cushion(1)</p>	<p>F</p>  <p>Sofa feet(4)</p>
<p>G</p>  <p>Square hardware(4)</p>	<p>H</p>  <p>6*38mm Screw(12)</p>	<p>I</p>  <p>Gasket(8)</p>	<p>J</p>  <p>Wrench(1)</p>	<p>K</p>  <p>Hardware(2)</p>	<p>L</p>  <p>U connector(2)</p>
<p>M</p>  <p>Woolenmet(4)</p>					

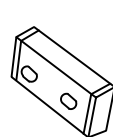
Armrest

<p>N</p>  <p>Right armrest(1)</p>	<p>O</p>  <p>Left armrest(1)</p>	<p>K</p>  <p>Hardware(4)</p>	<p>H</p>  <p>6*38mm Screw(8)</p>	<p>J</p>  <p>Wrench(1)</p>
--	---	---	---	---

Ottoman

<p>P</p>  <p>Ottoman seat frame(1)</p>	<p>Q</p>  <p>Ottoman panel(1)</p>	<p>D</p>  <p>Ottoman seat cushion(1)</p>	<p>F</p>  <p>Sofa feet(4)</p>	<p>G</p>  <p>Square hardware(4)</p>	
<p>H</p>  <p>Screw(8)</p>	<p>I</p>  <p>Gasket(8)</p>	<p>J</p>  <p>Wrench(1)</p>	<p>L</p>  <p>U connector(2)</p>	<p>M</p>  <p>Woolenmet(4)</p>	<p>R</p>  <p>Velcro(2)</p>

STEP 1:

Turn over the sofa base and install the sofa feet

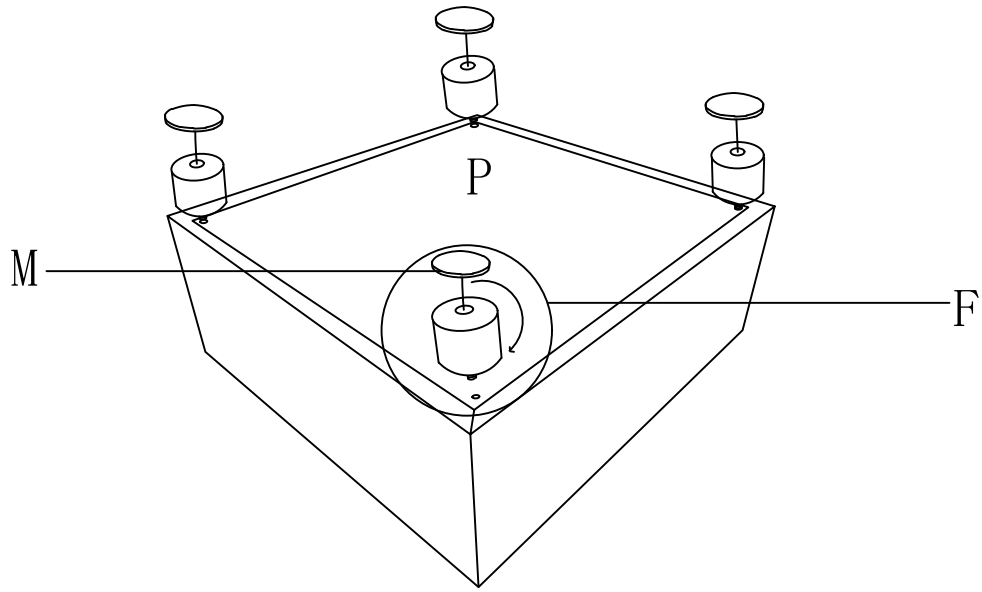

STEP 2:

Screw the square hardware into the sofa base with hexagon scwdriver

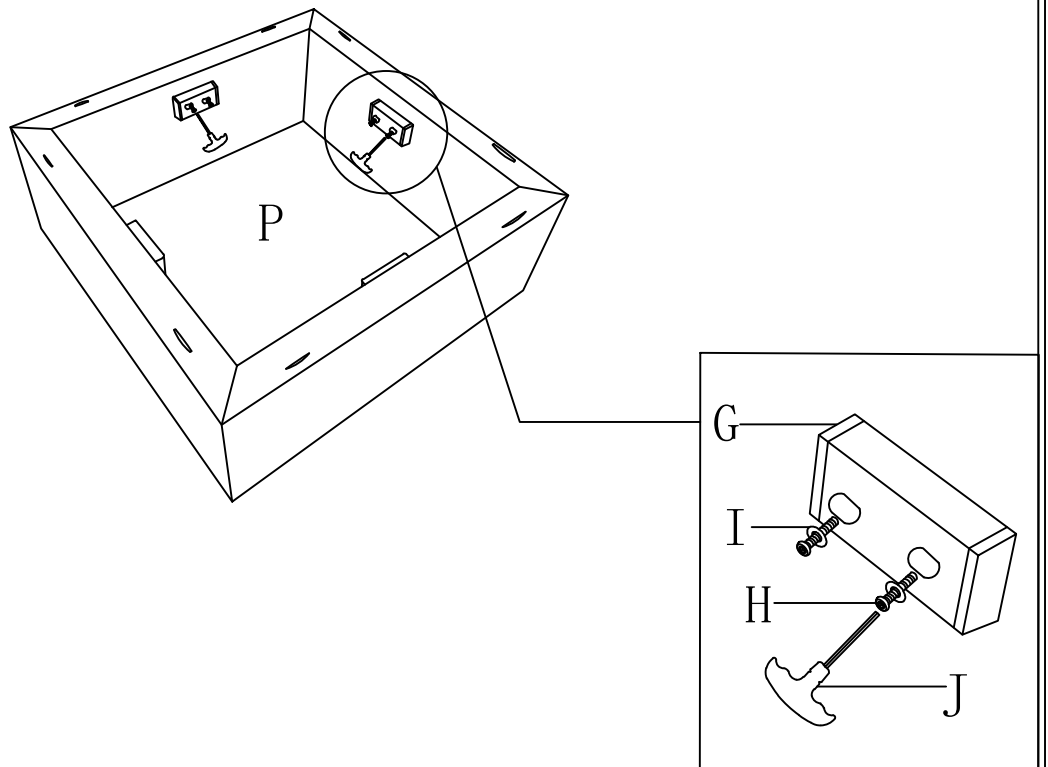

STEP 3:

Screw the Z-shaped hardware into the sofa armrest and backrest with hexagon screwdriver

*Please note: Four Z-shaped hardware and screws are inside the bottom of the armrest

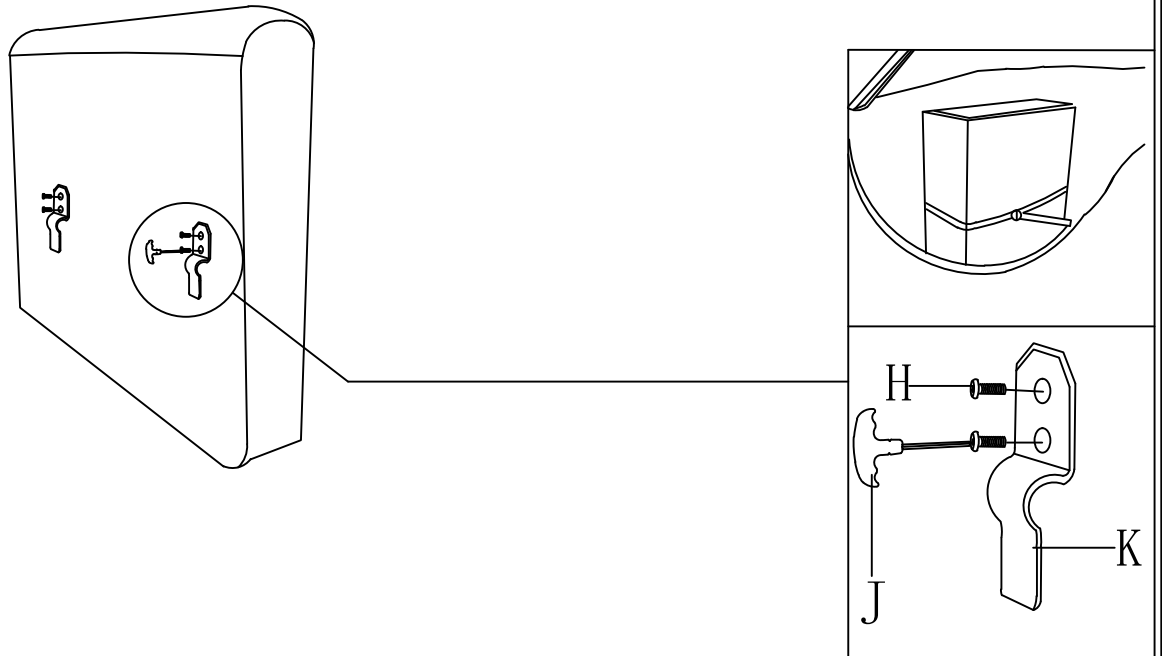

STEP 4:

Insert the backrest into the sofa base first, and then insert armrests

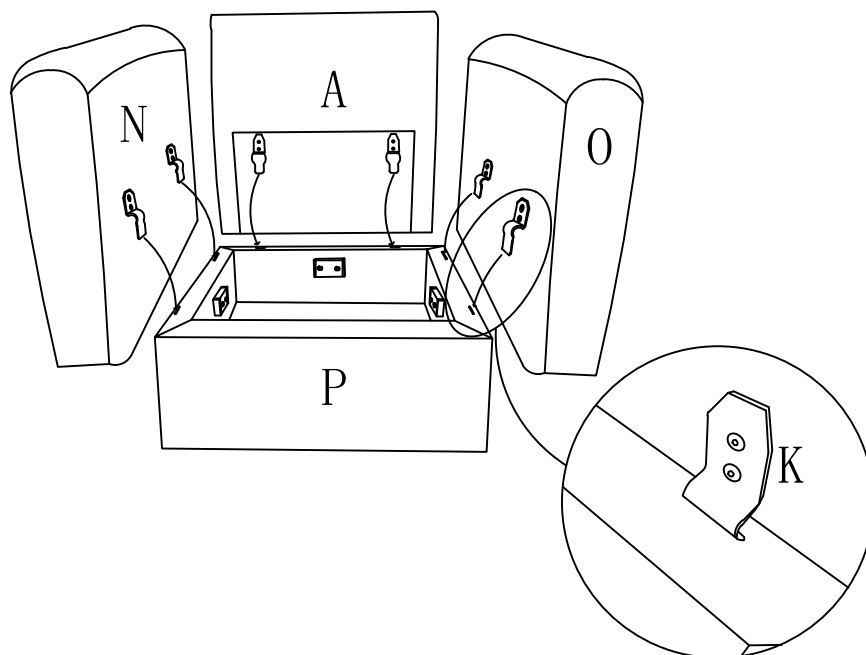

STEP 5:

Put the sofa base cover

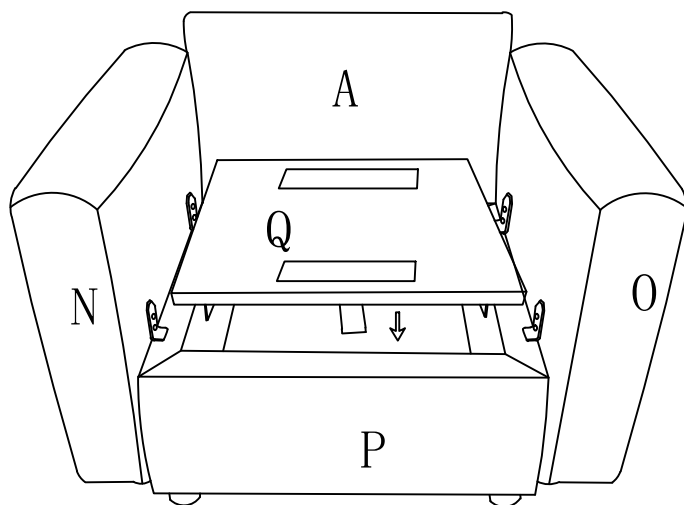

STEP 6:

Open the compression cushion bags with scissor

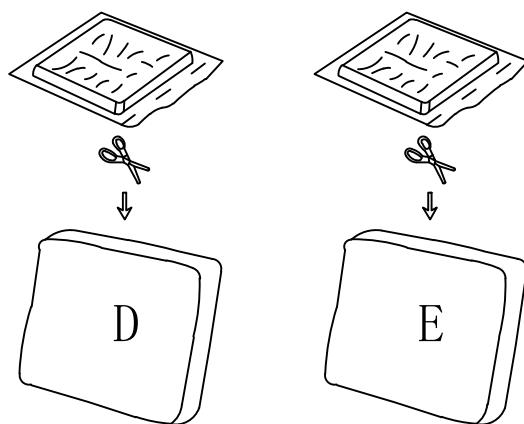

STEP 7:

First, place the seat board on the seat frame, then attach the Velcro to the seat board, and finally place the seat cushion

NOTE:The velcro is only used on ottoman .

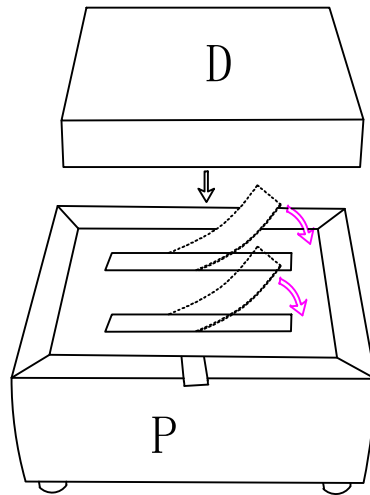

STEP 8:

Put the sofa seat cushion and back cushion on the sofa
On the frame, such a single sofa is assembled

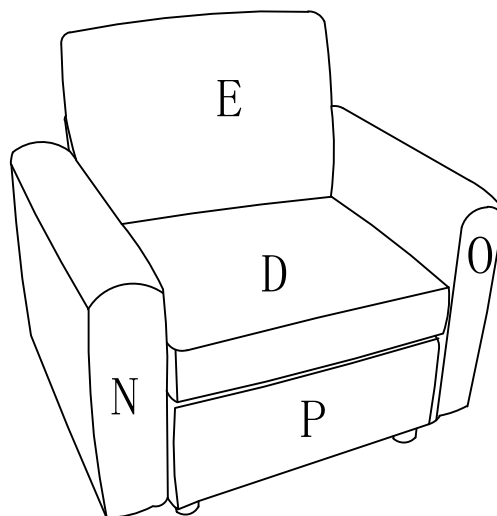

STEP 9:

If you need double seat, triple seat or imperial concubine seat, just connect the sofa base with U-shaped hardware, insert the backrest armrest and put the seat cushion on the seat cushion

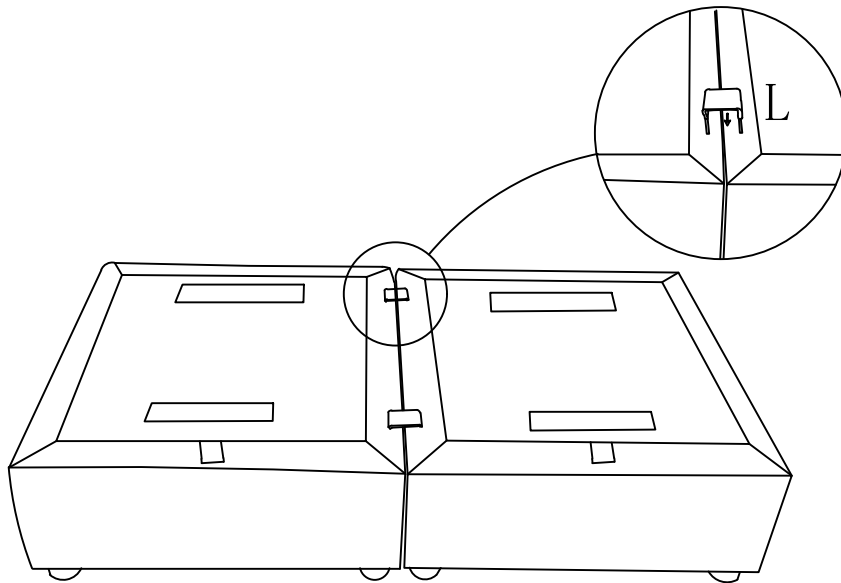

STEP 10:

Assembly completed

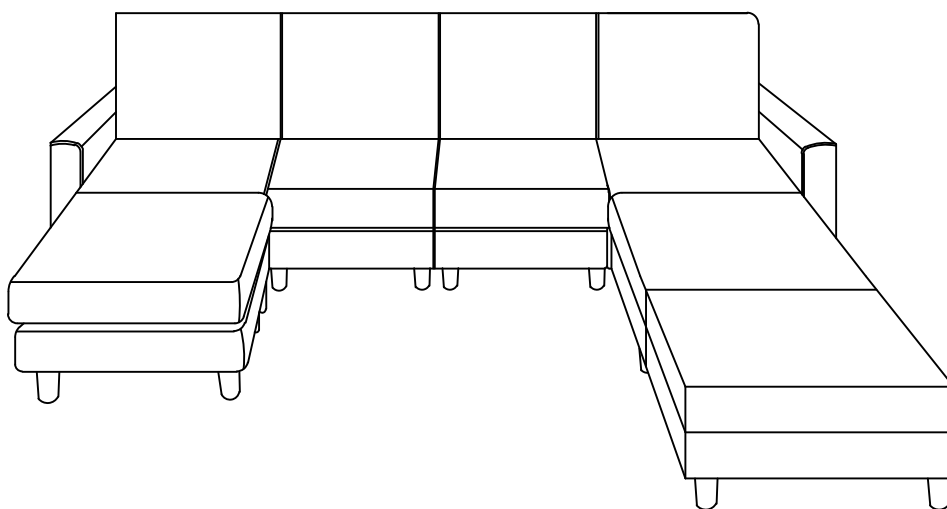

STEP 11:
Assembly completed

