

MANUAL INSTRUCTION

Metal Gazebo 12'X20'FT
G30007

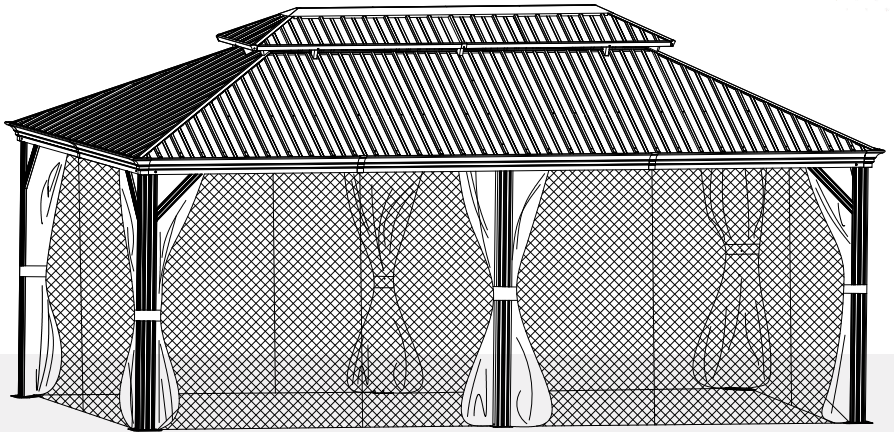

 Metal Gazebo 12'X20'FT G30007

We offer a diverse range of products to meet the needs of customers.

Outdoor Furniture

We are a professional furniture provider with top-notch factories and outstanding designs, Our mission is to provide consumers with new lifestyles. By collecting consumer feedback, we constantly improve our products and create more choices for consumers. If you want to create your space, We are an ideal choice.

Always.

WARNING

- In case of windy weather, please do not stand in the gazebo.
- Please do not stand under the gazebo in case of heavy snowfall.
- For safety, please use expansion screws to reinforce the posts to the ground.
- In windy weather, please tighten the fence and netting to avoid tearing in high winds.
- In extreme weather conditions, you can use a rope to pull the four corners of the gazebo to keep it stable.
- Please clear the snow off the roof in time for the heavy snowfall.
- Make sure all screws are tightened before use.
- Repeat to confirm all screws, buckles and straps every 90 days.
- Please keep all screws loose during the assembly process and tighten them after completing the installation.
- Do not use or store next to a pole with an open flame or flammable chemicals.
- Please note that some parts have sharp edges and should be handled with gloves.
- If any parts are missing, broken, damaged or worn, discontinue use of the product until repairs are made or factory replacement parts are installed.
- Installation of the product in a manner that does not conform to the manufacturer's instructions may result in the loss of the warranty policy for this product.

CALIFORNIA PROPOSITION 65

WARNING: This product can expose you to Carbon monoxide, which is known to the State of California to cause birth defects or other reproductive harm. For more information go to www.P65Warnings.ca.gov

TOOLS REQUIRED

EQUIPMENT REQUIRED (Not included in boxes)

*NOTE: Tools / equipment are not shown to actual size and scale.



LEVEL



RUBBER MALLET



PHILLIPS SCREW



DRILL



ALLEN KEY

EQUIPMENT REQUIRED (Not included in boxes)

*NOTE: Equipment are not shown to actual size and scale.



SAFETY HAT



GLOVES



SAFETY GOGGLES



STEPLADDER
(6.5Ft Or More)

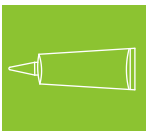

GLUE

Matters needing attention



*Three or more people
are required for
assemblee*



*Do not fully tighten
screws prior to complete
assembly*

PARTS

A

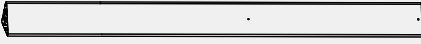

4 PCS

A1



8 PCS

A2



8 PCS

B



2 PCS

B1



4 PCS

C

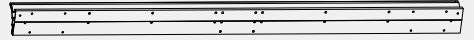

2 PCS

C1a



2 PCS

C1b



2 PCS

D

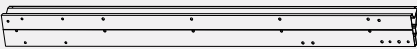

4 PCS

D1

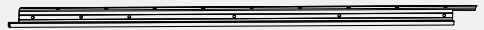

2 PCS

D2



2 PCS

E

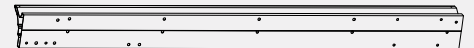

4 PCS

E1



2 PCS

E2



2 PCS

PARTS

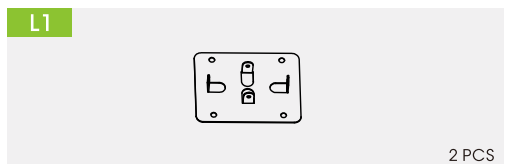
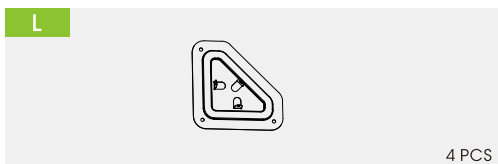
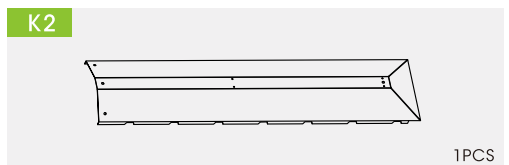
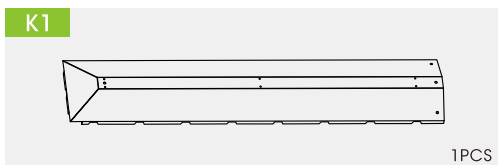
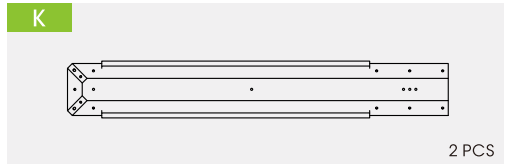
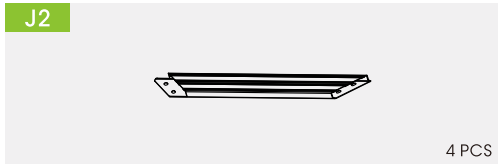
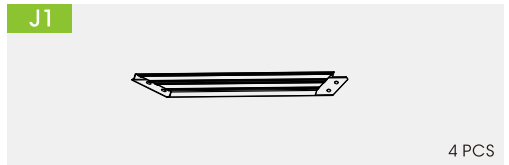
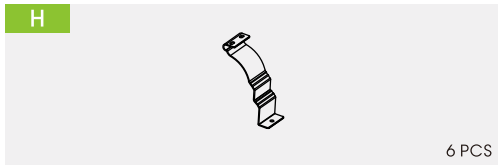
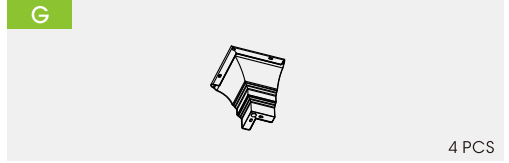
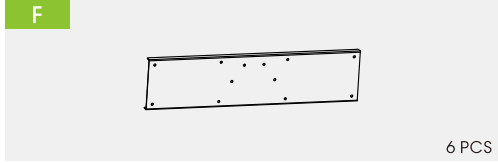

PARTS

N2

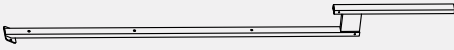

2 PCS

P

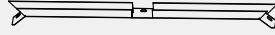

2 PCS

P1

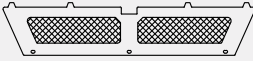

2 PCS

Q1

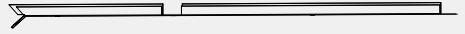

2 PCS

Q2



2 PCS

Q3

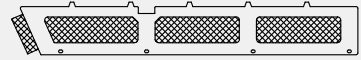

2 PCS

Q4

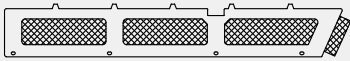

2 PCS

Q5

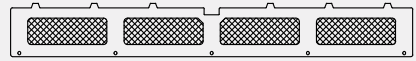

2 PCS

R



8 PCS

R1



2 PCS

S



152 PCS

S1



12 PCS

T



2 PCS

T1



2 PCS

PARTS

T2



2 PCS

U1

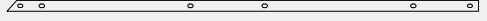

4 PCS

U2

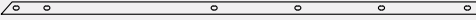

4 PCS

U3



4 PCS

U4

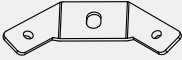

4 PCS

U5

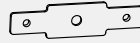

8 PCS

Z



68 PCS

Z1



20 PCS

PARTS

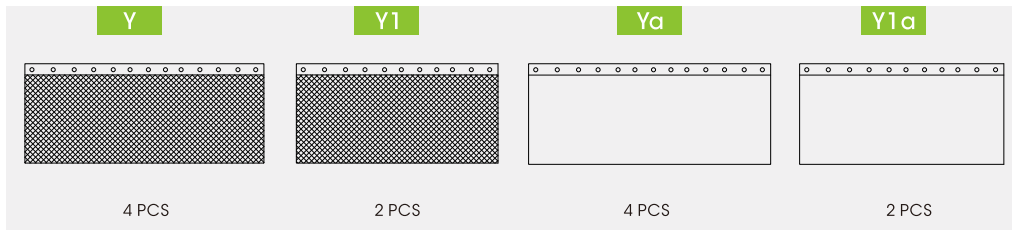
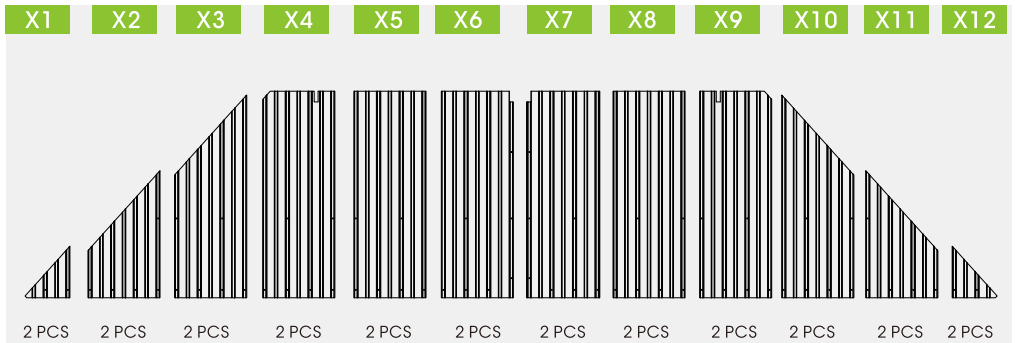
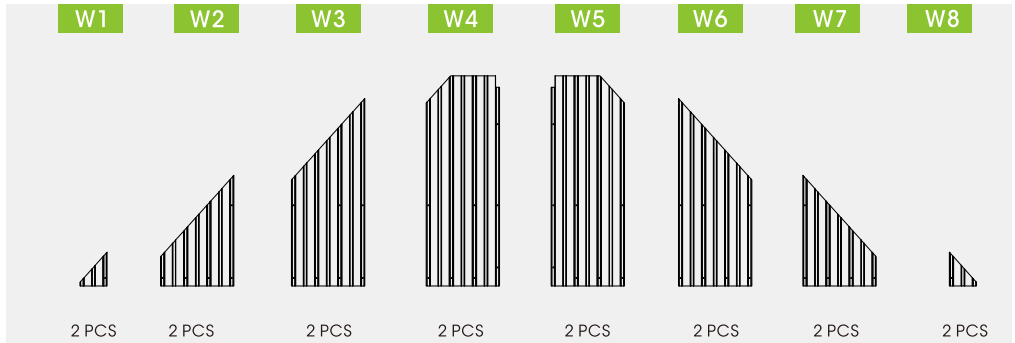
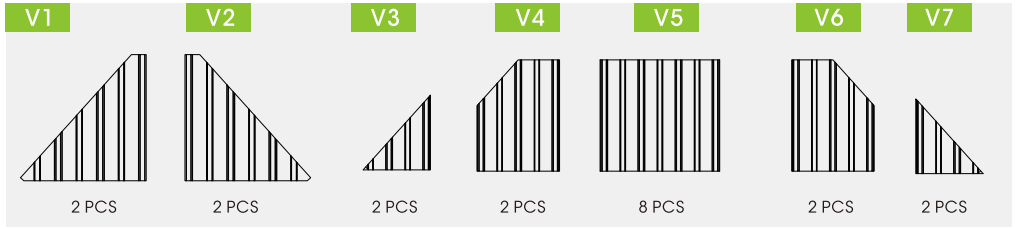

HARDWARE

1# M6x16mm



269+5 PCS

2# M6x20mm

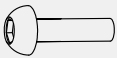

36 PCS

3#

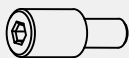

16 PCS

4#

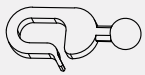

152 PCS

5# M6x23mm

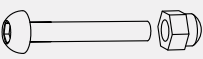

100 PCS

6# M6x47mm



44 PCS

7# M6x42mm

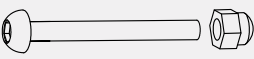

4 PCS

8# M5x16mm



40 PCS

9# ST4.8x13mm



28 PCS

10# M6x23mm



4 PCS

11# M6x10mm



20 PCS

12#

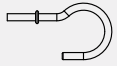

2 PCS

13#



1 PCS

14# M6x50mm

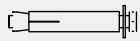

20 PCS

HARDWARE

15# M6x16mm



7 PCS



2 PCS



1 PCS

PRODUCT ASSEMBLY

1 Place part "A" on top of part "L" and use 3 screws "1#" for reinforcement.

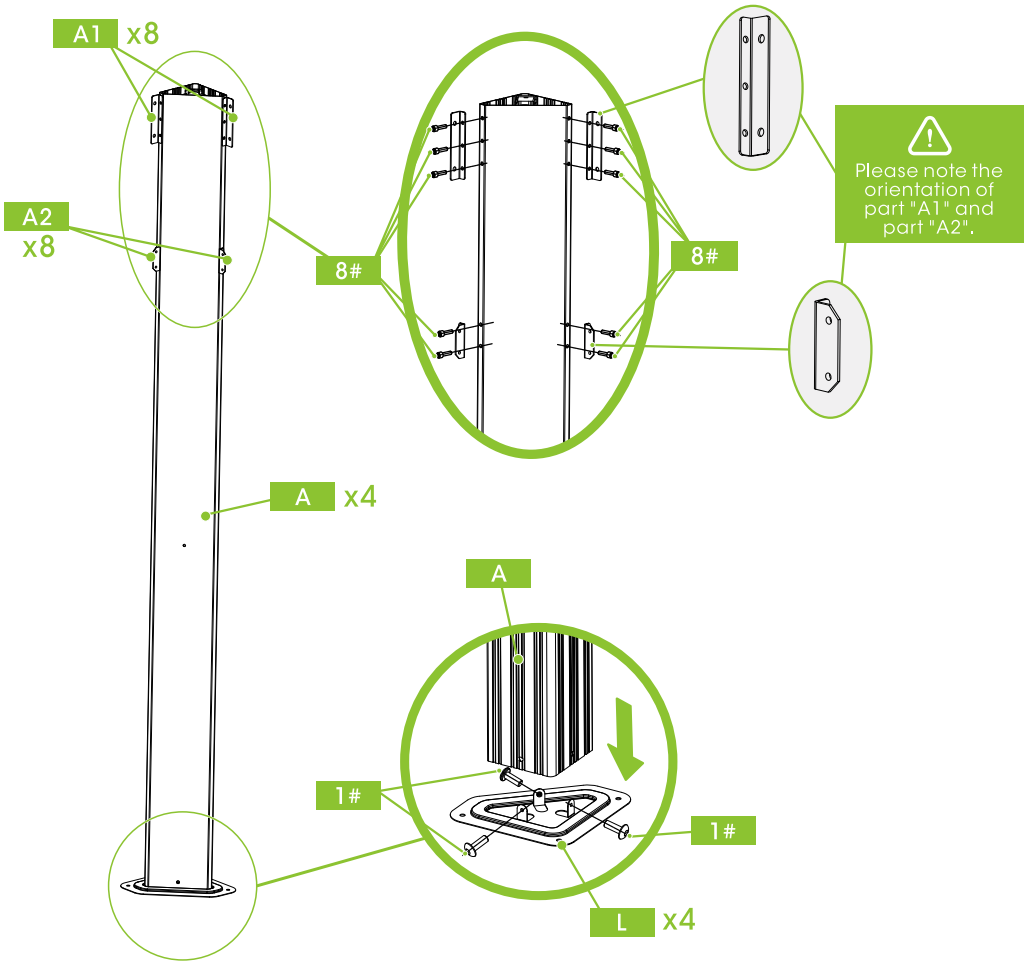





Notice: Repeat the above steps to complete the connection of the remaining 3 pairs of components.

PART	NO.	QTY.	PART	NO.	QTY.
	A	4		L	4
	A1	8		1#	12
	A2	8		8#	40

PRODUCT ASSEMBLY

- 2** Attach part "B1" to the top left and right of part "B" using four "1#" screws. Place part "B" on the top of part "L1" and secure it with four "1#" screws.

PART	NO.	QTY.
	B	2
	B1	4
	L1	2
	1#	16

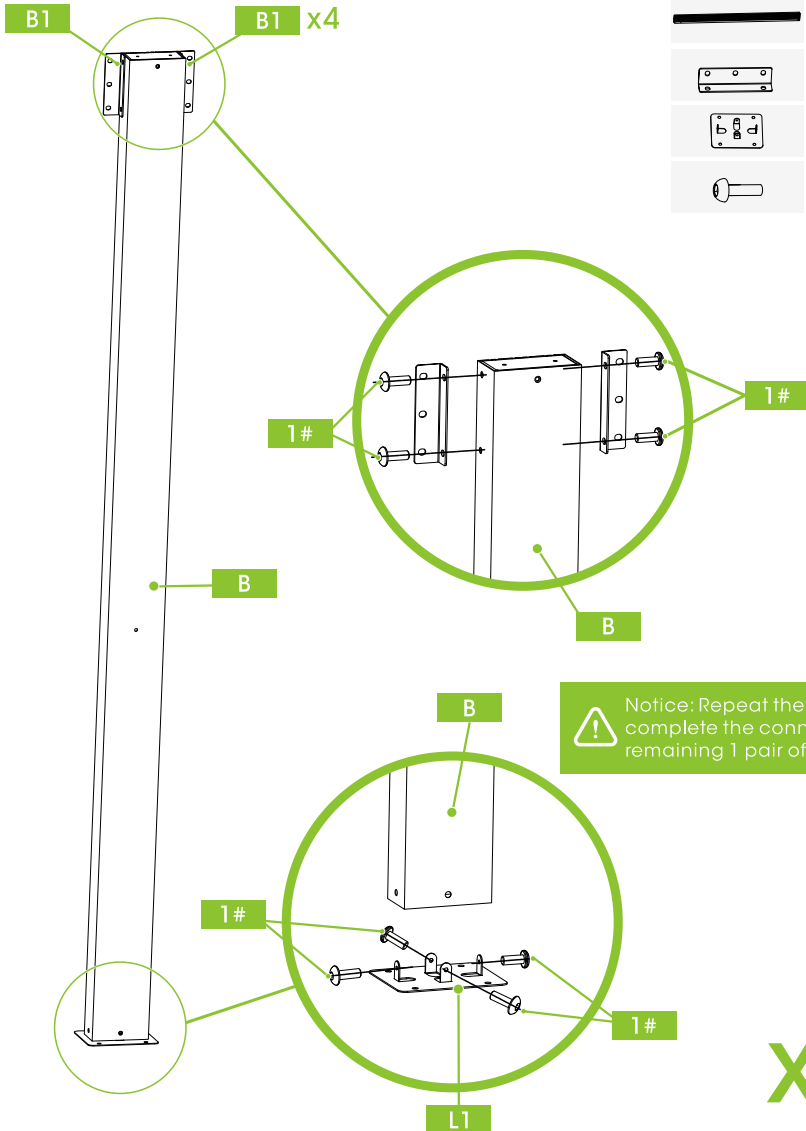

PRODUCT ASSEMBLY

- 3** Attach part "F" to part "D" and part "E" and secure it with six "1#" screws to the lower edge of part "D/E".

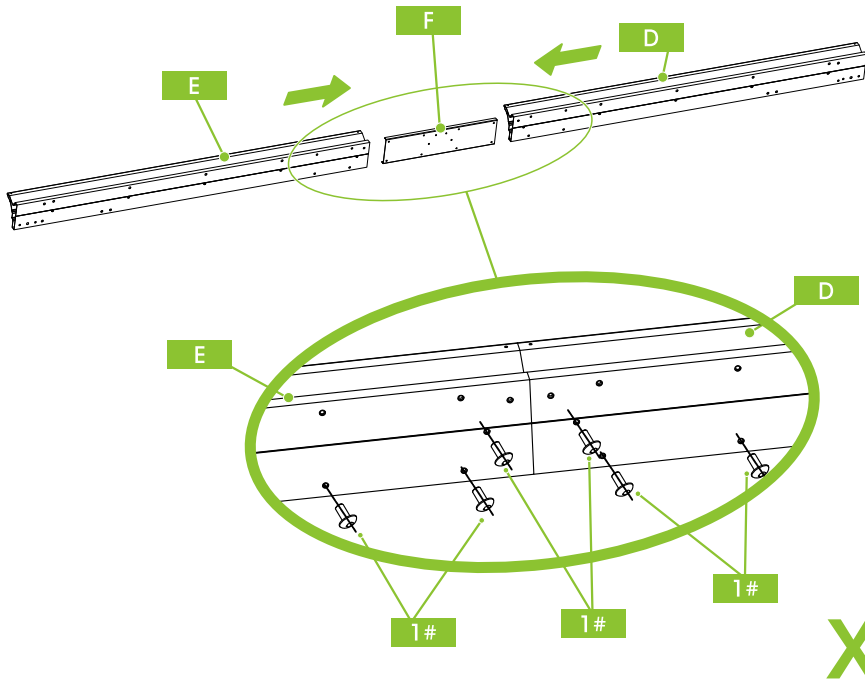

Notice: Repeat the above steps to complete the installation of the other pair of components.

PART	NO.	QTY.
	D	2
	E	2
	F	2
	1#	12

PRODUCT ASSEMBLY

4 Place 2 parts "F" in the middle of parts "E", "C" and "D" respectively, and use 12 pieces "1#" screws to fix the lower edge of parts "E", "C" and "D".

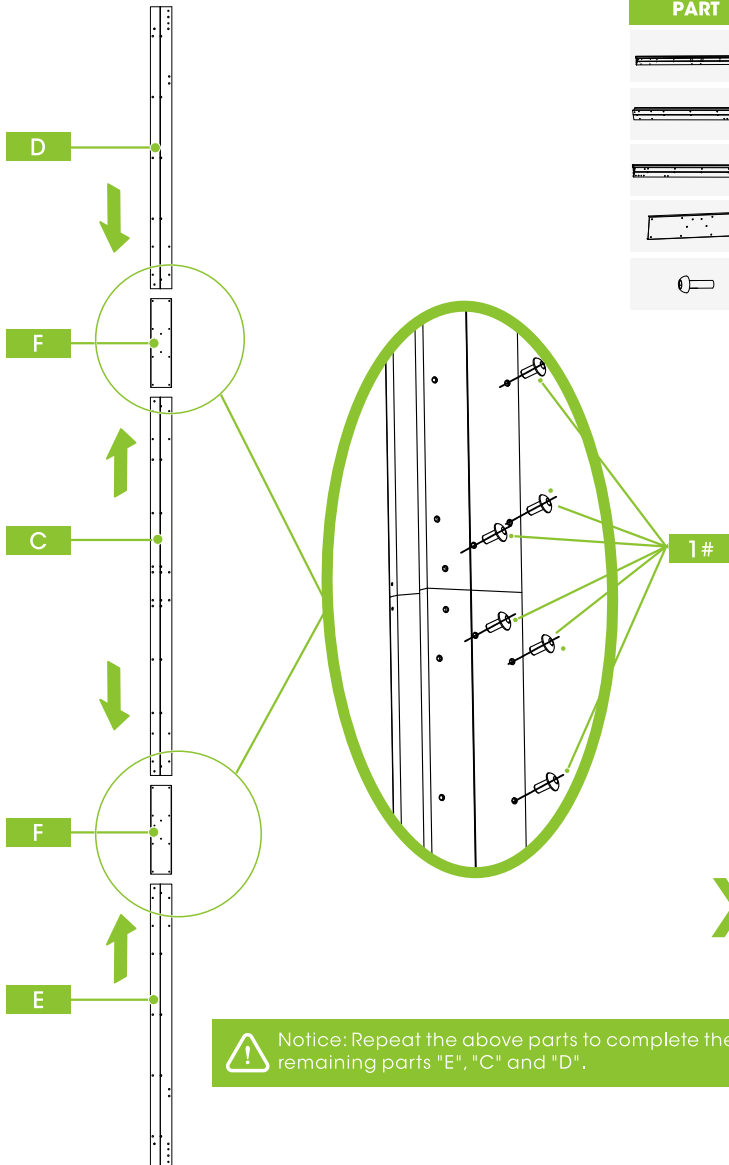

PART	NO.	QTY.
	C	2
	D	2
	E	2
	F	4
	1#	24



Notice: Repeat the above parts to complete the connection of the remaining parts "E", "C" and "D".

PRODUCT ASSEMBLY

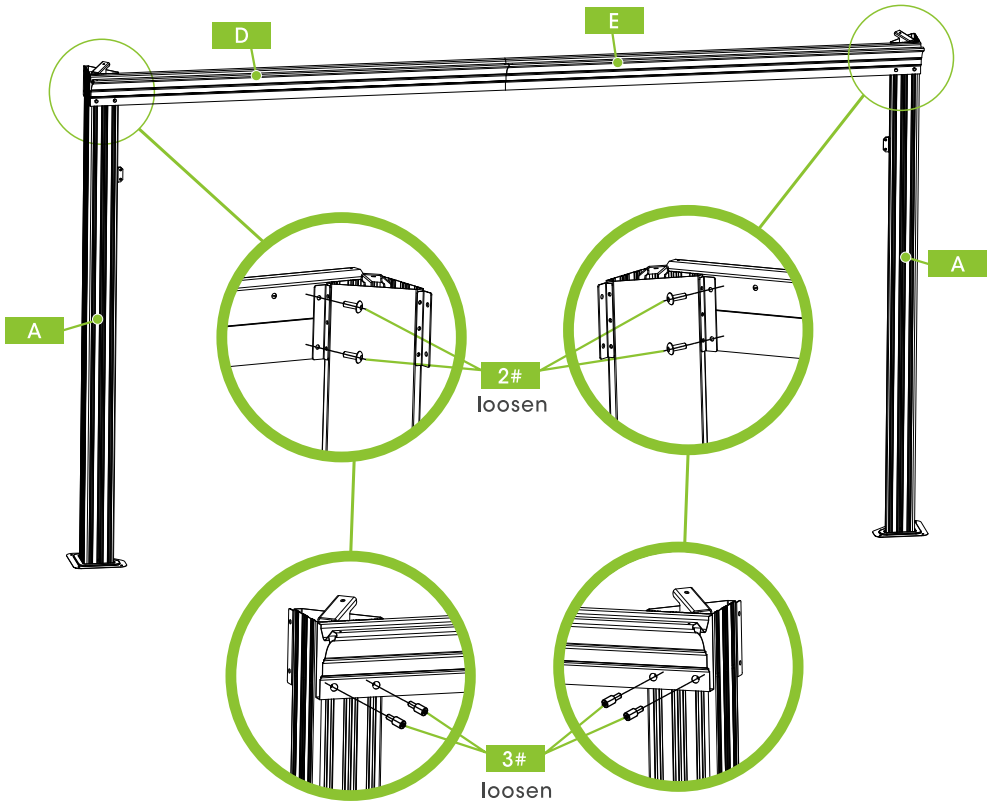

- 5** Place the left and right sides of part "D" and part "E" on the top of part "A", respectively, and use four "2#" screws to fix part "D" and "E". D" and "E" on the inside of the part.



Place the left and right sides of part "D" and part "E" on the top of part "A". Secure part "D" and part "E" with four "2#" screws (on the inside). Use four "3#" screws to secure part "D" and part "E" (on the outside).



Notice: Repeat the above steps to complete the connection of the remaining part "D" and part "E" to part "A".



PART	NO.	QTY.
	2#	8
	3#	8

x2

PRODUCT ASSEMBLY

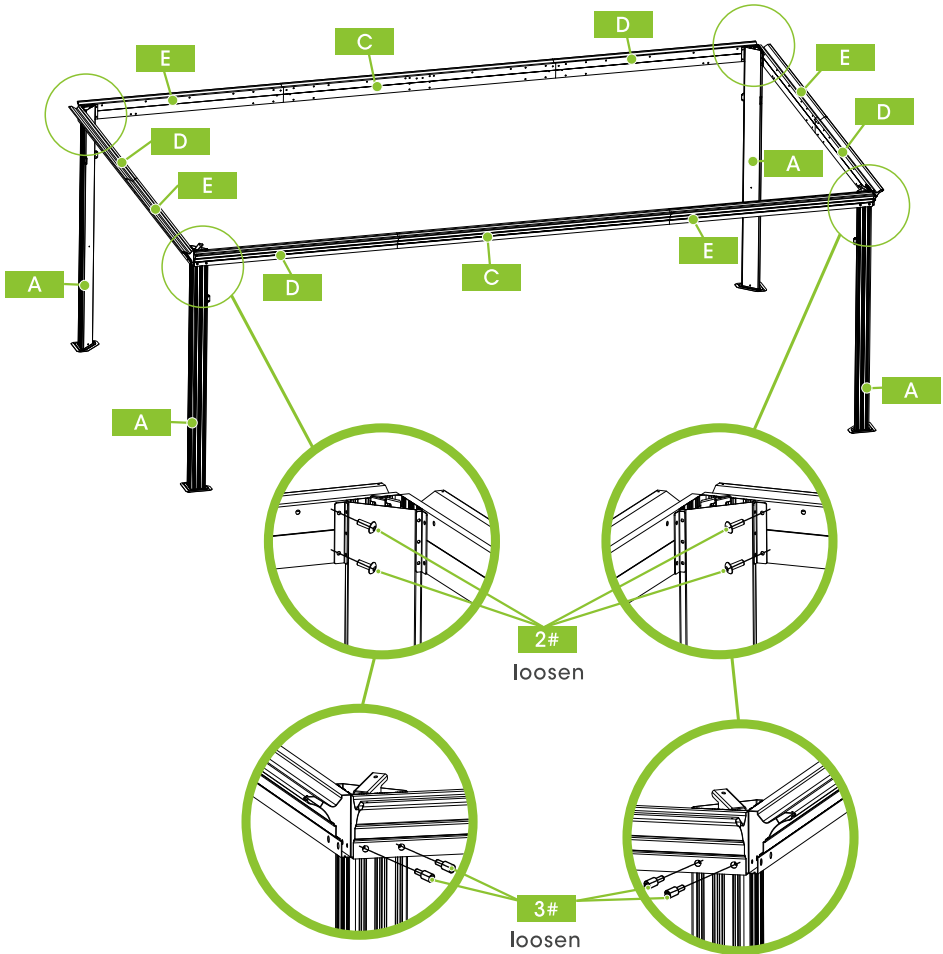
- 6** Place the left and right sides of part "E" and part "D" on the top of part "A", and secure the inner side with eight "2#" screws and the outer side with eight "3#" screws.







PART	NO.	QTY.
	2#	8
	3#	8

PRODUCT ASSEMBLY

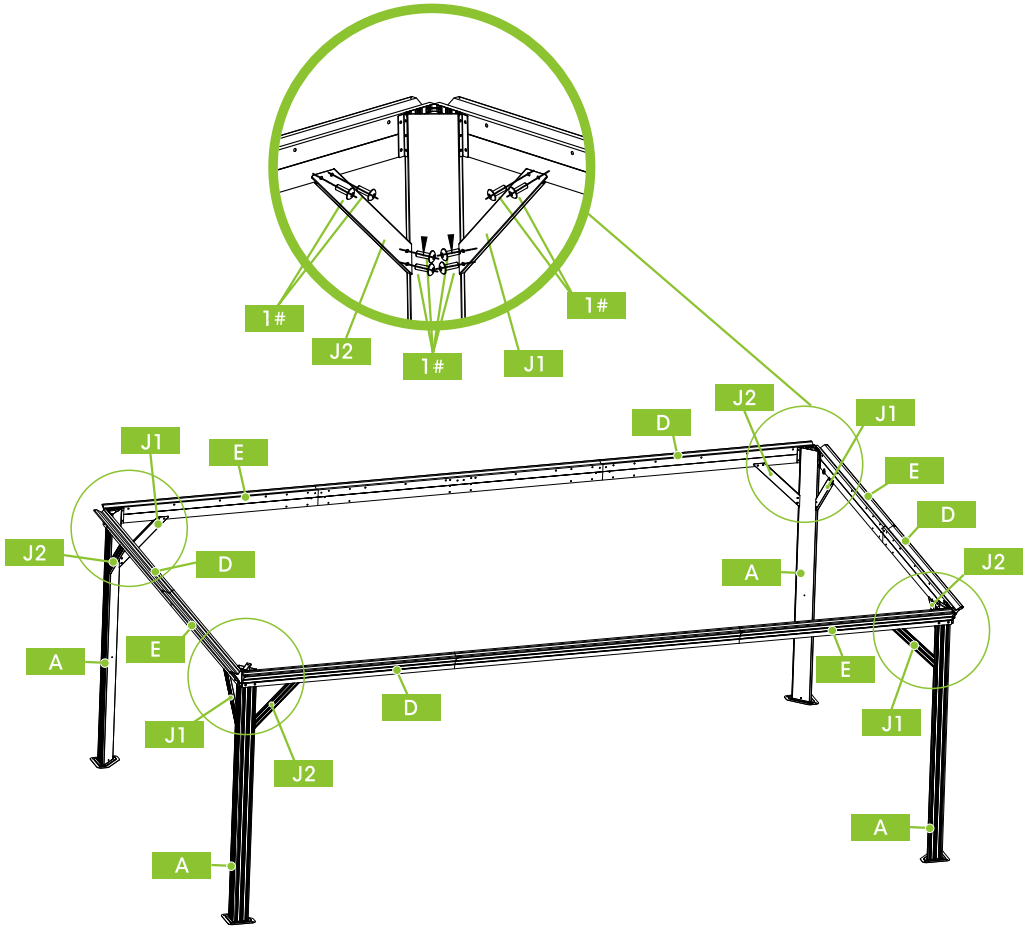
7 Place part "J1" on the right side of the top of part "A" and secure it with 16 "1#" screws.

Place part "J2" on the left side of the top of part "A" and secure it with 16 "1#" screws.







PART	NO.	QTY.
	J1	4
	J2	4
	1#	32

PRODUCT ASSEMBLY

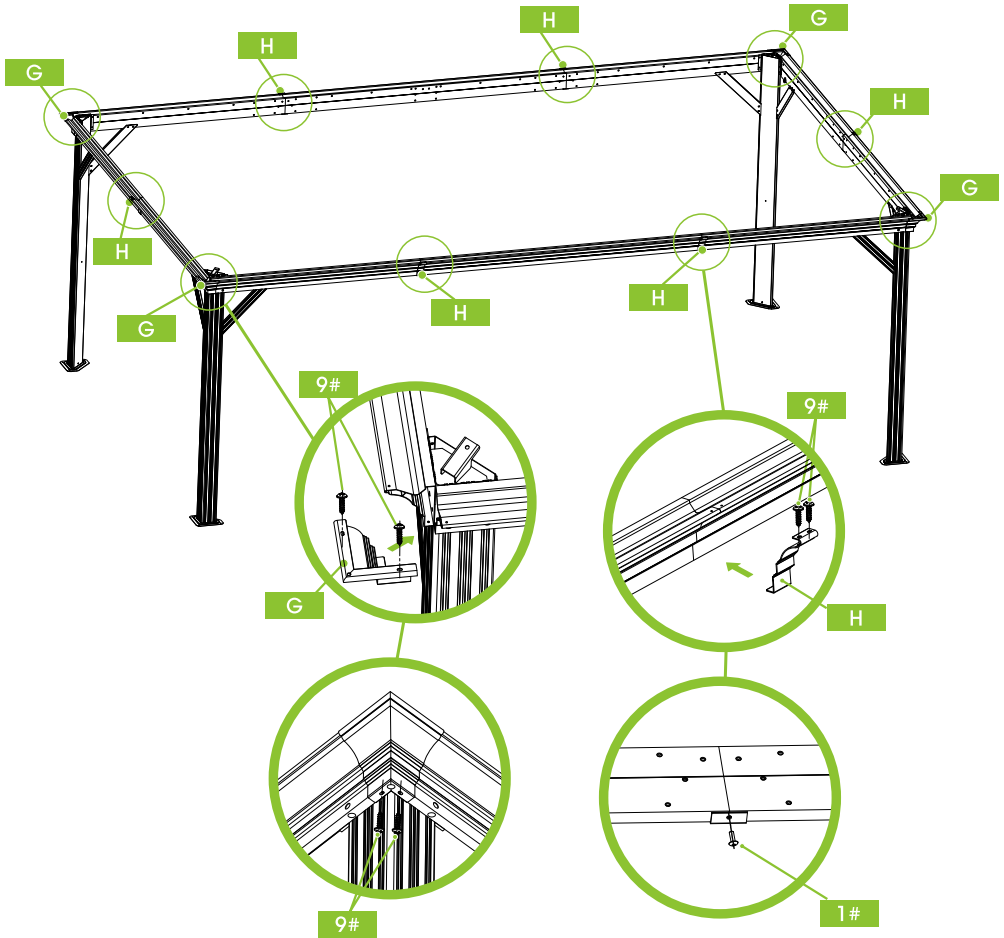
8

Place part "G" in the four corners and secure it with 16 "9#" screws.
Place part "H" in the position shown and secure part "H" with 12 "9#" and 6 "1#" screws.



PART	NO.	QTY.
	G	4
	H	6
	9#	28
	1#	6

PRODUCT ASSEMBLY

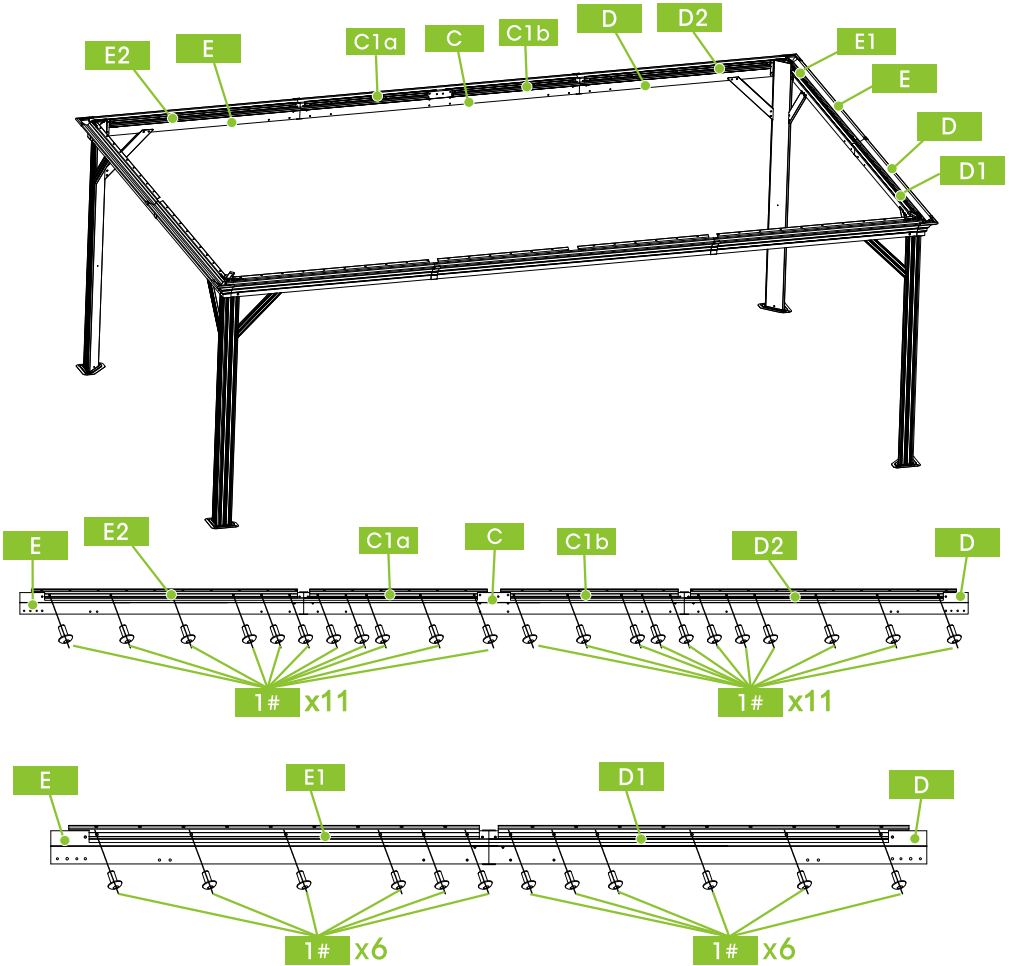

1. Place the "E2" and "D2" components on the top of the inside of the "ECD" assembly and secure them with 11 "1#" screws each.
2. Place the "E1" and "D1" components on the top of the inside of the "ED" assembly and secure them with 6 "1#" screws each.



PART	NO.	QTY.	PART	NO.	QTY.	PART	NO.	QTY.
	C1a	2		D2	2		1#	68
	C1b	2		E1	2			
	D1	2		E2	2			

PRODUCT ASSEMBLY

10 After installa part "4#", Place 12 parts "S1" in the connection

PART	NO.	QTY.
	S1	12
	4#	152

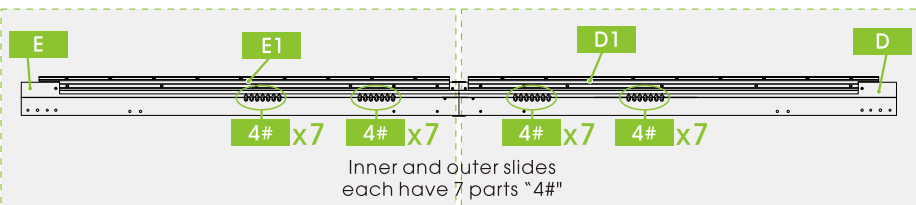
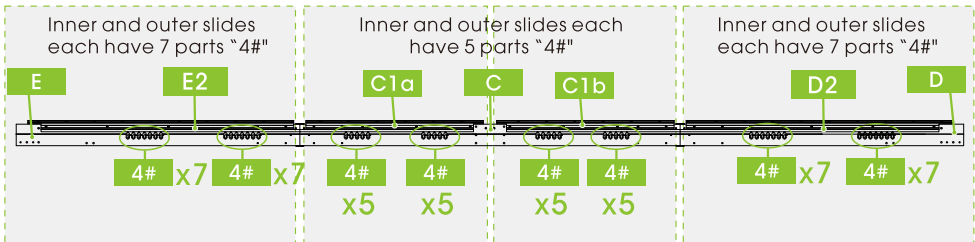
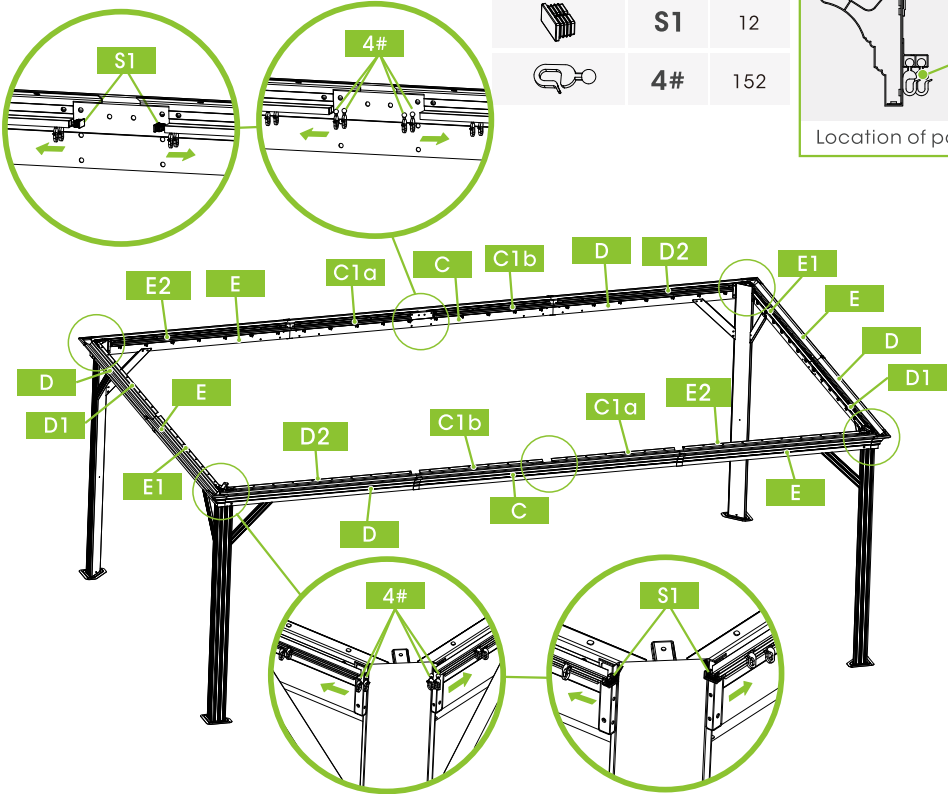
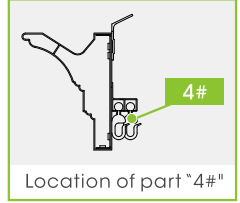

PRODUCT ASSEMBLY

11

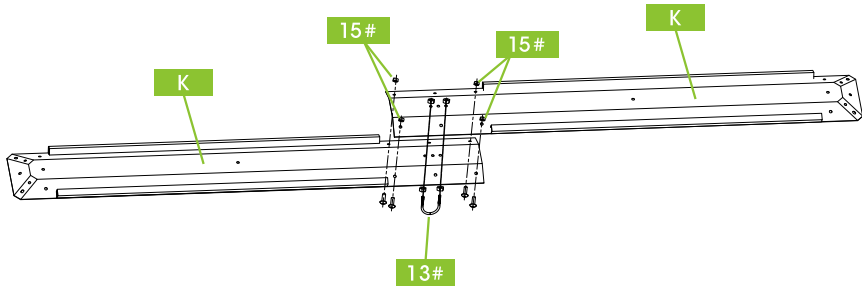

(Do not tighten "13#" fully)

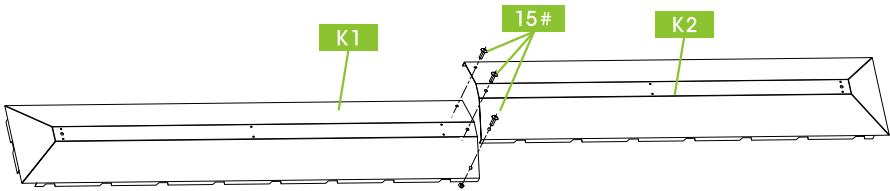



PART	NO.	QTY.
	K	2
	K1	1
	K2	1
	13#	1
	15#	7

PRODUCT ASSEMBLY

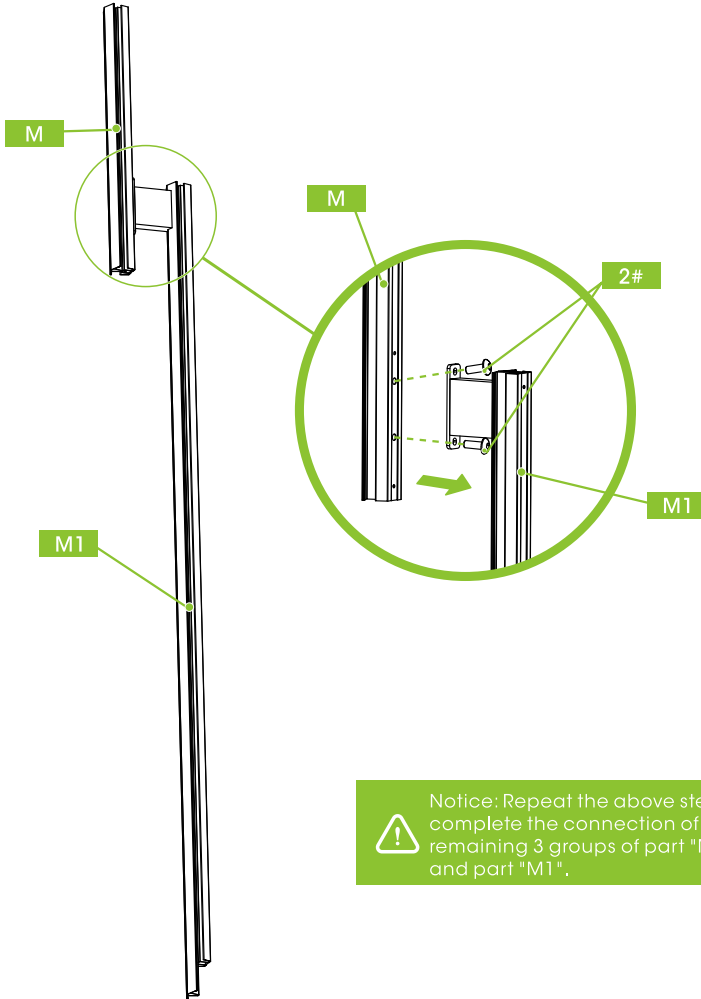
12 Use 8 "2#" screws to connect part "M" to part "M1".



Notice: Repeat the above steps to complete the connection of the remaining 3 groups of part "M" and part "M1".

PART	NO.	QTY.
	M	4
	M1	4
	2#	8

x4

PRODUCT ASSEMBLY

13 Place four parts "M" on both sides of part "K", using eight "1#" screws. Diagram of the position of part "M" and part "M1".

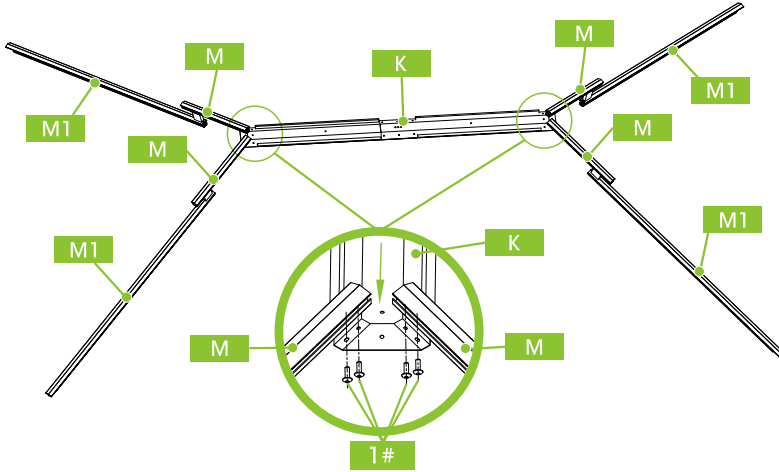

Attach the bottom of part "M1" to the top of part "A", using four "1#" screws.

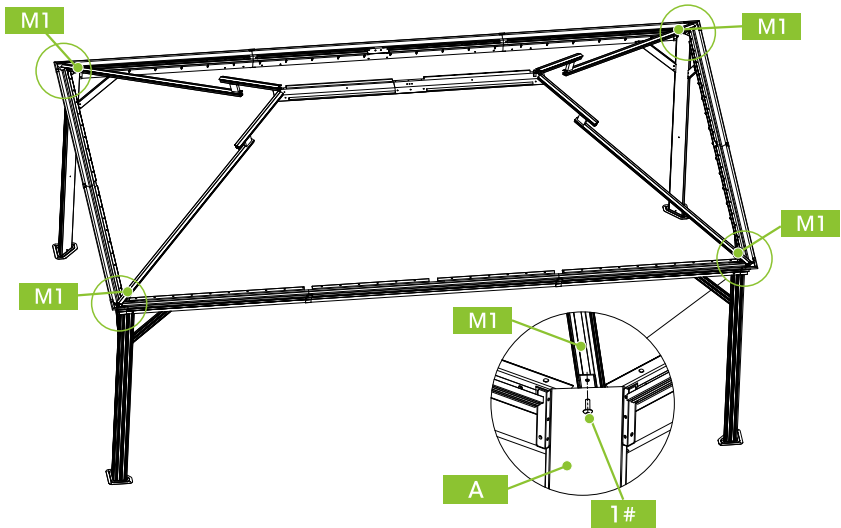

Place the roof frame from the inside of the gazebo and install it with the frame on one side first and the frame on the other side later.

PART	NO.	QTY.
	1#	12

PRODUCT ASSEMBLY

14 Place the top of part "B" in the middle of part "C" and secure it with 12 "2#" screws.

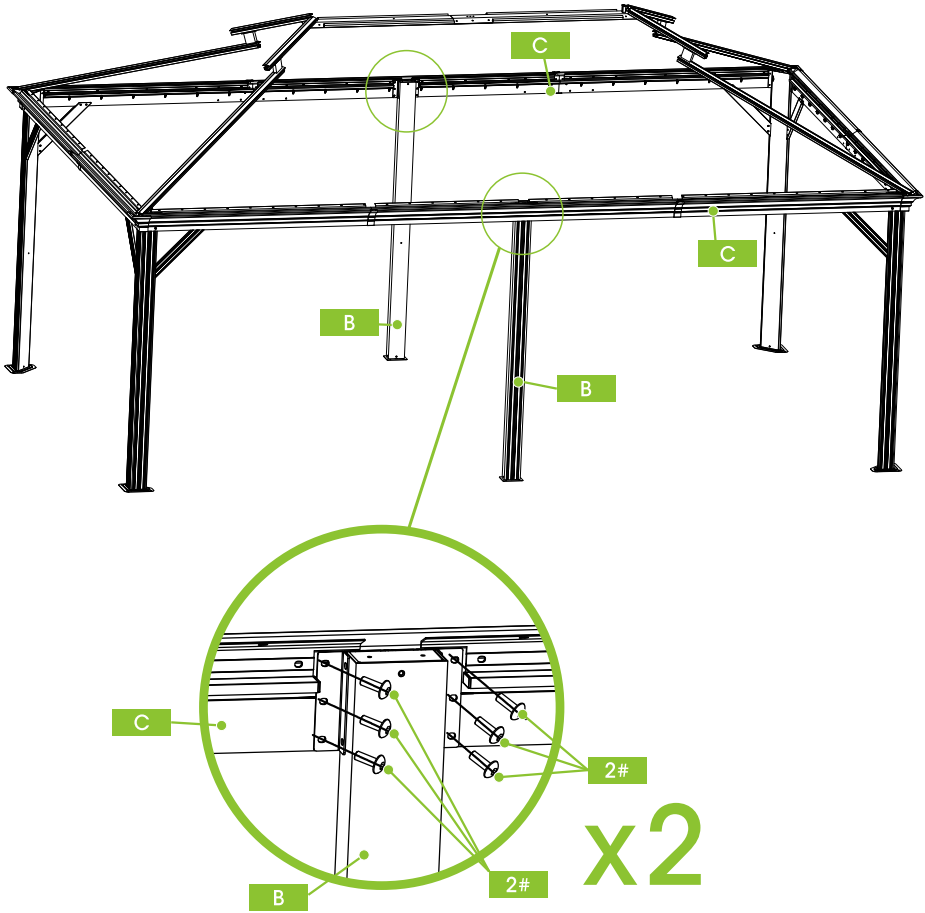

! Notice: Repeat the above steps to complete the installation of the remaining part "B".

PART	NO.	QTY.
	2#	12



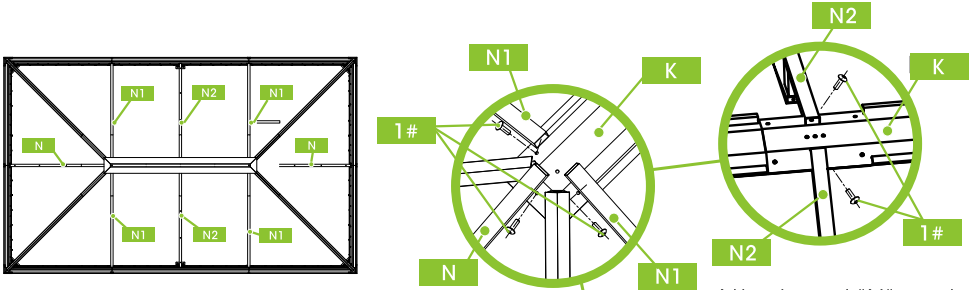

PRODUCT ASSEMBLY

15 The positions of part "N", part "N1" and part "N2" are shown in the figure below.

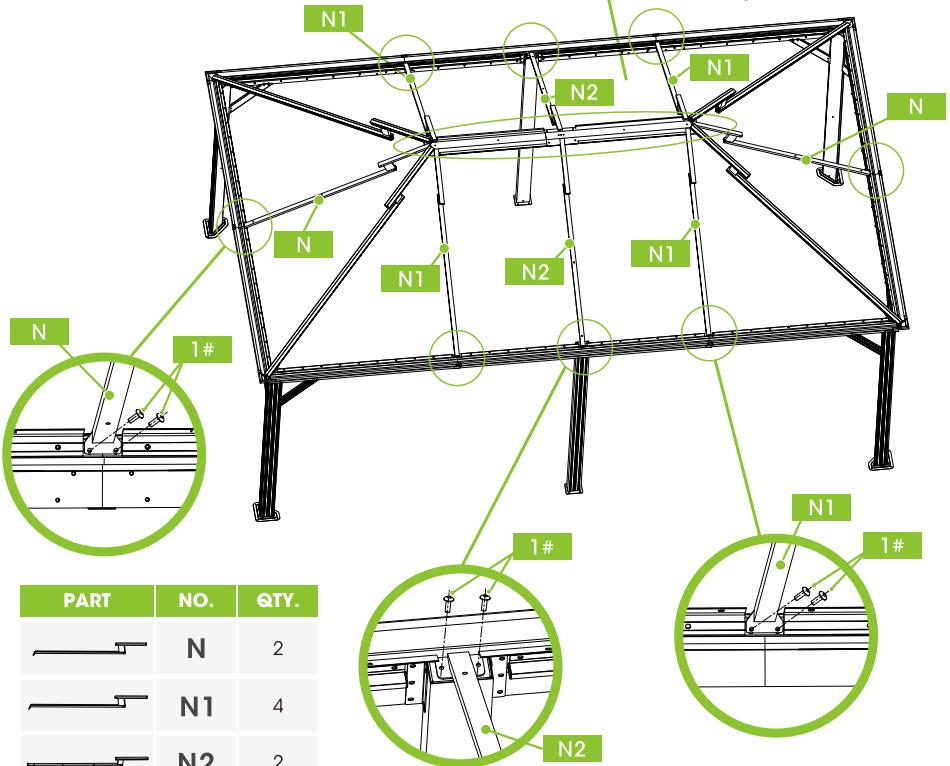

Attach part "N", part "N1" and part "N2" to the top frame using eight "1#" screws.





PART	NO.	QTY.
	N	2
	N1	4
	N2	2
	1#	24

Use 16 "1#" screws to attach part "N", part "N1" and part "N2" to the bottom frame.

PRODUCT ASSEMBLY

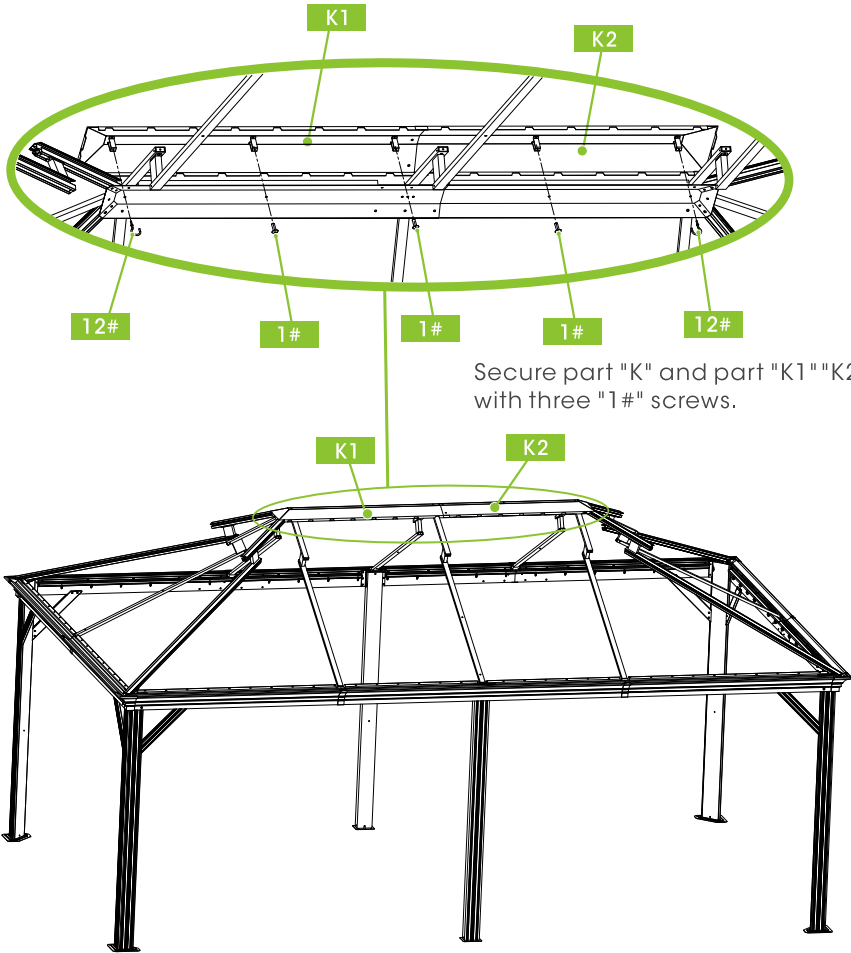
- 16** Place part "K1""K2" on the top of part "K". Use two "12#" screws to fix the sides of part "K" and tighten the "13#" screws in the middle.



PART	NO.	QTY.
	1#	3
	12#	2

PRODUCT ASSEMBLY

- 17** The positions of part "P", part "Q1" and part "Q2" are shown below. Use six "1#" screws to secure part "P", part "Q1" and part "Q2", and place part "R" in the four corners, using the "1#" screws.

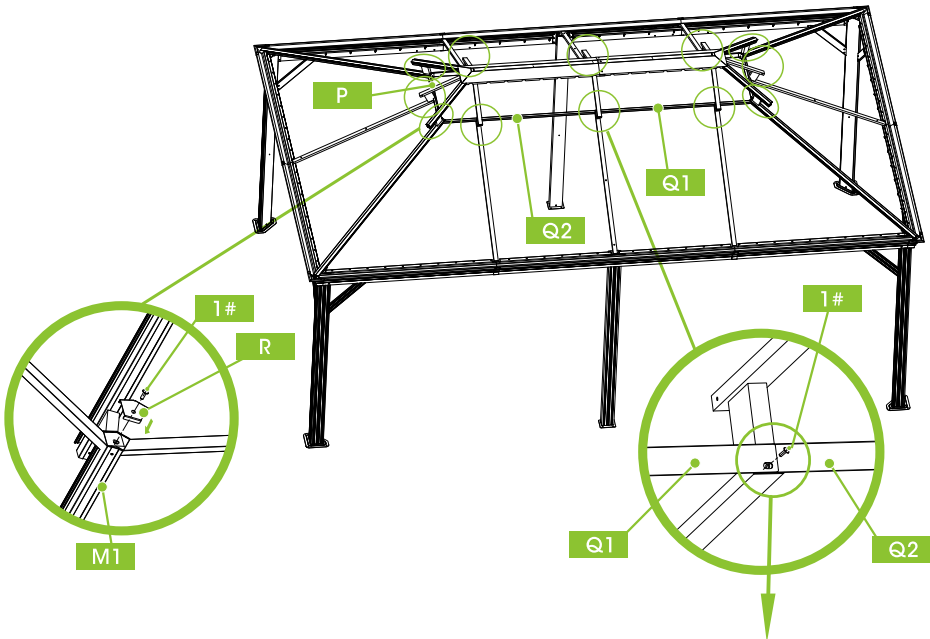
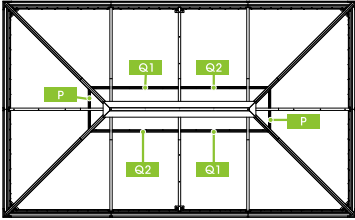

! Notice: Do not tighten the "1#" screw, tighten it after you have finished installing the roof.

PART	NO.	QTY.	PART	NO.	QTY.
	P	2		R	4
	Q1	2		1#	6
	Q2	2			

PRODUCT ASSEMBLY

18 The positions of part "P1", part "Q3", part "Q4", and part "Q5" are shown below.

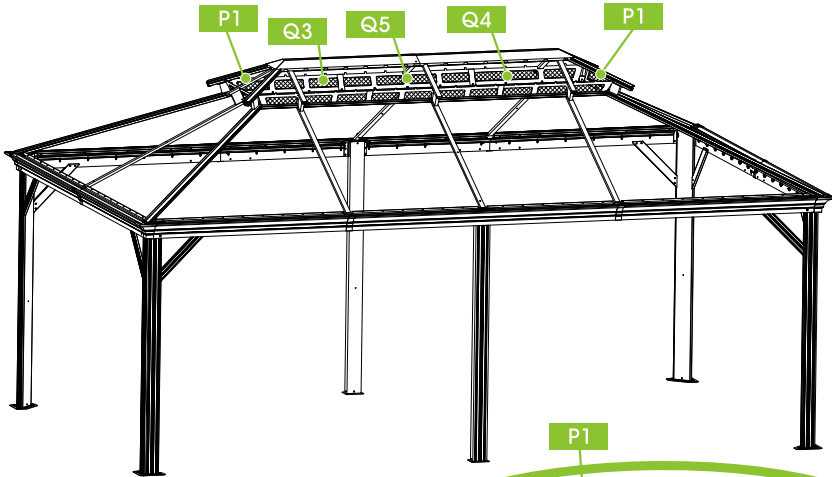

Loosen the "1#" screw and place the part "P1" in the position shown in the figure, and fix it with two "11#" screws.

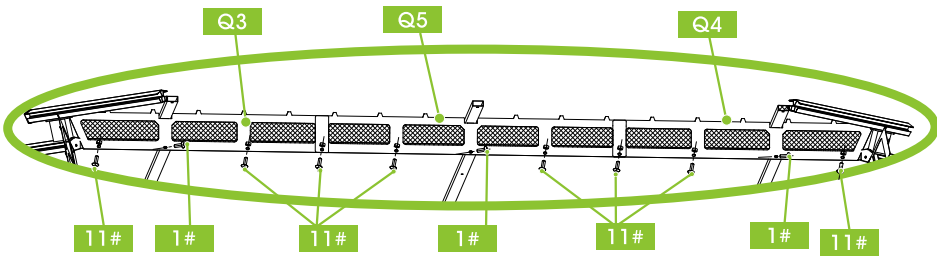
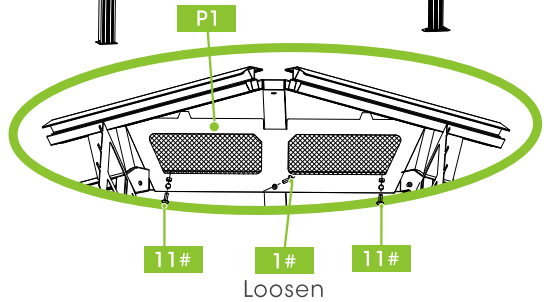





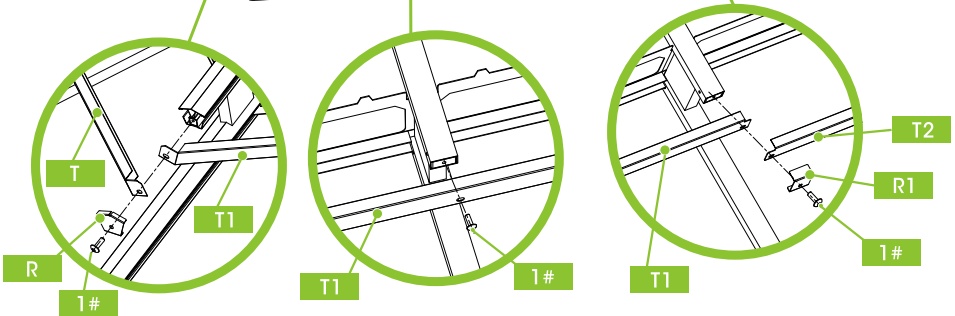
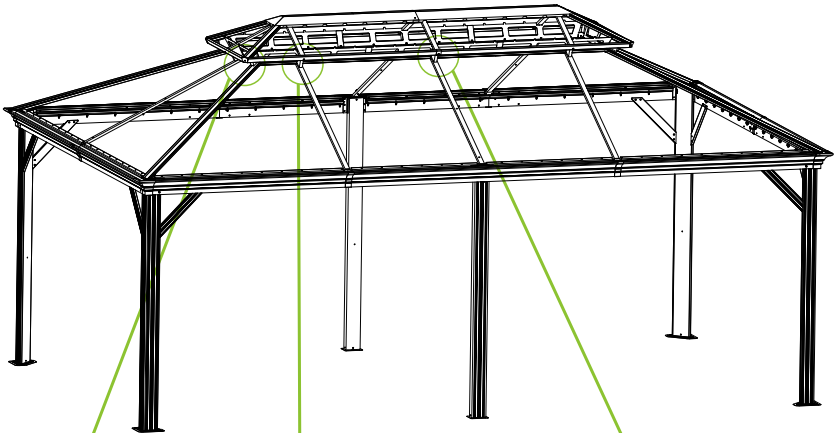
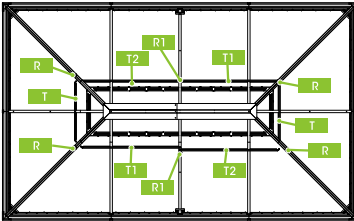

Loosen the "1#" screw, place part "Q3", part "Q5" and part "Q4" in the position shown, and use 8 Use 8 screws "11#" and 3 screws "1#" to fix them.

PART	NO.	QTY.	PART	NO.	QTY.
	P1	2		Q5	2
	Q3	2		1#	6
	Q4	2		11#	20

PRODUCT ASSEMBLY

19 The positions of part "T", part "T1", part "T2", part "R", and part "R1" are shown below. Install part "T" and part "T1" and part "T2" with twelve "1#" screws, install part "R1" to the connection of part "T1" and part "T2", and place part "R" at the four corners.



PART	NO.	QTY.	PART	NO.	QTY.	PART	NO.	QTY.
	1#	12		T1	2		R1	2
	T	2		T2	2		R	4

PRODUCT ASSEMBLY







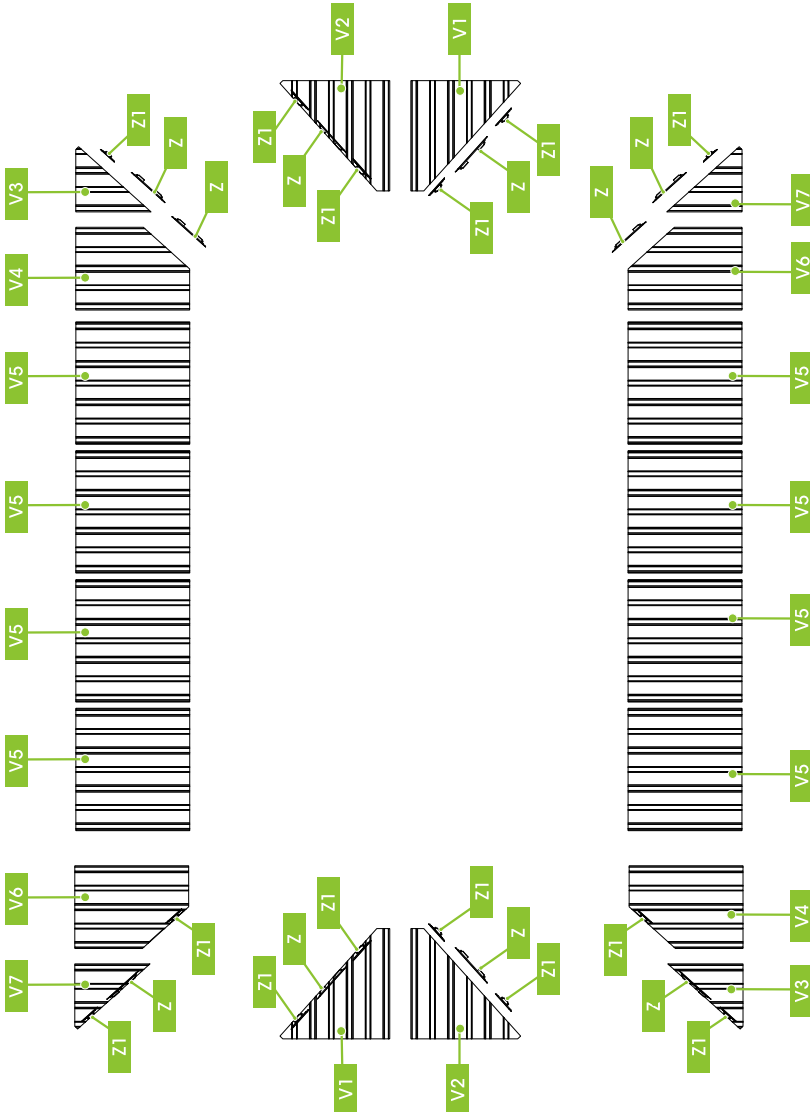

20

Diagram of the location of the small roof tiles.



Installation Tips: Part "Z" and part "Z1" serve to shield the sun and water. It may not be easy to install, so if it is not easy to install, you can remove it.



PART									
NO.	V1	V2	V3	V4	V5	V6	V7	Z	Z1
QTY.	2	2	2	2	8	2	2	8	16

PRODUCT ASSEMBLY

21 The positions of part "V3", part "V4", part "V5", part "V6" and part "V7" are shown below. Installation Tips: Part "V3", part "V4", part "V5", part "V6" and part "V7" are added to the roof from left to right.

Please make sure the holes are aligned.

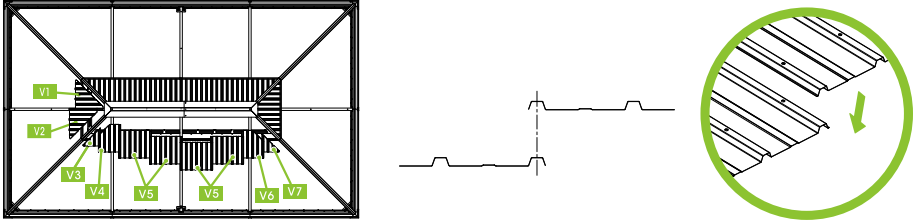

Loosen the four corner parts "R" and six screws "1#", and place the parts "V1" and "V2" on both sides of the roof. Insert part "T", place part "R" and fix it with 6 screws "1#".

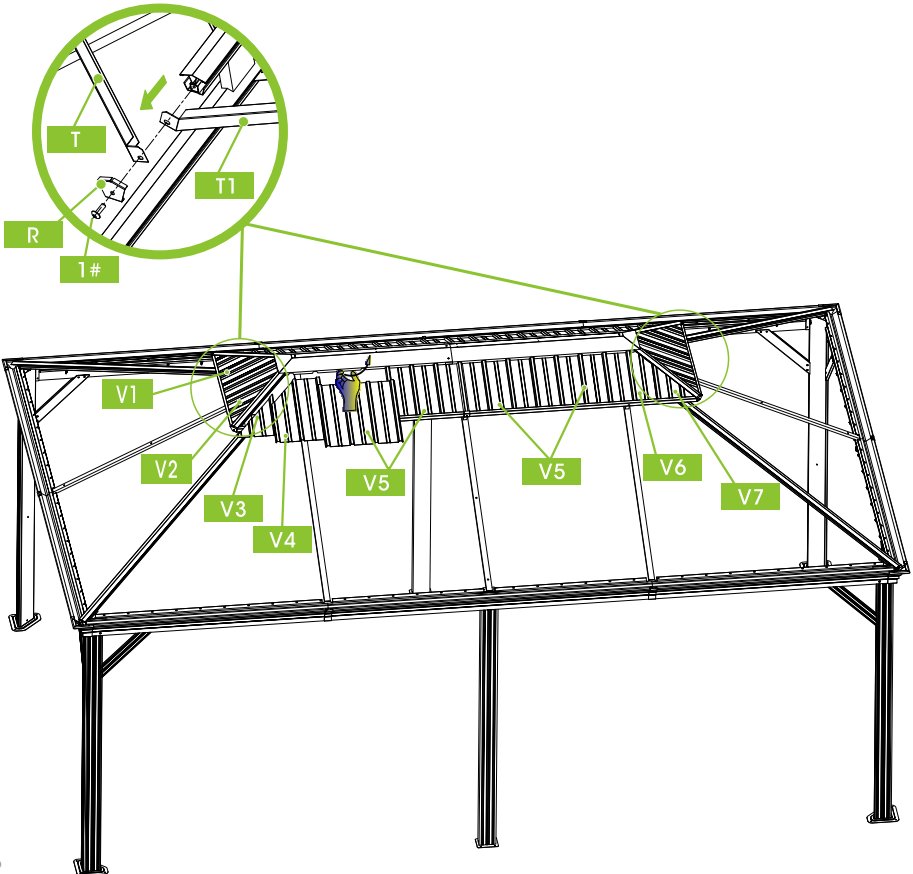

PRODUCT ASSEMBLY

22

Remark: Tight the screw "1#" and "12#"

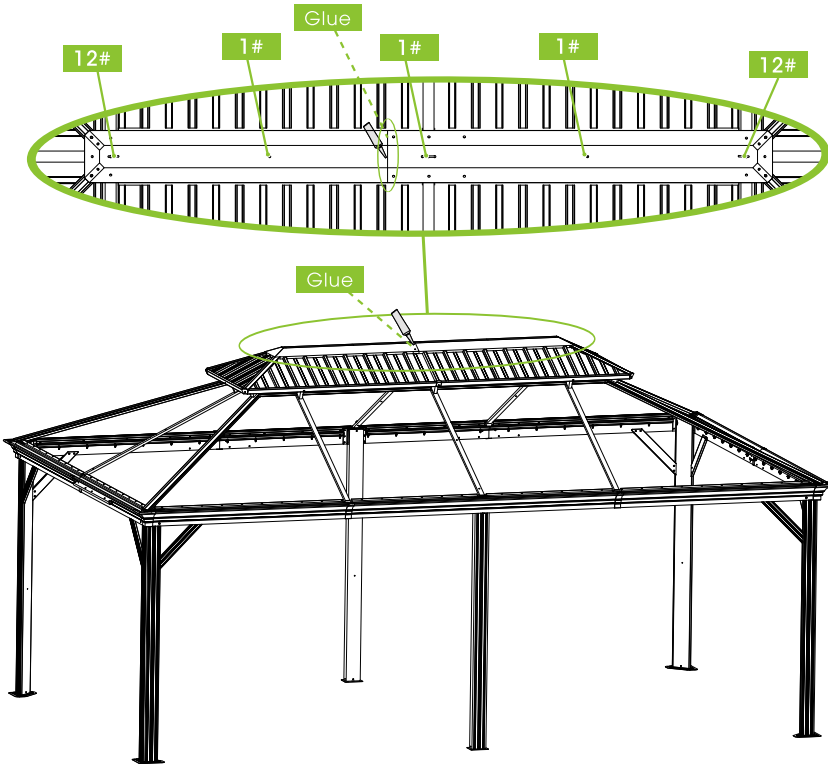

PRODUCT ASSEMBLY

23

The locations of part "U1", part "U2" and part "U3" are shown in the diagram below.
 Place part "U4" at the four corners and secure it to part "M1" with 12 "1#" screws.
 Place the part "U5" in the remaining position and secure it with 24 "1#" screws.

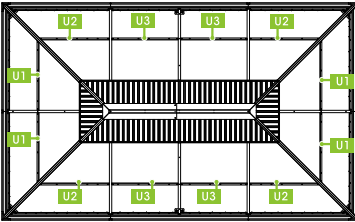

PART	NO.	QTY.	PART	NO.	QTY.
	U1	4		U4	4
	U2	4		U5	8
	U3	4		1#	36

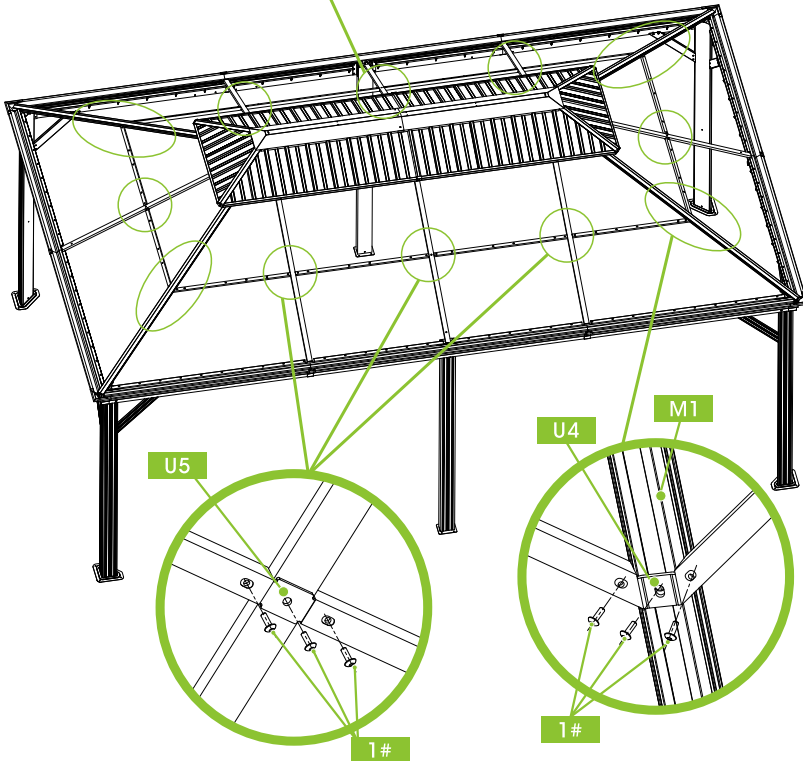
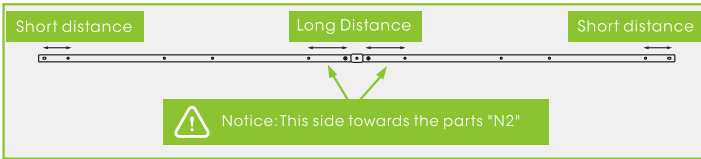

PRODUCT ASSEMBLY

24 The positions of part "W1", part "W2", part "W3", part "W4", part "W5", part "W6", part "W7", and part "W8" are shown below.



Notice: The main function of the component "Z" is to block the entry of sunlight and water. To facilitate installation, the part "Z" can be removed, which will sacrifice a certain amount of sun and rain protection.

PART									
NO.	W1	W2	W3	W4	W5	W6	W7	W8	Z
QTY.	2	2	2	2	2	2	2	2	32

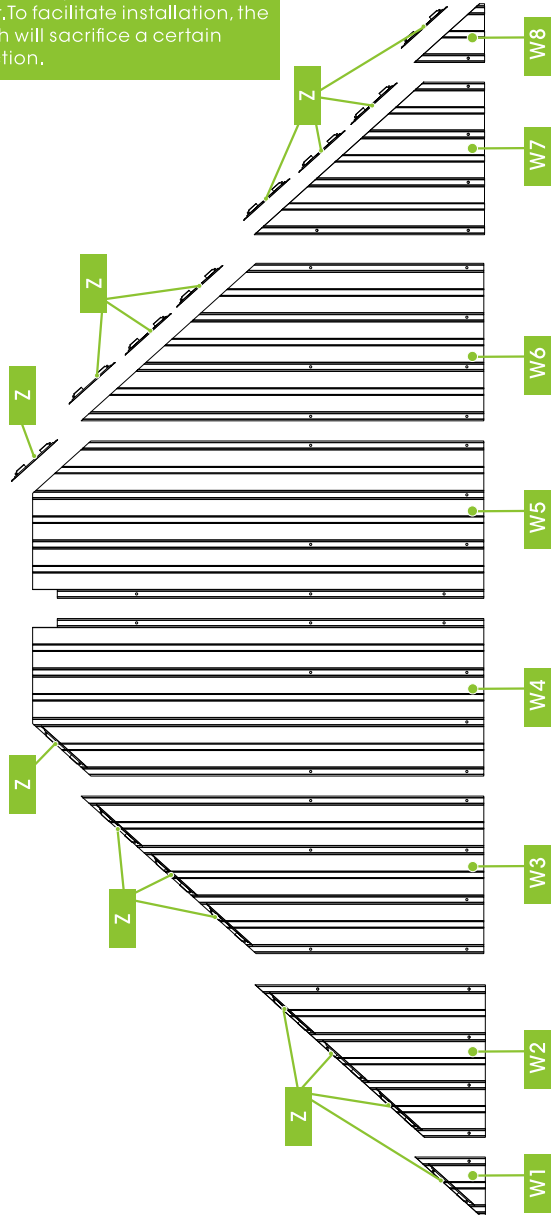

PRODUCT ASSEMBLY

26

The positions of part "W1", part "W2", part "W3", part "W4", part "W5", part "W6", part "W7", and part "W8" are shown below.

The positions of part "X1", part "X2", part "X3", part "X4", part "X5", part "X6", part "X7", part "X8", part "X9", part "X10", part "X11", and part "X12" are shown below.

 Notice: Install the parts in order from left to right.

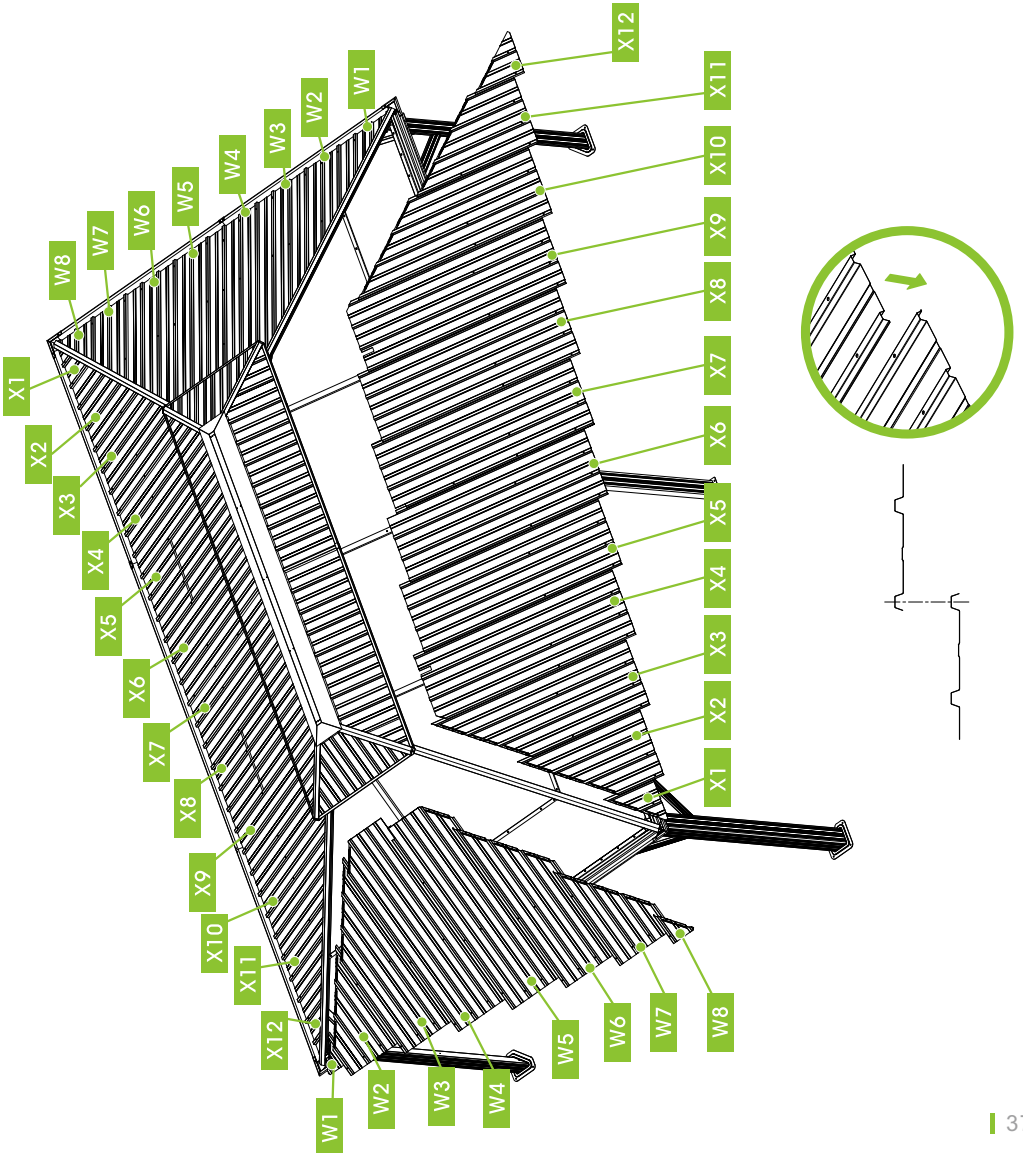

PRODUCT ASSEMBLY

27 Installation Tips:

Roofs are installed from left to right.

Place the part "S" under the circle in the figure

Please do not tighten the screws during installation, and tighten them after finishing the installation.

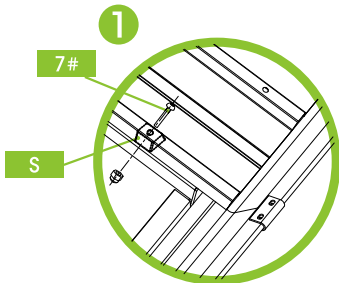
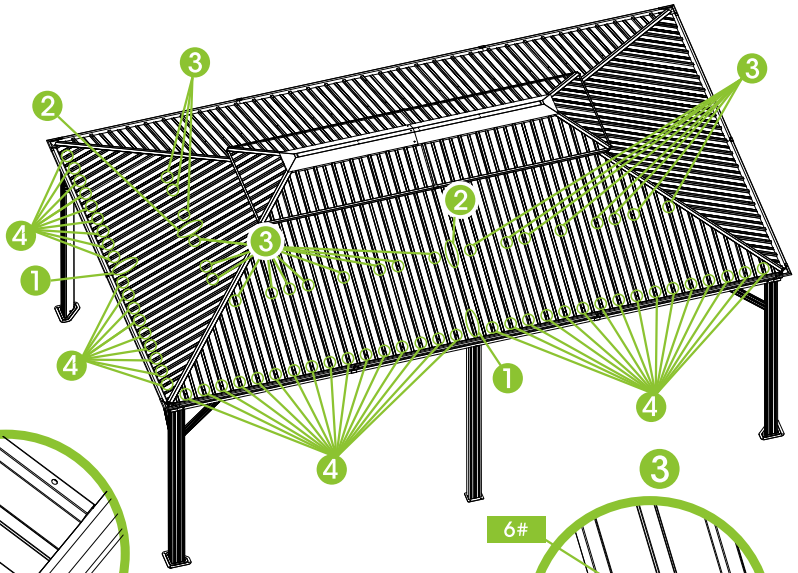
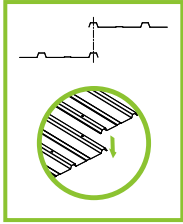

In the position "1" in the picture, use four "7#" screws to fix.

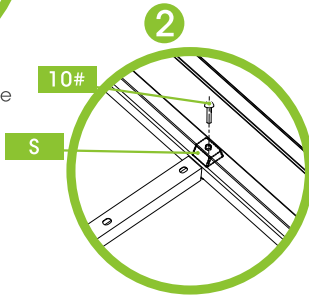

In position "2" in the figure, use four "10#" screws to fix.

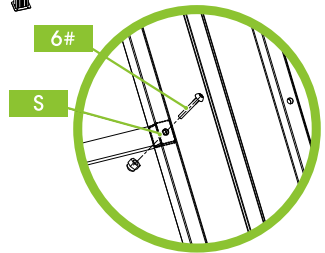

In the position "3" in the picture, use forty-four "6#" screws to fix.

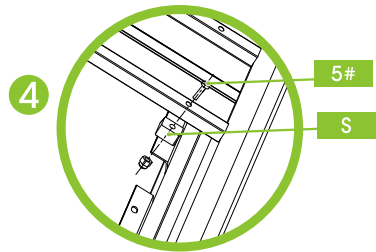

In the position "4" in the picture, use one hundred "5#" screws to fix.

PART	NO.	QTY.
	S	152
	5#	100
	7#	4

PART	NO.	QTY.
	6#	44
	10#	4

PRODUCT ASSEMBLY

28

The positions of part "Ya" and part "Y1a" are shown in the figure below
Place part "Ya" and part "Y1a" on the inside of the track.

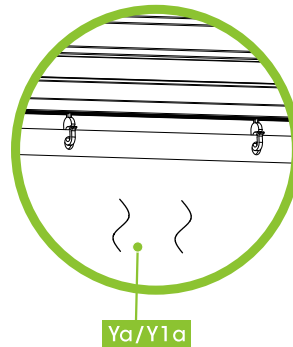
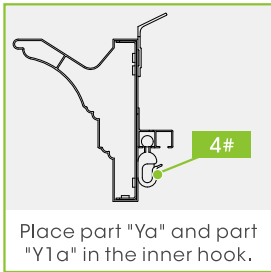
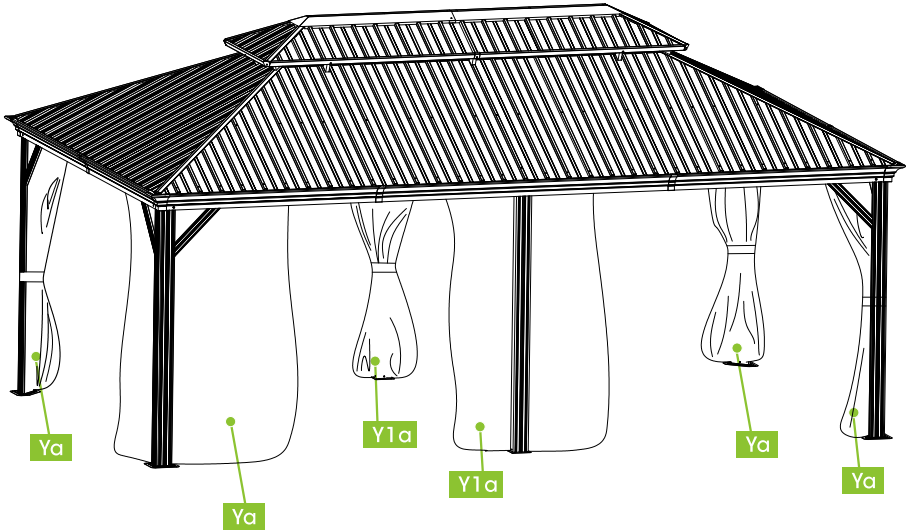



PART	NO.	QTY.
	Ya	4
	Y1a	2

PRODUCT ASSEMBLY

29

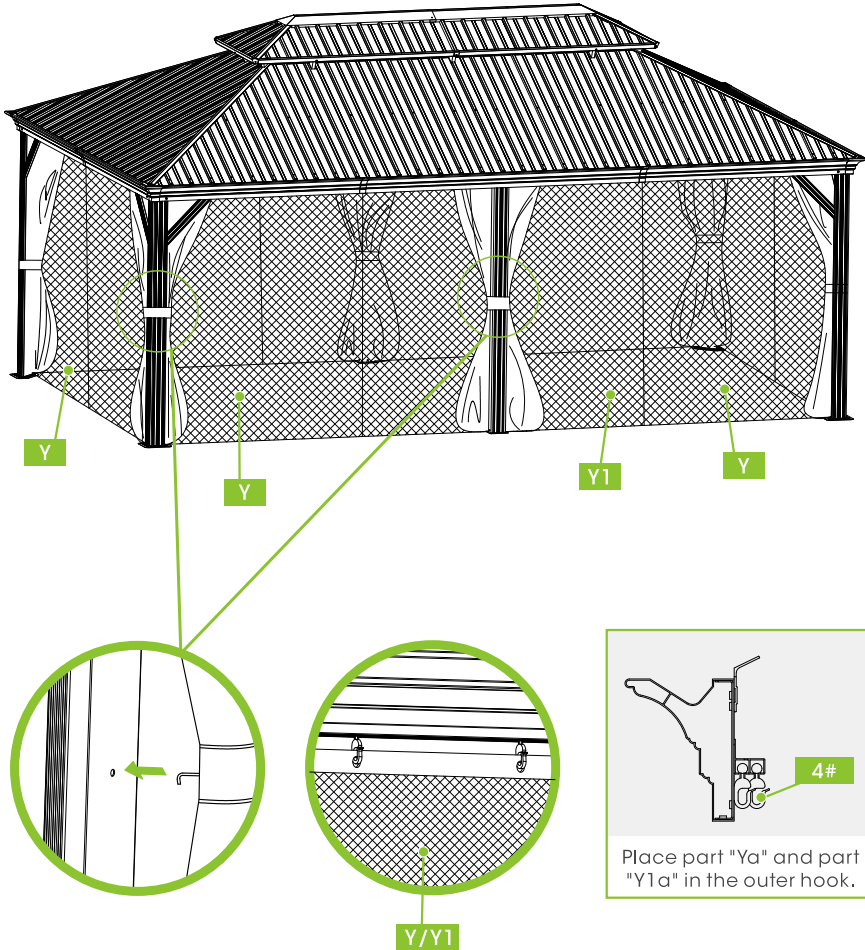
The position of part "Y" and part "Y1" is shown in the following diagram.
Place part "Y" and part "Y1" on the outside of the track.
Connect the curtain hooks to the middle holes of the four corner posts.



PART	NO.	QTY.
	Y	4
	Y1	2

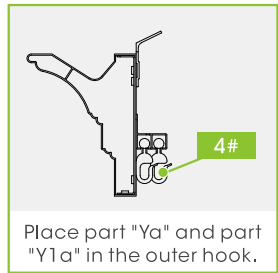

PRODUCT ASSEMBLY

30 Use twenty "14#" screws to fix the gazebo to the ground

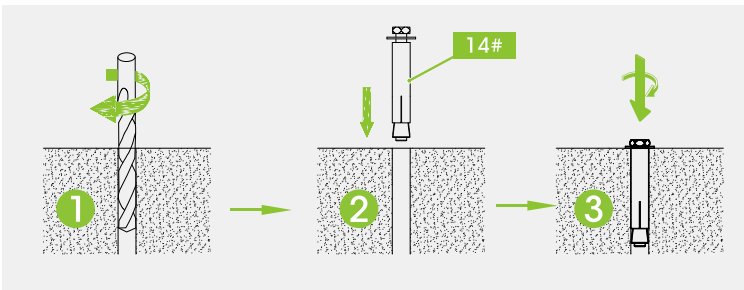
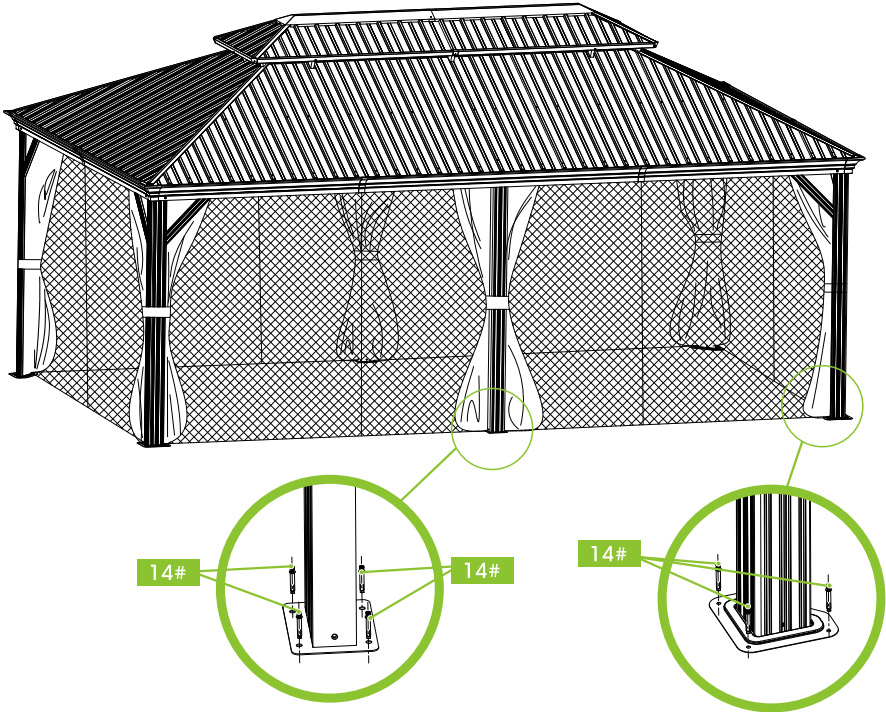

PART	NO.	QTY.
	14#	20

PRODUCT ASSEMBLY

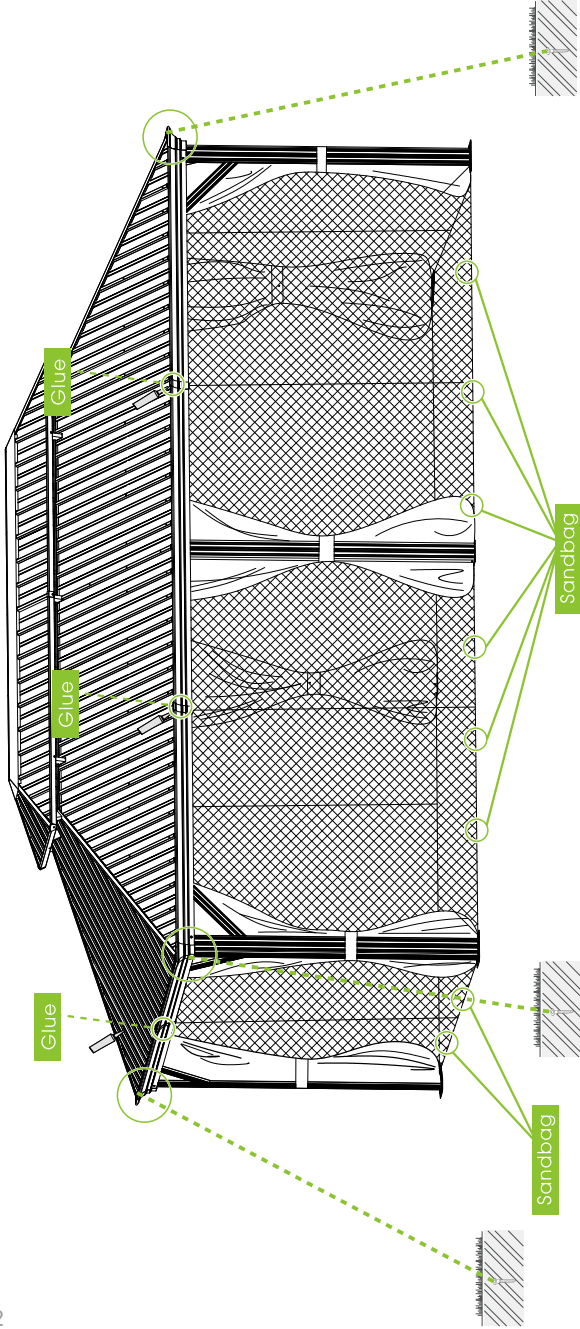

Suggestions for use

1. To avoid blowing the gazebo over in windy weather, please use a rope to pull at the four corners.
2. If you encounter high winds during use, you can place a heavy object in the hole at the bottom of the curtain to prevent it from fluttering.
3. Leakage may be encountered at the junction of the eaves, please use glass glue for bonding.
4. During heavy snowfall, please clear the snow from the roof in time to prevent it from bending.
5. To prevent water leakage at the joints, please use glue to bond the joints. (Purchase by yourself)

HELP CENTER

Question about your product? We're here to help. Visit us at:

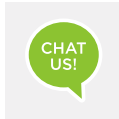

Chat Support



Product Inquiry

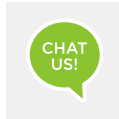

Orders FAQ



Product Assembly



Returns & Refunds

We Stand Behind the Quality of Their Furniture

If you have any issues with your item please let us know! We will always do our best to come up with a solution that you will be happy with.

Please get in touch with our customer service team before returning the product.

And pls do not throw the original box(es) if you have not finished assembling or confirmed no quality issues.

Length of return period:

Items can be returned within 30 days of purchase.

In the meanwhile, everything you purchased from us comes with a one-year warranty.

Who is responsible for the return shipping fee:

We will cover the return shipping fees if:

1. Your item has a manufacturing defect in its materials or workmanship. For example, torn wicker or misaligned screw holes. We will send you a prepaid shipping label after photos are sent.
2. Your item has been damaged in transit. For example, glass is broken or wicker is damaged. We will send you a prepaid shipping label after photos are sent.
3. You receive the wrong box(es) due to a warehouse error. We will send you a prepaid shipping label after photos are sent of the wrong SKU numbers on the outer box(es).
4. One or more boxes are lost in transit. We will send you a prepaid shipping label if you no longer want the item.

*However, we still hope to work with you for a better solution instead of a return. Please don't hesitate to contact our customer service team.

Customer will cover the return shipping fees if:

1. You don't like the product(s) after receiving the box(es).
2. You no longer need the product(s) but you have received the box(es).
3. You buy the product(s) by mistake but you have received the box(es).
4. Order/Shipment cancellation failed and you have received the box(es).

Return Request

In order to get a full refund as described in this return policy, all items must be: (1) In a brand new/unused condition, please provide photos before and after packaging. (2) When returning, all accessories and parts are firmly packed in all original packaging. If your return does not meet the requirements, you may not get a full refund.

When will I be refunded?

The refund is released once the goods have been returned to our warehouse.

What if the product is damaged/defective outside of the valid return period?

We want you to be a happy customer. Please reach out to us by email and we will come up with a solution to make sure you are satisfied.