

WARNING

- * Switch off the main electrical supply from the main fuse box / circuit breaker before installation.
- * Inspect item carefully before attempting to install.
- * If there is any damages or obvious defects, do not install.
- * Item may not be returned once it has been installed.









CARE AND MAINTENANCE

- * To clean the outside of the fixture, use a dry or slightly dampened clean cloth (use clean water, never a solvent) to wipe the surface of the fixture.
- * To clean the inside of the fixture, first disconnect power to the fixture by turning off the circuit breaker or by removing the fuse at the fuse box. Next, use a dry or slightly dampened clean cloth (use clean water, never a solvent) to wipe the interior surface of the fixture.
- * Do not use any cleaners with chemical, solvents or harsh abrasives. Use only a dry soft cloth to dust or wipe carefully.

NOTICE& IMPORTANT SAFETY INSTRUCTIONS

- ** WE RECOMMEND INSTALLATION OF THIS LIGHTING FIXTURE BE DONE BY A LICENSED ELECTRICIAN **
- * Please make sure that you have all parts indicated before you begin assembly of this item
- * This item should be assembled on a soft surface to prevent scratching the finish during assembly
- * To reduce the risk of fire, electrical shock or injury to persons or property, please follow the guideline below for safe use and installation
- *The external flexible cable or cord of this lamp cannot be replaced
If the cord is damaged, the lamp shall be destroyed

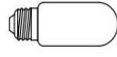
Part List and Hardware List

PIECE	DESCRIPTION	PICTURE	QUANTITY	PIECE	DESCRIPTION	PICTURE	QUANTITY
A	Wire Connector		3X	F	Screwed Ball		2X
B	Mounting Plate		1X	G	Glass Shade		2X
C	Ground Screw		1X	H	Socket ring		2X
D	Mounting Screw		2X	I	Bulb		2X
E	Lamp Body		1X				

Product Dimensions: 4.75"LX X 6"W 20.5"H

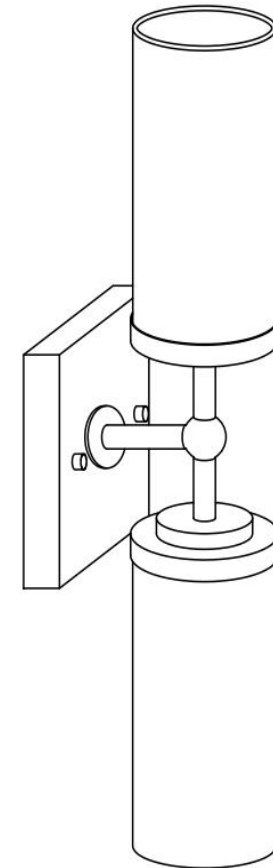

PREPARATION

* Before beginning assembly of product, make sure all parts are present. Compare parts with package contents list and hardware contents list.

* If any part is missing or damaged, do not attempt to assemble the product.

* Estimated Assembly Time: 20 minutes.

* Tools Required for Assembly (not included): Screwdriver, Junction box

* If you are having difficulty, our friendly Customer Care team is always here to help.

NOTE: PLEASE USE TYPE "B" BULB MAX 25-WATT OR LED BULB MAX 5-WATT, THERE ARE 2PCS LED 4-WATT BULB IN THE BOX

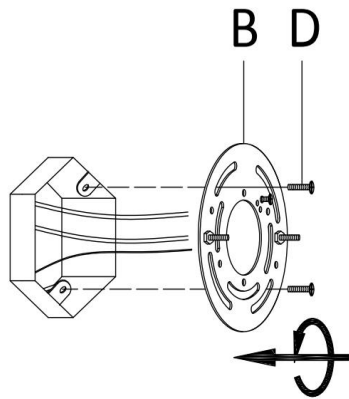

Step 1: Unpack all parts from cartons carefully. Separate the Mounting Plate (B) from the Lamp Body (E) by removing the Screwed Ball (F) anti-clockwise. Fix the Mounting Plate(B) to the junction box with Mounting Screw (D).

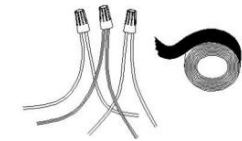
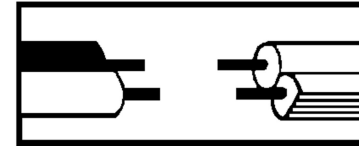

Step 2: Wire connection

Connect fixture neutral wire (ribbed) to the outlet box neutral wire (usually white) using a wire connector (A).

Connect fixture hot wire (smooth with markings) to the outlet box hot wire (usually black) using a wire connector (A).

CAUTION: Do not reverse the hot and neutral connections

Grounding Instructions:

Wrap ground wire from outlet box around green ground screw(C) on mounting bracket, no less than 2" from wire end. Tighten ground screw. If fixture is supplied with a ground wire, connect to outlet ground wire with a wire connector (A).

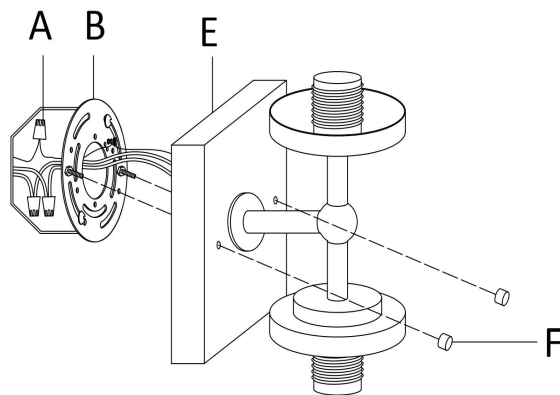

Step 3: Tuck wires inside junction box. Attach the Lamp Body (E) to the Mounting Plate (B) and secure with Screwed Ball (F).

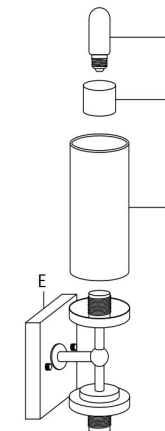

Step 4: Place the Glass Shade (G) over the socket of the lamp body (E), then secure with the Socket Ring (H). Insert the Bulb (I) into the Socket.