

# 4-in-1 Convertible Crib

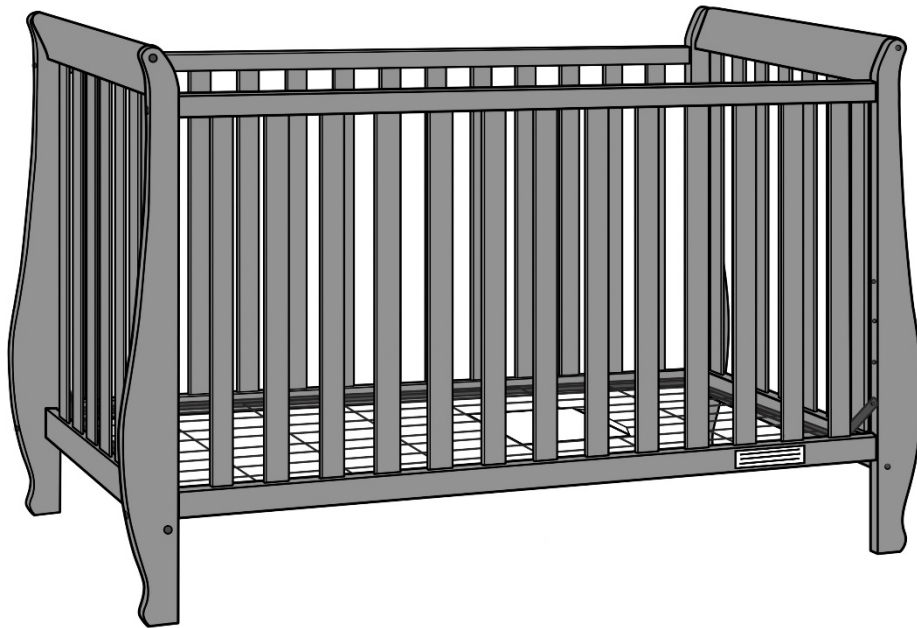

**THIS PRODUCT IS NOT INTENDED FOR INSTITUTIONAL OR COMMERCIAL USE.**

If you have any questions or missing parts, please contact us. DO NOT return product parts to the store where it was purchased before contacting Customer Service.

## **WARNING:**

**READ ALL WARNING & SAFETY INSTRUCTIONS BEFORE ASSEMBLING CRIB. KEEP INSTRUCTIONS WITH CRIB FOR FUTURE USE.**

First remove hardware from box and sort by size. Check to see that all hardware and wooden pieces are present before assembling.  
Follow instructions listed below in the proper sequence as numbered to assure fast, easy and correct assembly.

## **WARNING:**

- DO NOT attempt to repair or modify parts with cracks or defects. Please contact us for immediate replacement.
- This product is for home use and is not intended for use in schools, day care centers or other commercial establishments.
- Must be assembled by a capable adult.

# Crib Warnings

## **WARNING**

Failure to follow these warnings and the assembly instructions could result in serious injury or death.

- This crib conforms to applicable regulations promulgated by the Consumer Products Safety Commission.
- To reduce the risk of SIDS, pediatricians recommend healthy infants be placed on their backs to sleep, unless otherwise advised by your physician.
- DO NOT use a water mattress with this crib.
- If refinishing, use a non-toxic finish specified for children's products.
- Check fasteners periodically and never over tighten them, as this may cause distortion or breakage.
- Never use plastic shipping bags or other plastic film as mattress covers because they can cause suffocation.
- CAUTION: ANY MATTRESS USED IN THIS CRIB MUST BE AT LEAST 27-1/4 IN BY 51-5/8 IN (69CM X 131CM) WITH A THICKNESS THAT DOES NOT EXCEED 6 IN (15CM).
- Never leave child unattended inside crib. Remember that a crib is not a substitute for a parent's supervision.
- Parents should ensure a safe environment for their child by checking the crib regularly before placing the child in the products. Please make sure that every component is properly and securely in place.
- When a child is able to pull to a standing position, set the mattress to the lowest position and remove bumper pads, large toys and other objects that could serve as steps for climbing out.
- Infants can suffocate in gaps between crib sides and a mattress that is too small.
- Follow warnings on all products in a crib.

## **WARNING**

Infants can suffocate on soft bedding.  
Never add a pillow or comforter.  
Never place additional padding under an infant.

## **Strangulation Hazard**

- Strings can cause strangulation! Do not place items with a string around a child's neck, such as hood strings or pacifier cord. Do not suspend strings over a crib or attach strings to toys.
- To help prevent strangulation, tighten all fasteners. A child can trap parts of the body or clothing on loose fasteners.
- DO NOT place crib near windows where cords from blinds or drapes may strangle a child.
- Keep wall decorations, especially those with strings, completely out of a child's reach.

## **Fall Hazard**

- When child is able to pull to standing position, set mattress to lowest position and remove bumper pads, large toys and other objects that could serve as steps for climbing out.
- Stop using crib when child begins to climb out or reaches the heights of 35 in. (89cm).
- Check this product for damaged hardware, loose joints, and loose bolts or other fasteners, missing parts, or sharp edges before and after assembly and frequently during use. Securely tighten loose bolts and other fasteners. DO NOT use crib if any parts are missing, damaged or broken. Contact us for replacement parts and instructional literature if needed. DO NOT substitute parts.

**Storage:** The crib must be kept in a dry and clean area. Solid wood tends to exchange moisture with the surrounding air and reacts to major changes in temperature and humidity. It is best to place your furniture away from heating or air-conditioning vents. Direct exposure to sunlight can discolor the wood, so do not place your product where it will receive prolonged sunlight exposure.

**Care and Cleaning:** Do not scratch or chip the finish. Do not use abrasive chemicals for cleaning. Clean with mild soap on a soft rag. Rinse and dry thoroughly. If you choose to refinish this furniture, be sure to use only a non-toxic finish specified for children's products.

## **Toddler Bed Warnings**

### **WARNING ENTRAPMENTS STRANGULATIONS HAZARD**

Infants have died in toddler beds from entrapment and strangulation.

Failure to follow these warnings and assembly instructions could result in serious injury or death.

- The mattress intended for use on the bed shall be a full size crib mattress having a minimum dimensions 51-5/8 inches (1310mm) in length and 27-1/4 inches (690mm) in width and 4 inches (100mm) in thickness.
- The minimum age for a child using this toddler bed shall not be less than 15 months and the maximum weight shall not be greater than 50 lbs. (22.7 kg)
- DO NOT use with less than 12 inches of space between the toddler bed and solid objects such as a wall or dresser. Child could slide into smaller space and suffocate.
- NEVER place bed near window where cords from blinds or drapes may strangle a child.
- Strings can cause strangulation! DO NOT place items with a string around a child's neck, such as hood strings or pacifier cords. DO NOT suspend strings over a crib or attach strings to toys.
- DO NOT use a water mattress.
- DO NOT use casters on toddler bed.
- DO NOT suspend strings over a toddler bed for any reason.

- If guardrails are provided as the mattress containment means, guardrail(s) provided must be used to avoid the formation of a gap between the mattress and the bed that could cause entrapment. If mattress retention clips are provided they must be used to restrict mattress movement.

## Crib Parts and Hardware Diagram

Please follow this Parts and Hardware Diagram to make sure that all crib parts are assembled in the correct position.

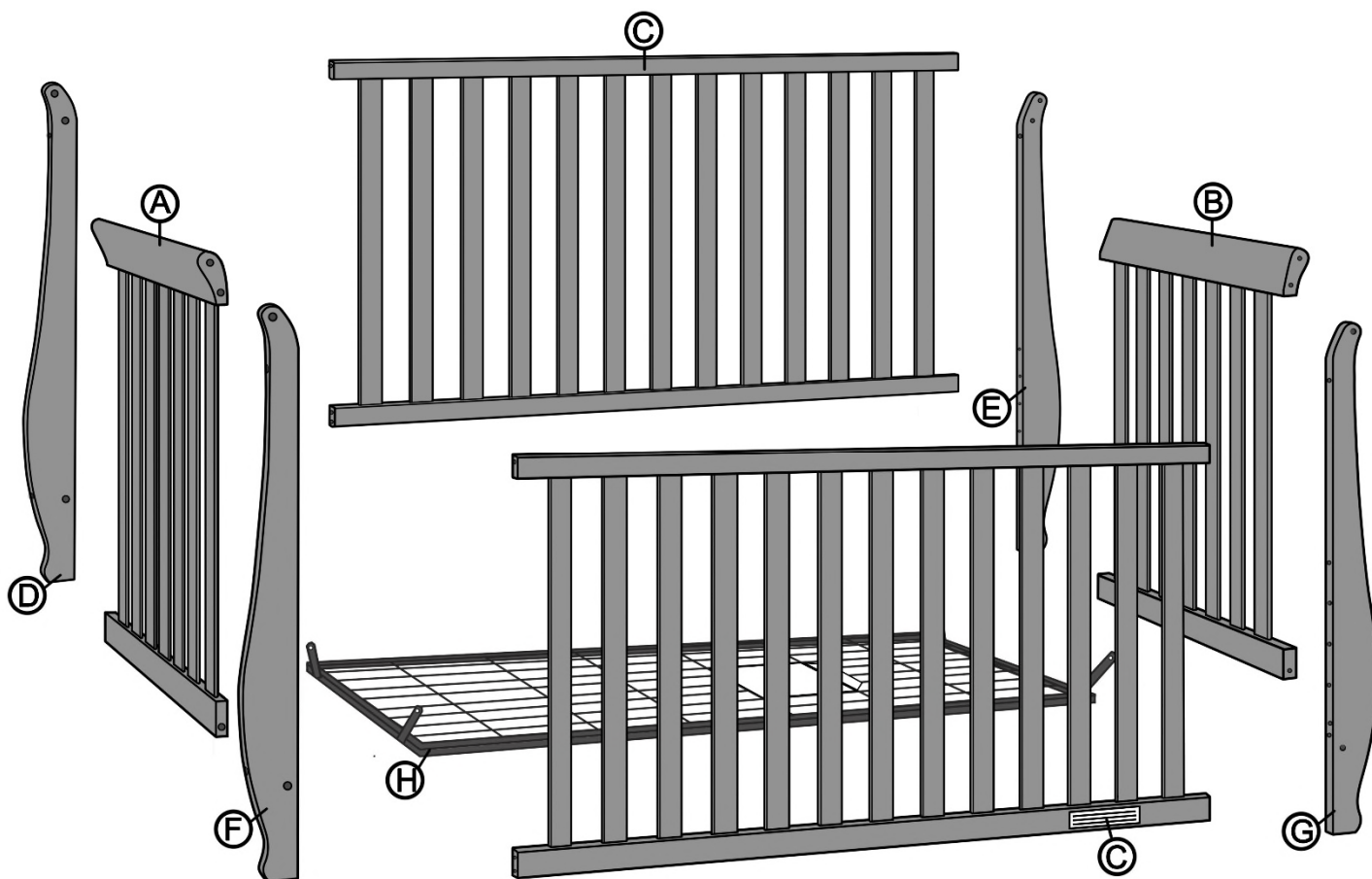







A.	Left Side Panel	(1 pc)
B.	Right Side Panel	(1 pc)
C.	Stationary Side Panels	(2 pcs)
D.	Rear Left Leg	(1 pc)
E.	Rear Right Leg	(1 pc)
F.	Front Left Leg	(1 pc)

G.	Front Right Leg	(1 pc)
H.	Mattress Support	(1 pc)

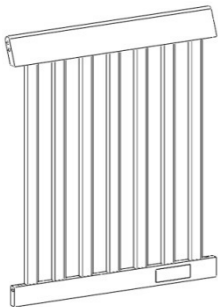
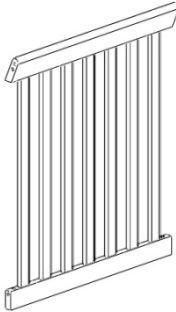
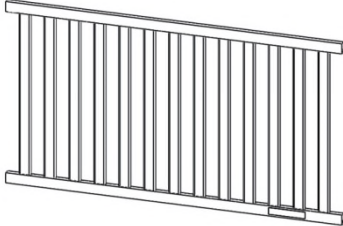
## Crib Parts Identification Sheet

DO NOT assemble crib if parts and hardware are defective or missing.  
Contact us for exchange or keep the original box for return authorization.

### ~ Crib Assembly Parts

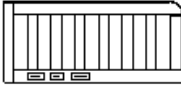
<p style="text-align: center;">A. Left Side Panel (1 pc)</p> 	<p style="text-align: center;">B. Right Side Panel (1 pc)</p> 	<p style="text-align: center;">C. Stationary Side Panels (2 pcs)</p> 	
<p style="text-align: center;">D. Rear Left Leg (1 pc)</p> 	<p style="text-align: center;">E. Rear Right Leg (1 pc)</p> 	<p style="text-align: center;">F. Front Left Leg (1 pc)</p> 	<p style="text-align: center;">G. Front Right Leg (1 pc)</p> 
<p style="text-align: center;">H. Mattress Support (1 pc)</p> 	<p style="text-align: center;">I. Stabilizer Bar (1 pc)</p> 	<p style="text-align: center;">J. Guardrail (1 pc)</p> 	

# Crib Hardware Identification Sheet

DO NOT assemble crib if parts and hardware are defective or missing.  
Contact us for exchange or keep the original box for return authorization.

## ~ Crib Assembly Hardware

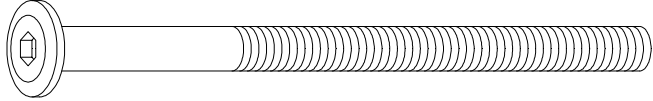
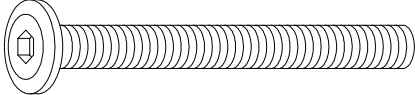
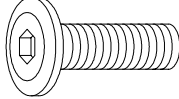
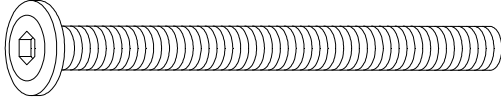
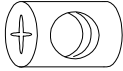
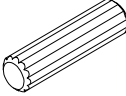
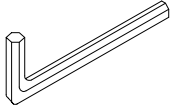
Item #	Fittings	Qty
1. Bolt M6 x 80mm		(8 pcs)
2. Bolt M6 x 45mm		(6 pcs)
3. Bolt M6 x 17mm		(4 pcs)
4. Bolt M6 x 60mm		(6 pcs)
5. Barrel Nut		(12 pcs)
6. Wood Dowel $\varnothing$ 8*30mm		(10 pcs)
7. Wrench		(1 pc)

PHILLIPS SCREWDRIVER

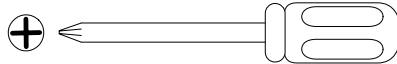

(NOT INCLUDED)

# Crib Assembly Sheet

## STEP 1:

- Insert 2 Wood Dowels (#6) into top rail of Left Side Panel (A).
- Attach Rear Left Leg (D) and Front Left Leg (F) to the Left Side Panel (A) by using 2 Bolts (#2) and 2 Bolts (#4).
- Repeat above steps to the Right Side Panel (B). Tighten firmly with Wrench (#7).

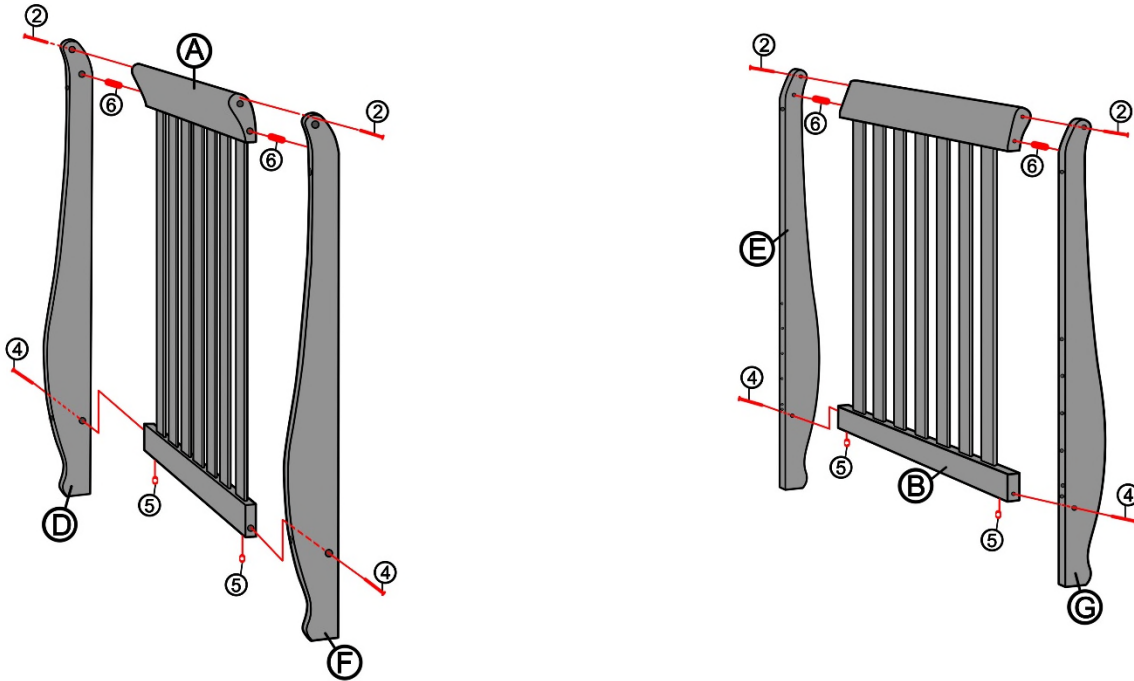

## STEP 2:

Attach Rear Left Leg (D) and Rear Right Leg (E) on the side panels to the Stationary Side Panel (C) by inserting 4 Barrel Nuts (#5) and 2 wood dowels (#6) on the underside of each corner of the stationary side panel before screwing 4 Bolts (#1) to secure the legs.

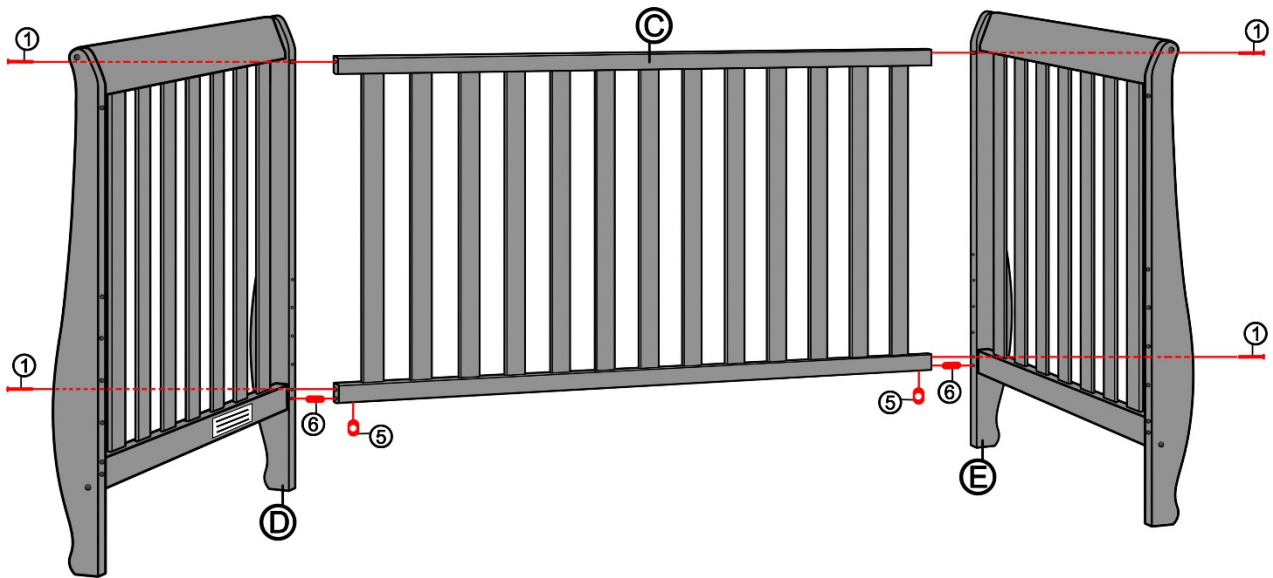

---

## Crib Assembly Sheet

---

### STEP 3

Attach Front Left Leg (F) and Front Right Leg (G) on the side panels to the Stationary Side Panel (C) by inserting 4 Barrel Nuts (#5) and 2 wood dowels (#6) on the underside of each corner of the stationary side panel before screwing 4 Bolts (#1) to secure the legs, Tighten Firmly.



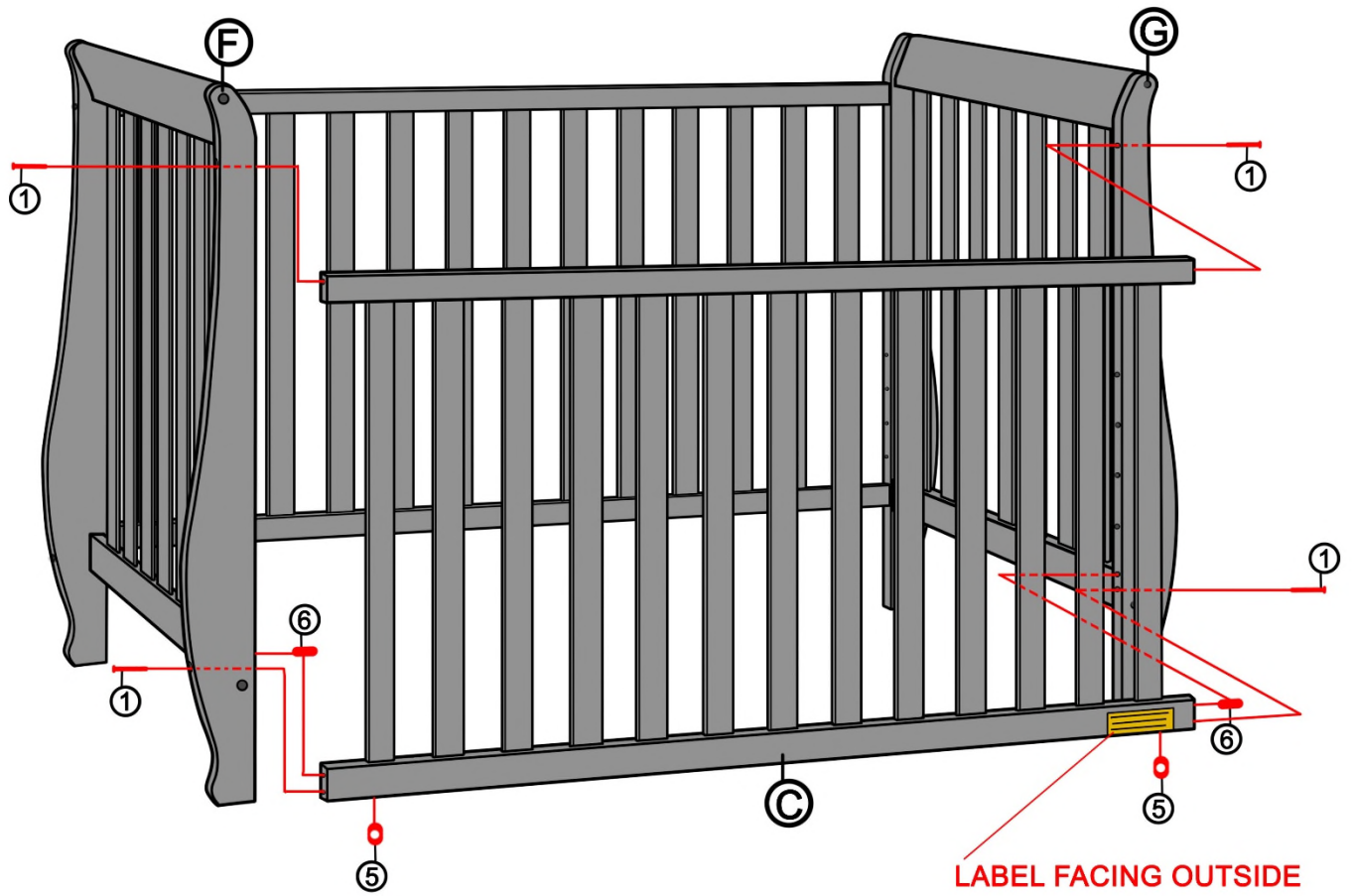

---

## Crib Assembly Sheet

---

## STEP 4

- a. Attach Mattress Support (H) flat side up by swinging out the four hangers at the corners of the mattress support and use 4 Bolts (#3) to attach hangers to the brackets on the legs at an even level on all sides.

**⚠ WARNING:**  
Make sure that the warning envelope on the Mattress Support Frame is facing up.

**⚠ WARNING:**  
Check components periodically, make sure Bolts are tightened properly and securely.

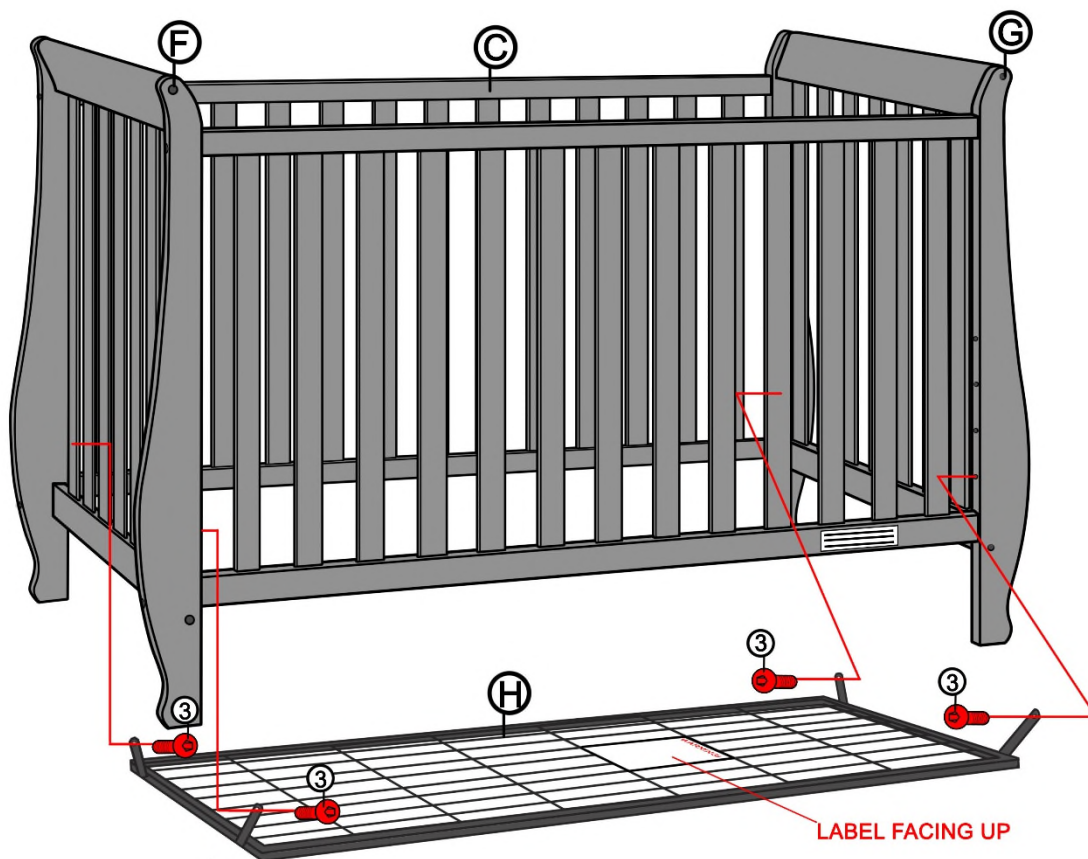
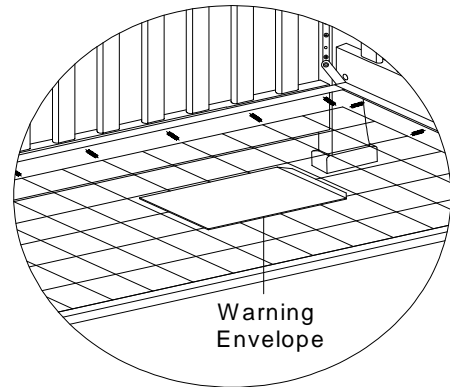

# Crib Assembly Sheet

---

Crib Assembly Complete

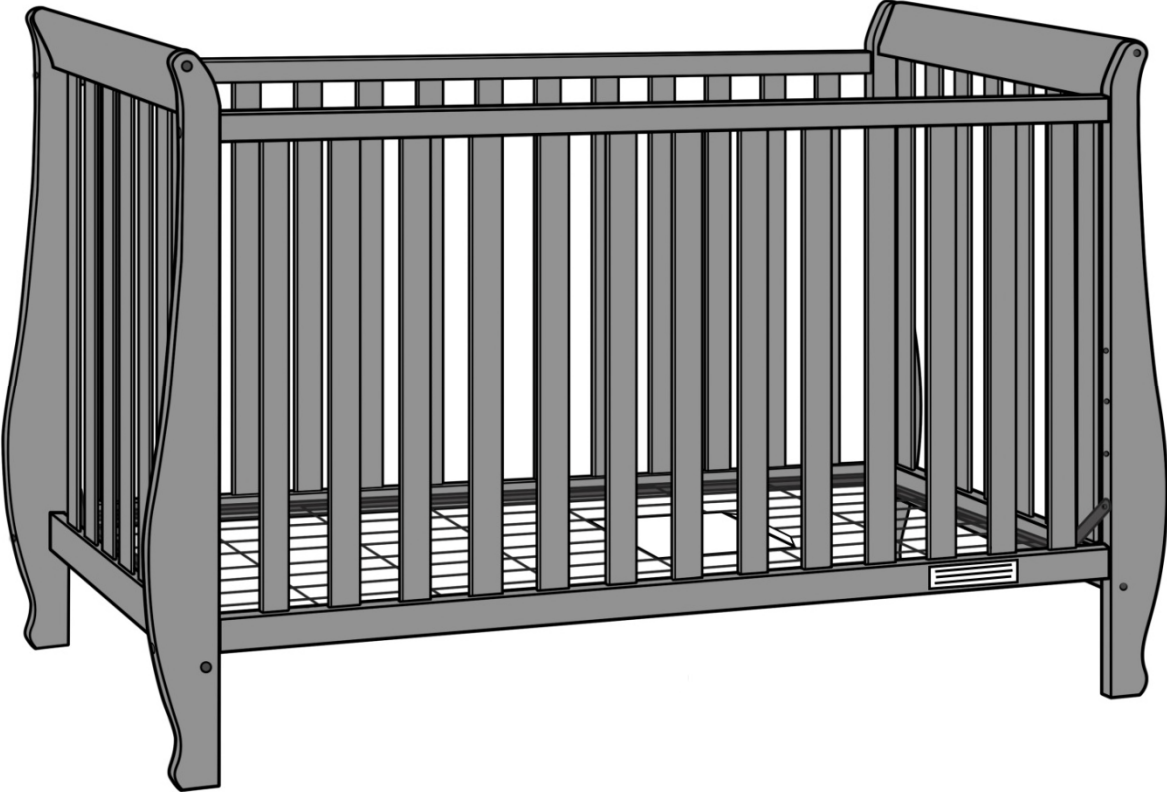

# Day Bed Assembly Sheet

**\*Mattress Support Assembly must be in the lowest position before installing day bed.**

- a. Loosen the Stationary Side Panel (C) bolts to detach the Stationary Side Panel.
- b. Attach Stabilizer Bar (I) to Left Side Panel (A) and Right Side Panel (B) with 2 Bolts (#1), 2 Barrel Nuts (#5) and 2 Dowels (#6).

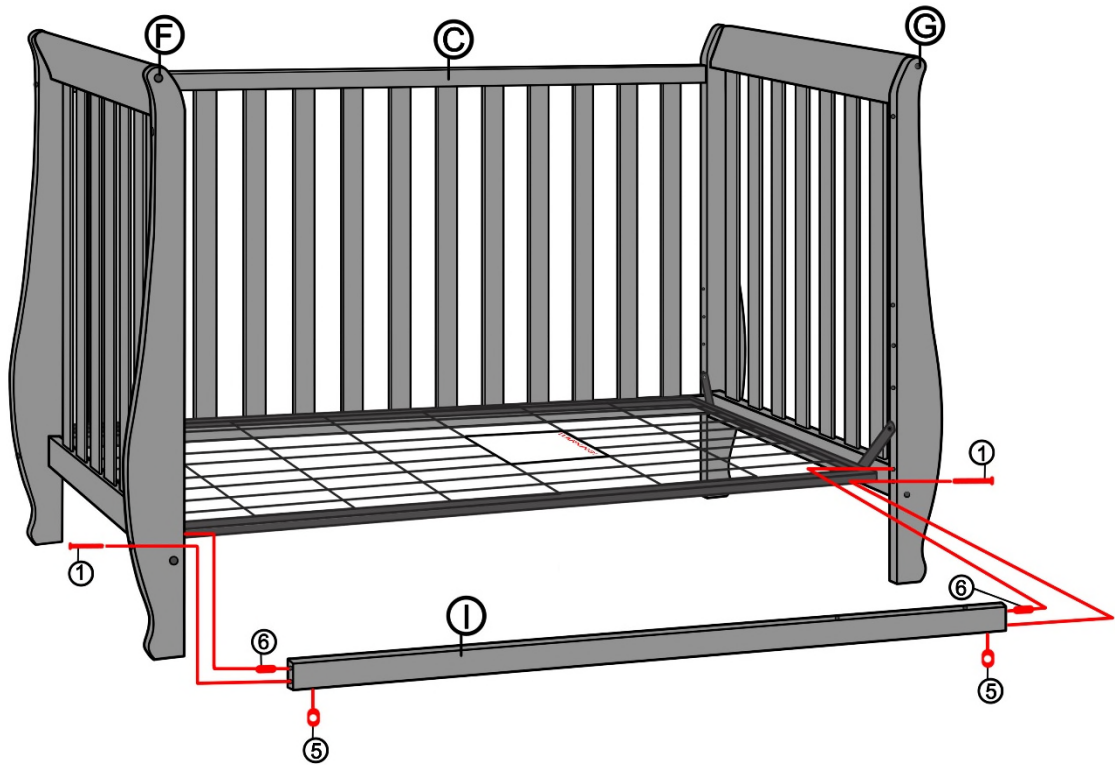

# Toddler Bed Assembly Sheet

**\*Mattress Support Assembly must be in the lowest position before installing guardrail.**

- a. Loosen the Stationary Side Panel (C) bolts to detach the Stationary Side Panel.
- b. Attach Stabilizer Bar (I) to Left Side Panel (A) and Right Side Panel (B) with 2 Bolts (#1), 2 Barrel Nuts (#5) and 2 Dowels (#6).
- c. Attach Guardrail (J) to Stabilizer Bar (E) by using 2 Bolts (#4) and Left Side Panel (A) by using 2 Bolts (#2).

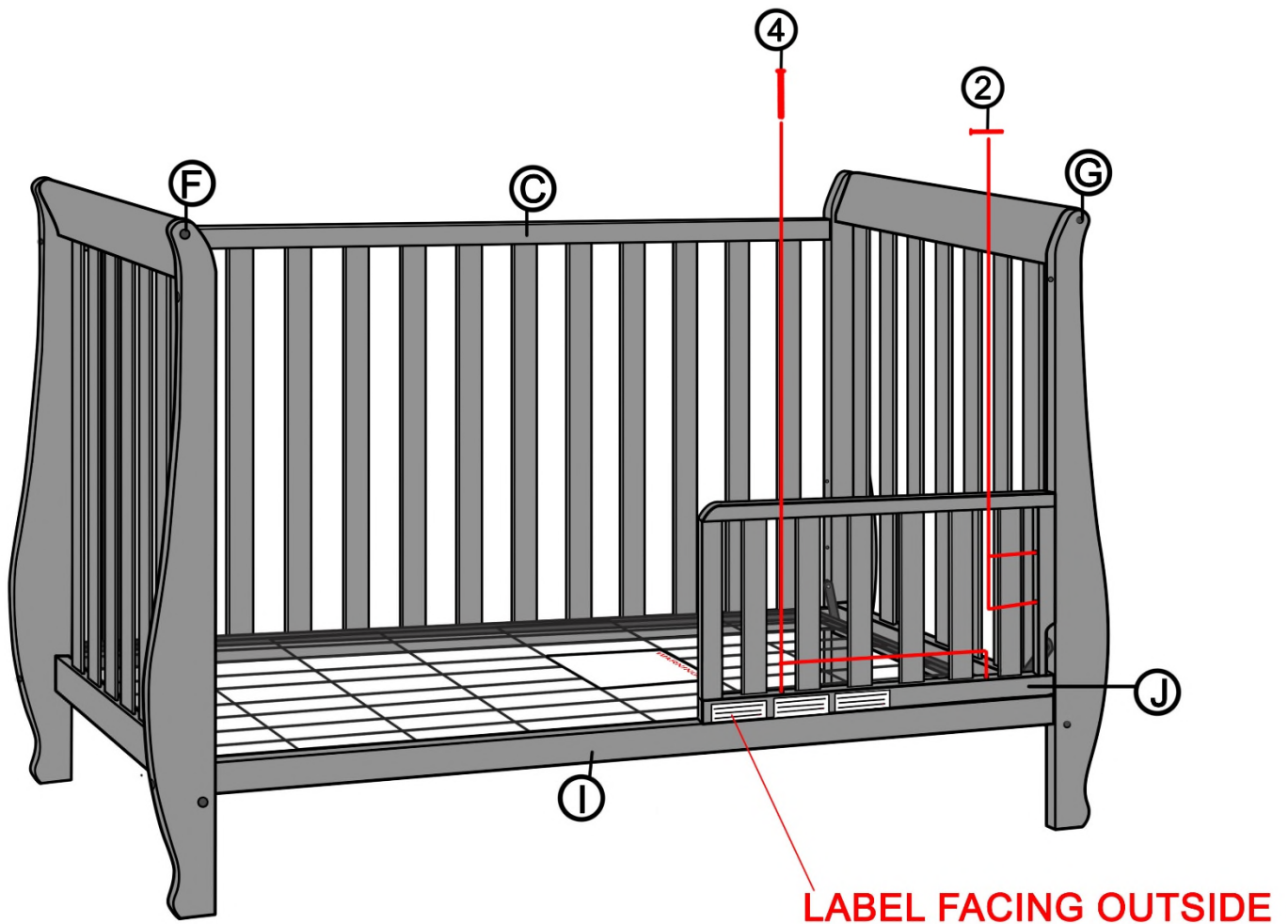

# Full Size Bed Assembly Sheet

---

**(Full Size Be Rails not included)**

**\*Metal frames can be purchased at any furniture store**

- Attach the Stationary Side Panel (C) with Front Left Leg (F), Front Right Leg (G). Using this as the headboard for the full size bed
- By using the bottom holes of the headboard, assemble the headboard by using the mattress support metal-frame rail.
- Attach the Stationary Side Panel (C) with Rear Left Leg (D), Rear Right Leg (E). Using this as the footboard for the full size bed
- By using the bottom holes of the footboard, assemble the footboard by using the mattress support metal-frame rail

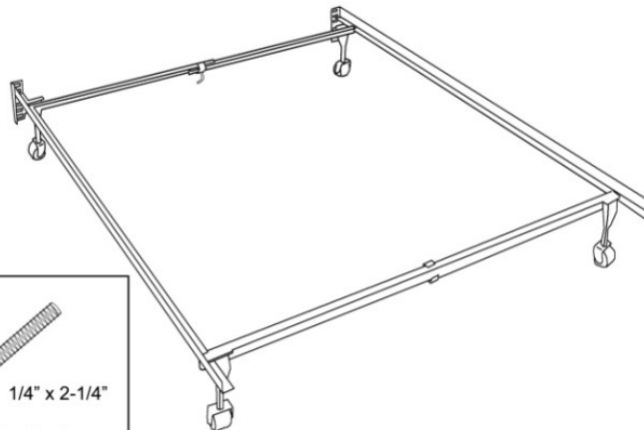
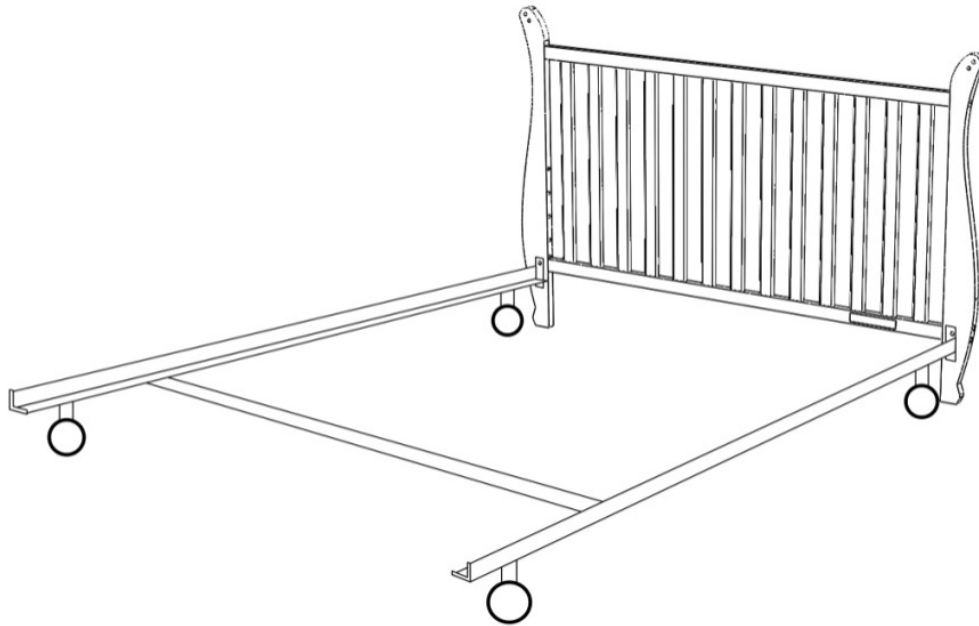

## Safety Tips for Assembling and Re-assembling Cribs

- Parents should not use any crib with missing, broken or loose hardware parts. Crib slats or spindles should be spaced no more than 2-3/8" apart, and none should be loose or missing. NEVER use a crib with corner posts over 1/16" of an inch above the end panels (unless they are over 16" high for a canopy).
- Check this product for damaged hardware, loose joints, loose bolts or other fasteners, missing parts, or sharp edges before and after assembly and frequently during use. Securely tighten loose bolts and other fasteners. DO NOT use crib if any parts are missing, damaged or broken. Contact us for replacement parts and instructional literature if needed. DO NOT substitute parts.
- Never place infants to sleep on pillows, sofa cushions, adult beds, waterbeds, beanbags, or any other surface not specifically designed for infant sleep.
- Always check all sides and corners of the crib to assure proper assembly with no openings that may entrap a child. The crib mattress should fit snugly with no more than two fingers width, one-inch, between the edge of the mattress and the crib side. Otherwise, the baby can get trapped between the mattress and the side of the crib.
- Do not try to repair any side of the crib without manufacturer-approved hardware.
- Putting a broken side up against the wall is not a solution and can often make the situation worse.
- When re-assembling the crib for your second child, please keep in mind that the screw holes will need to be filled in order for the screws to grip to the wood. Talk to your local hardware store or lumberyard about how to do it properly.

### One year limited warranty

We want you to be satisfied with any product that bears our name or logo. We will provide promptly, at the request of the retailer, and without charge, any missing parts that have been reported, with proper description, within 7 days of the purchase of the products. Our warranty guarantees optimal workmanship and lack of significant defects. The product warranty lasts a year from the date of your purchase. Please keep the original receipt so that we may process your one year limited warranty request. This warranty only covers new units with original packaging. Ownership of the warranty is non-transferable. The warranty does not cover any used, second-hand, or demo models. Our obligation under this warranty is to replace or repair the merchandise, at our option, free of charge. This warranty does not cover any damaged or defective parts that result from normal wear and tear, abuse, negligence, improper use or alteration to the finish design, and hardware. Specific rights issued by this warranty may vary from state to state. Some states do not allow limitations on how long implied warranties last. DO NOT return products to the store once a product is used, it cannot be resold and the materials and energy invested in the product would go to waste. In the event that we determine that a defect that may result from customer abuse or misuse, we will contact you with information about services and methods to prevent occurrences. We strongly recommend you register your product with our company by filling out registration and mailing it back to us. This ensures you are up-to-date with our products' maintenance and information.

This warranty does not cover damage caused by accident, misuse or any use other than as intended and described in this assembly sheet or damage resulting from failure to maintain and clean this product as specified in this assembly sheet. This warranty applies only to the original purchaser of the product.

## CAUTION! Safety Tips for Use of Cribs

**Many older cribs, including secondhand or second use cribs, may not meet all current safety standards. For baby's safety, even if you are on a tight budget, you should not purchase a used crib at a garage sale or accept a hand-me-down that does not meet the most recent Federal and ASTM standards.**