

ASSEMBLY INSTRUCTIONS











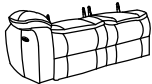

LSF POWER RECLINING LOVESEAT, RSF POWER DOUBLE RECLINING LOVESEAT WITH CONSOLE, RECEPTACLES AND USB PORTS, CORNER SEAT



Hardware are stored under the mechanism, please take out the hardware for assembly.

Note: Do not use power tools for assembly. Power tools increase the risk of over tightening which lead to splitting or cracking the wood.

Component list

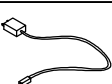
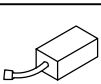
No	Drawing	Qty	Description
A		1	LSF SEAT
B		1	LSF BACK REST
C		1	RSF BACK REST
D		1	LSF WING
E		1	RSF SEAT + RSF ARM + CONSOLE
F		1	LSF BACK REST FOR (E)
G		1	CONSOLE BACK REST
H		1	RSF BACK REST FOR (E)
I		1	RSF EAR
J		1	CORNER SEAT
K		1	LSF CORNER BACK
L		1	RSF CORNER BACK
M		2	STAR KNOB
N		2	PLUG
P		2	ADAPTOR

Step #1

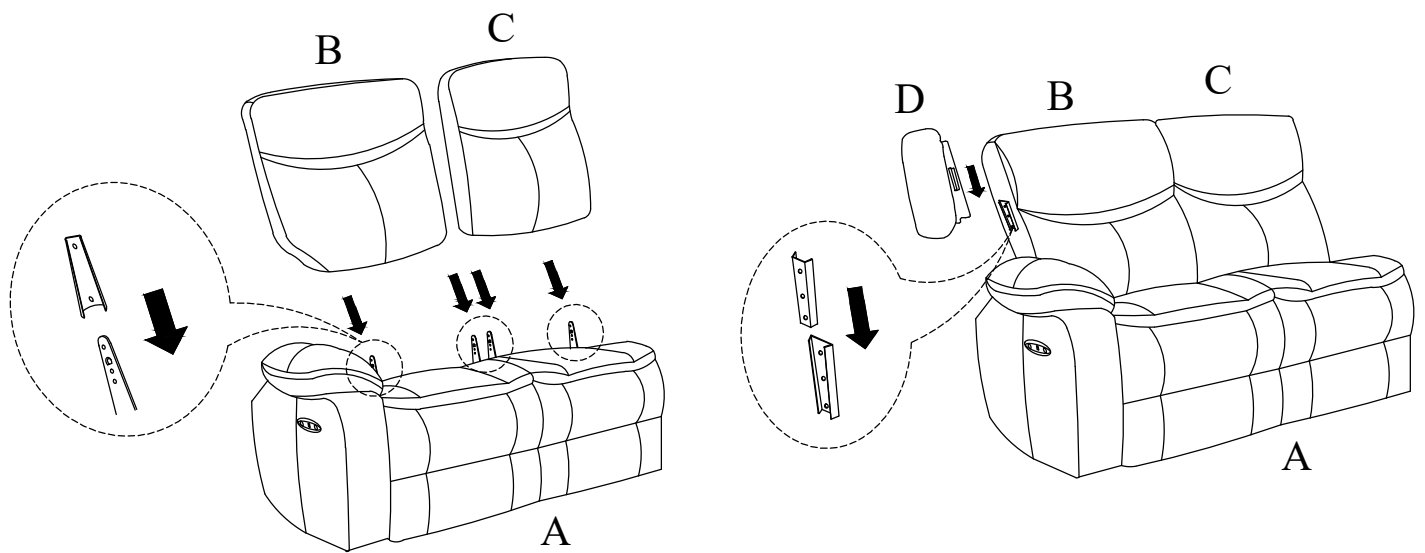

Step #2

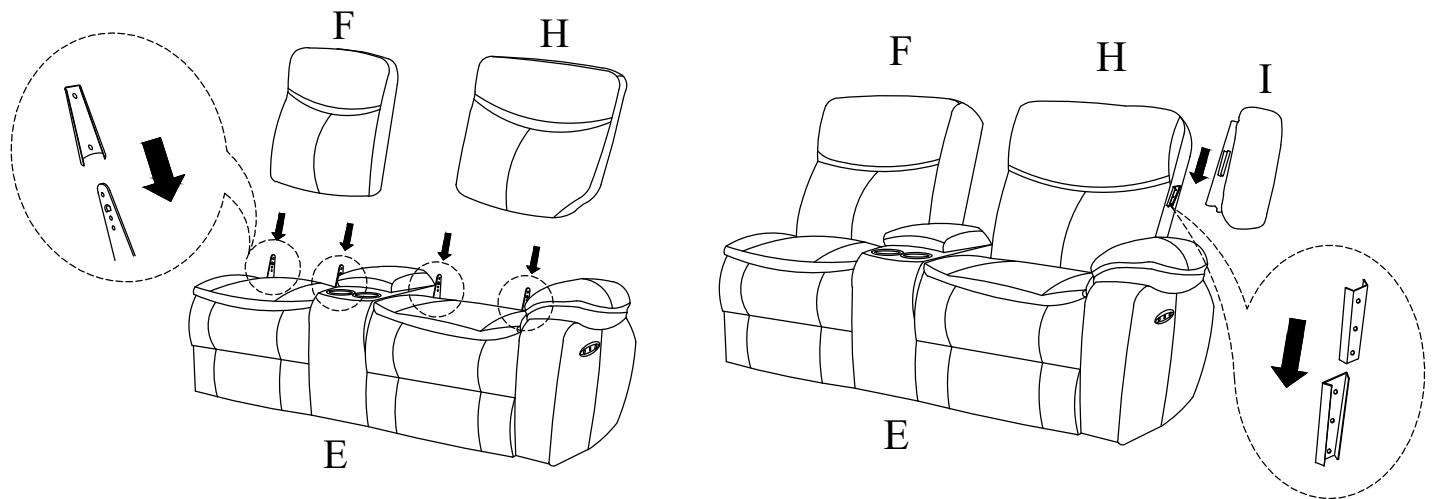

Step #3

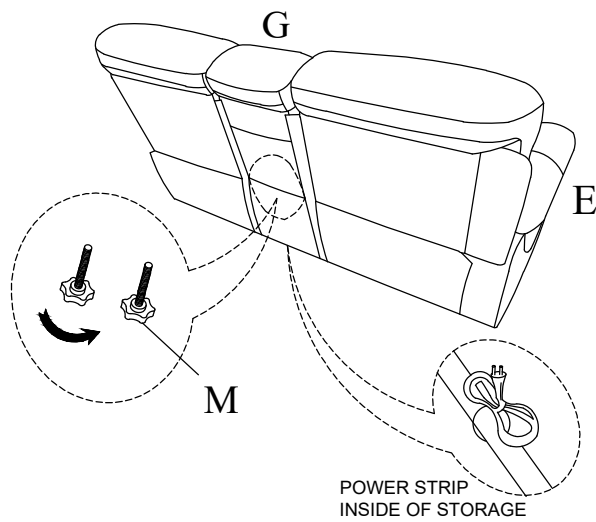

Step # 4

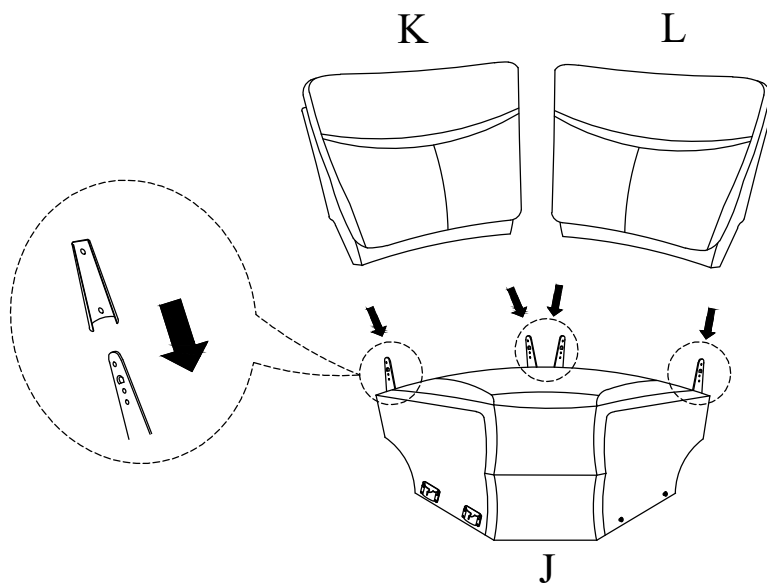

Step # 5

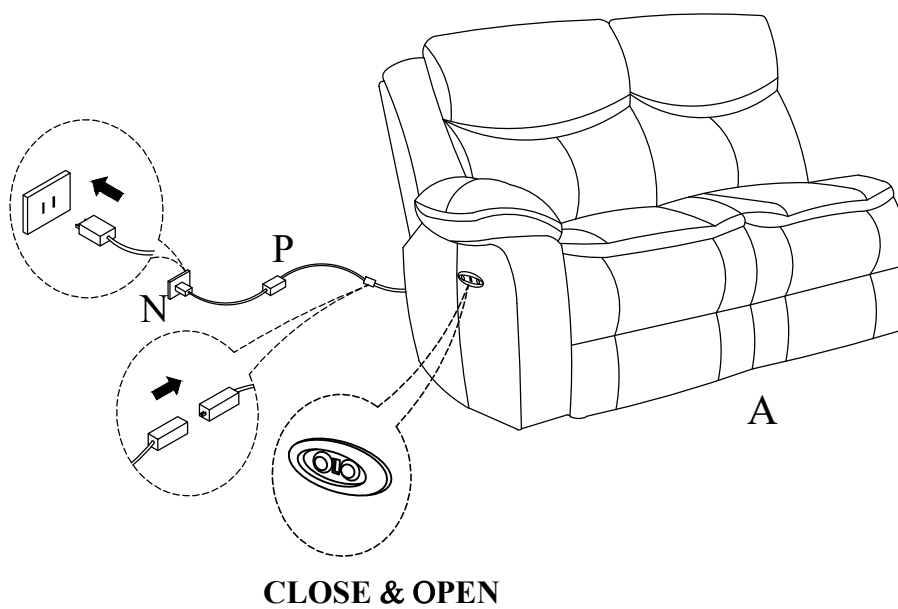

Step # 6

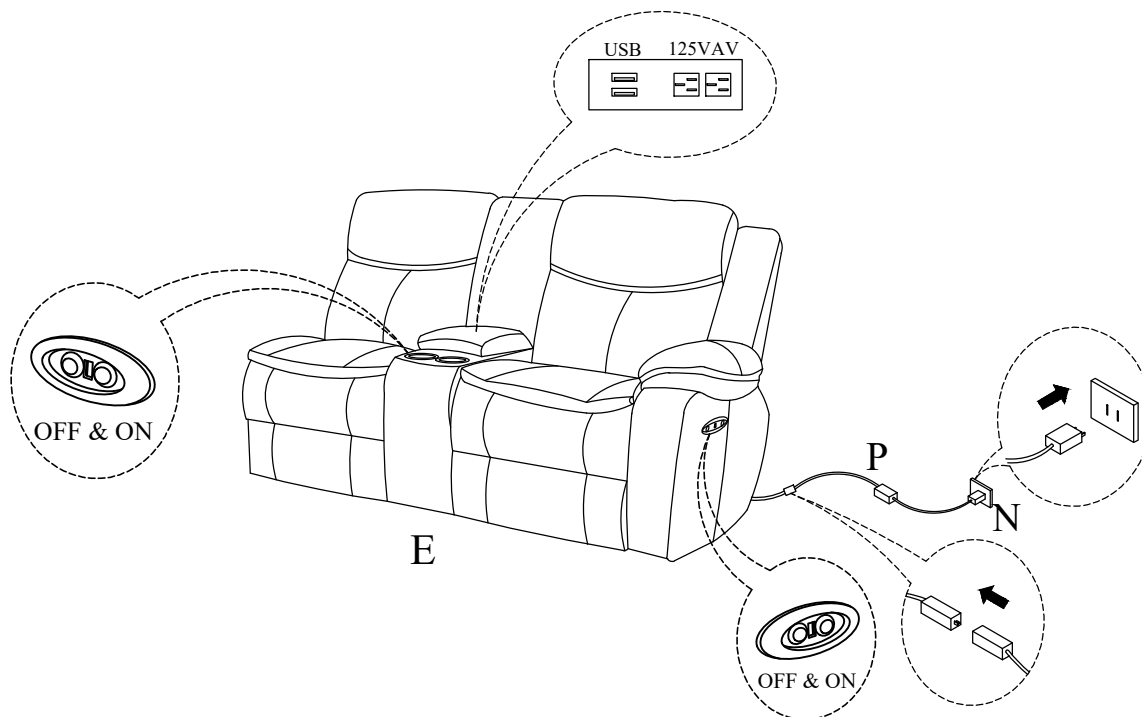

Step # 7

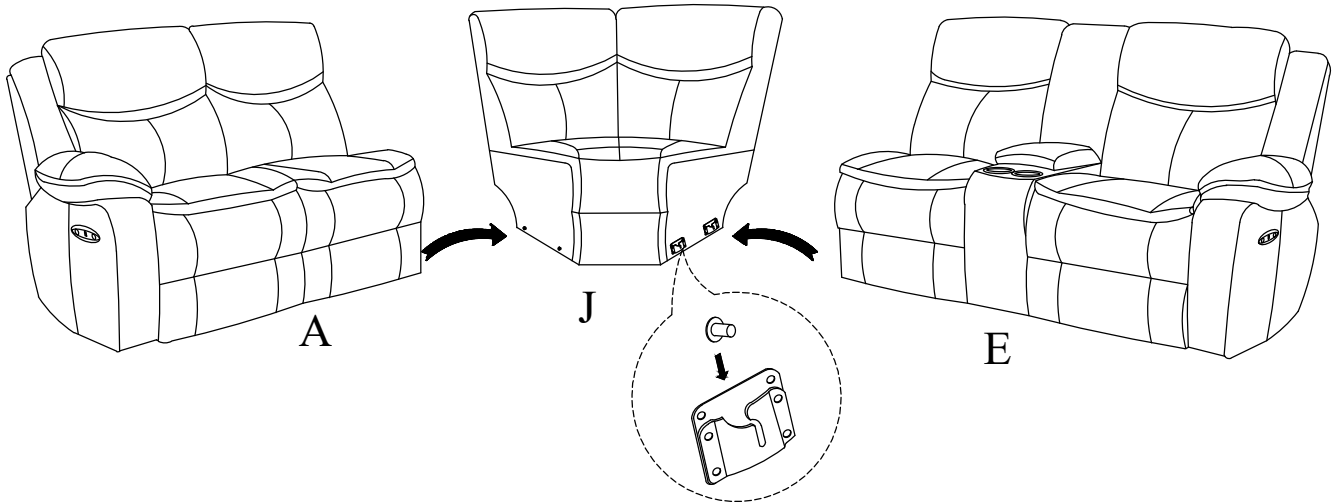

Step # 8

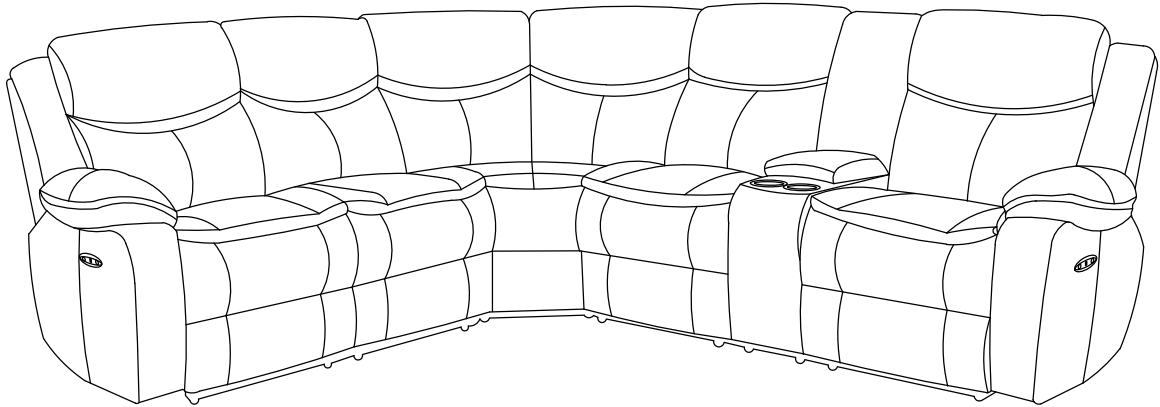

Care Instruction for Leather Air Furniture:

In order to maintain the original appearance of your leather air Furniture, please follow below simple care procedures:

- Avoid exposing furniture directly to sunlight or heating and air conditioning outlets. Sunlight and or exposure to heating and air conditioning outlets will fade/damage leather air.
- Vacuum or wipe with a soft cloth to remove dust.



For items use on wooden floor, hard surfaces or carpets, it is recommended to Install protective pads under all legs and supports to avoid/prevent from damages/scratches and discoloration.