

## WARNING

- \* Switch off the main electrical supply from the main fuse box / circuit breaker before installation.
- \* Inspect item carefully before attempting to install.
- \* If there is any damages or obvious defects, do not install.
- \* Item may not be returned once it has been installed.







## CARE AND MAINTENANCE

- \* To clean the outside of the fixture, use a dry or slightly dampened clean cloth (use clean water, never a solvent) to wipe the surface of the fixture.
- \* To clean the inside of the fixture, first disconnect power to the fixture by turning off the circuit breaker or by removing the fuse at the fuse box. Next, use a dry or slightly dampened clean cloth (use clean water, never a solvent) to wipe the interior surface of the fixture.
- \* Do not use any cleaners with chemical, solvents or harsh abrasives. Use only a dry soft cloth to dust or wipe carefully.

## NOTICE& IMPORTANT SAFETY INSTRUCTIONS

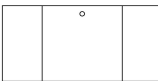
- \*\* WE RECOMMEND INSTALLATION OF THIS LIGHTING FIXTURE BE DONE BY A LICENSED ELECTRICIAN \*\*
- \* Please make sure that you have all parts indicated before you begin assembly of this item
- \* This item should be assembled on a soft surface to prevent scratching the finish during assembly
- \* To reduce the risk of fire, electrical shock or injury to persons or property, please follow the guideline below for safe use and installation
- \*The external flexible cable or cord of this lamp cannot be replaced  
If the cord is damaged, the lamp shall be destroyed

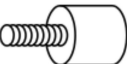
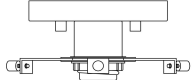
### Part List and Hardware List

PIECE	DESCRIPTION	PICTURE	QUANTITY	PIECE	DESCRIPTION	PICTURE	QUANTITY
A	Mounting Plate		1X	E	Canopy Nut		2X
B	Wire Nut		3X	F	Shade		1X
C	Mounting Screw	 	2X	G	ball nut		3X
D	lamp body		1X	H	Bulb		1X

**Model#: FLU4117**

**Product Dimensions: 8"L X 8"W X 6.5"H**

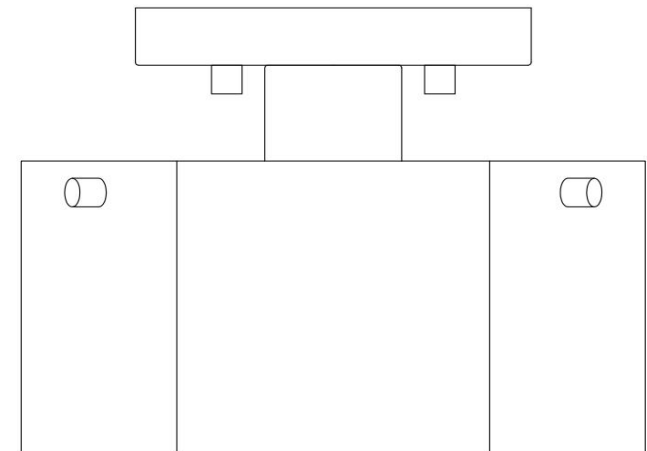

## PREPARATION

- \* Before beginning assembly of product, make sure all parts are present. Compare parts with package contents list and hardware contents list.
- \* If any part is missing or damaged, do not attempt to assemble the product.
- \* Estimated Assembly Time: 15 minutes.
- \* Tools Required for Assembly (not included): Screwdriver, Junction box
- \* If you are having difficulty, our friendly Customer Care team is always here to help. Please email [customersupport@safavieh.com](mailto:customersupport@safavieh.com)

**NOTE: PLEASE USE TYPE "A" BULB MAX 40-WATT OR LED BULB MAX 9-WATT, THERE IS 4-WATT LED BULB IN THE BOX**

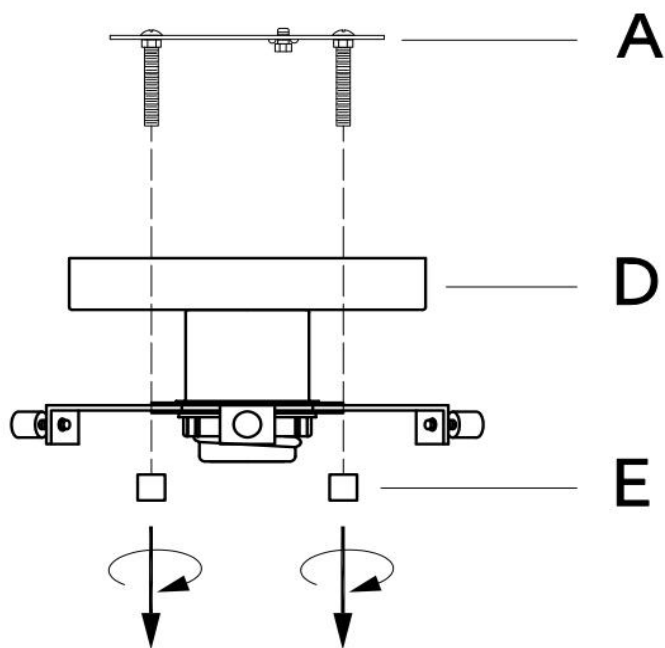

**Step 1:** Unpack all parts from cartons carefully. Separate the Mounting Plate(A) from the lamp body(D) by removing the Canopy Nut(E) anti-clockwise.

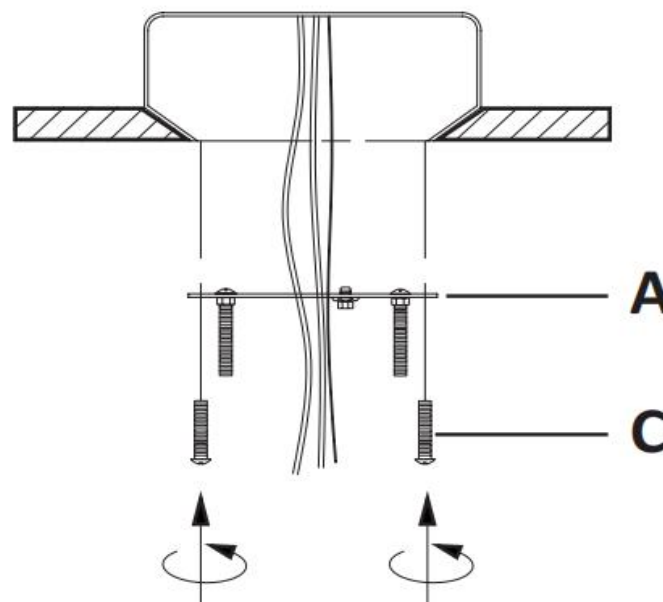

**Step 2:** Insert the J-box wires through the opening of Mounting Plate (A). Attach the Mounting Plate (A) onto the J-box and secure it by turning the 2 Mounting Screws (C) clockwise until tight.

## PREPARATION

\* Before beginning assembly of product, make sure all parts are present. Compare parts with package contents list and hardware contents list.

\* If any part is missing or damaged, do not attempt to assemble the product.

\* Estimated Assembly Time: 15 minutes.

\* Tools Required for Assembly (not included): Screwdriver, Junction box

\* If you are having difficulty, our friendly Customer Care team is always here to help. Please email [customersupport@safavieh.com](mailto:customersupport@safavieh.com)



### Step 3: Wire connection.

Connect fixture neutral wire (ribbed) to the outlet box neutral wire (usually white) using a wire nut.

Connect fixture hot wire (smooth with markings) to the outlet box hot wire (usually black) using a wire nut.

CAUTION: Do not reverse the hot and neutral connections.

Grounding Instructions:

Wrap ground wire from outlet box around ground screw on mounting plate, no less than 2" from wire end. Tighten ground screw. If fixture is supplied with a ground wire, connect to outlet ground wire with a wire nut.

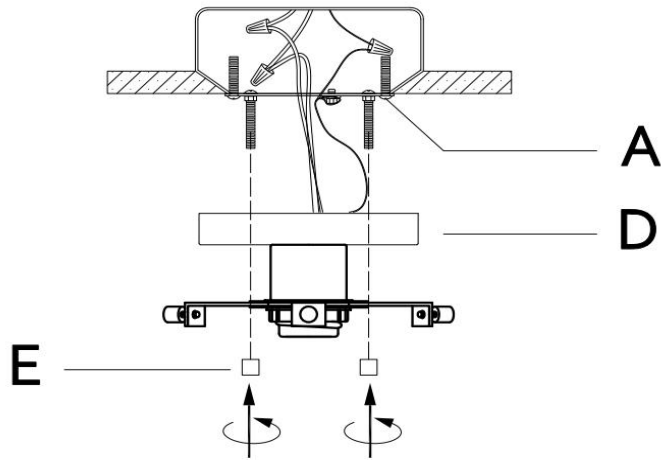

**Step 4:** Attach the Canopy(D) to the Mounting Plate (A) and fix it by turning the Canopy Nut (E) clockwise.

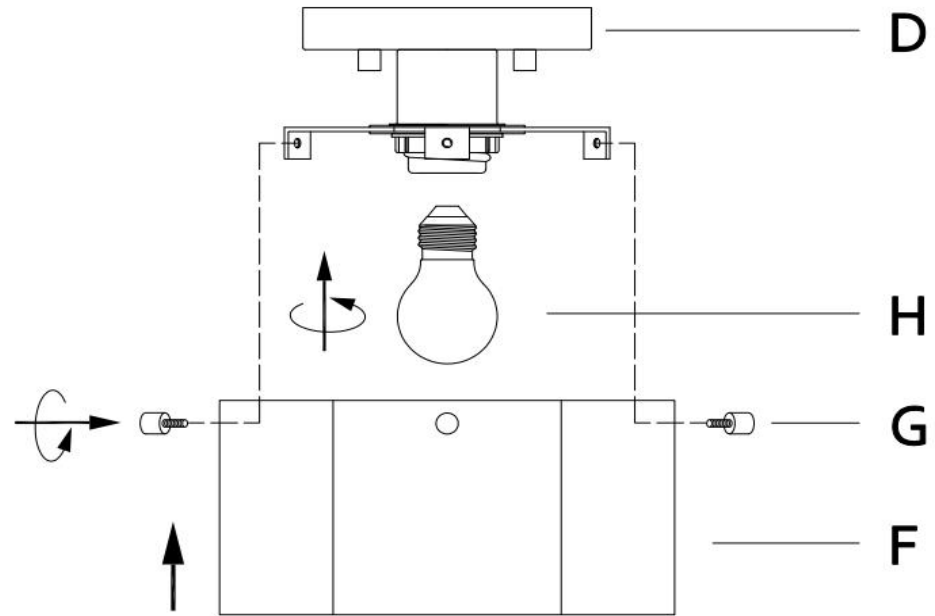

**Step 5:** Separate the ball nut (G) from the lamp body (D) anti-clockwise, Insert the bulb(H) into the sockets until secure. place the Shade (F) over the lamp body (D), align the three holes of the Shade (F) to of the lamp body (D) the three hole, then tighten the ball nut (G).