

**COFFEE TABLE FRIDGE WITH  
ALL-IN-ONE REFRIGERATOR DRAWERS**

# **USER GUIDE**

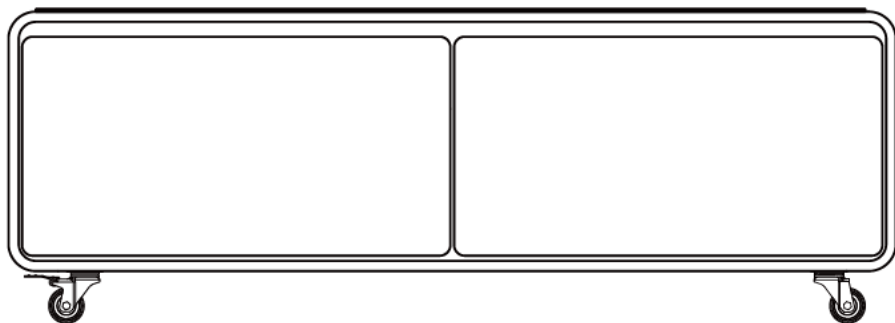

In case you might need to return this product, please keep all the packaging materials and return only in its original packaging and in excellent condition.

Parts & features .....	01
Specifications .....	02
Packing list .....	02
Precaution before use - unpacking .....	03
Notice .....	04
Installing the power cord .....	06
Functions and features .....	07
User guide .....	09
Daily maintenance .....	15
Delivery and outage .....	17
Non-failure .....	18
Trouble shooting .....	19

---

## PARTS & FEATURES

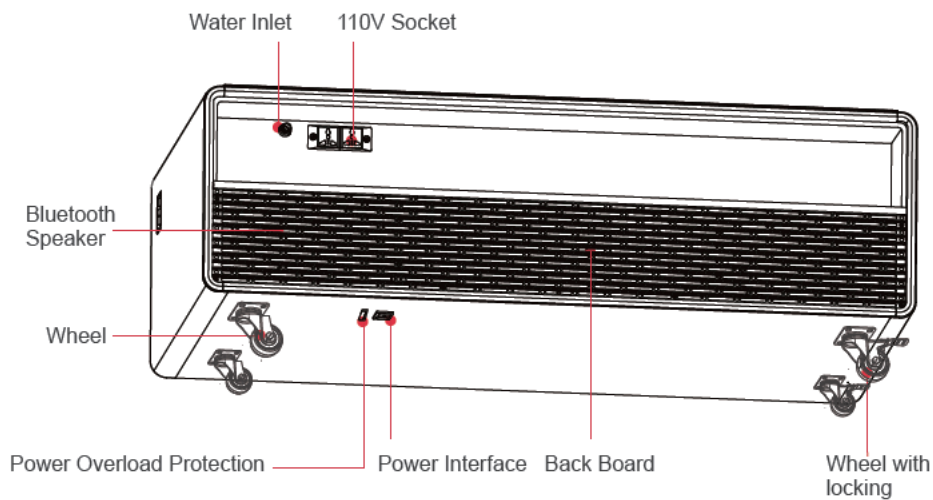
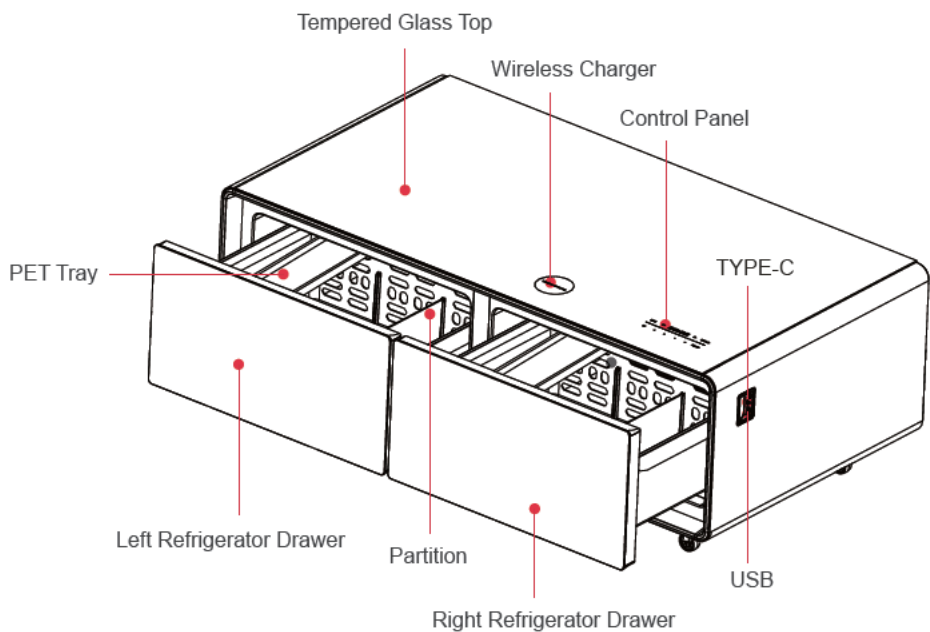



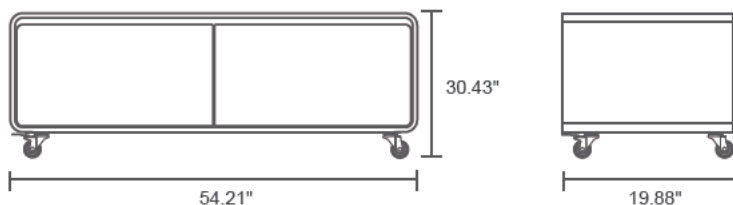

## SPECIFICATIONS

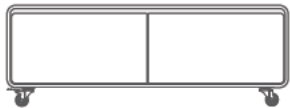

Consumption	160kWh/year	Packing Size	55.9" x 32.3" x 22.4"
Noise Level	36db	Temp Control	Electronic Control
Voltage	110V-120V/60HZ	Refrigeration Mode	Compressor
Net Weight	137.79 lbs	Refrigerant/Wt	R600a/25g
Gross Weight	162.04 lbs	Volume	70L+65L
Controlling	Electronic Control	Left Drawer Temp Range	37°F~46°F
Product Dimensions	54.21"x30.43"x19.88"	Right Drawer Temp Range	43°F~54°F
Wireless Charger	15W	USB Type-c	5V/2.1A
Speaker	Bluetooth	Speaker Watts	20W*2

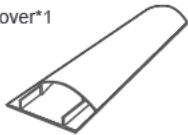
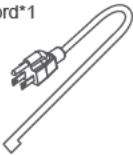
## PACKING LIST

<p>Main Body*1</p> 	<p>Partition*4</p> 	<p>PET Tray*2</p> 
<p>Cable Cover*1</p> 	<p>Power Cord*1</p> 	<p>User Manual*1</p> 

## PRECAUTION BEFORE USE - UNPACKING

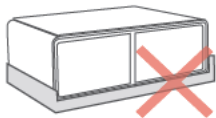

For better heat dissipation, remove the foam base, peel off the adhesive tape and the transparent film from the surface of the table. Fail to do so may result in personal injury or property damage.

### ENSURE ALL ACCESSORIES ARE INCLUDED ACCORDING TO THE PACKING LIST IN PAGE 2.

### TABLE PLACEMENT CONDITIONS

1. Please use the cable cover to protect the power cord if your floor is not installed with power socket and carpet.
2. Avoid high humidity, super cold environment and directly sunlight places.
3. Make sure that there are enough space on all sides around the Smart Coffee Table to ensure adequate ventilation for the refrigerator (see attached picture). Do not place the back of the Smart Coffee Table against a wall as this may result in overheating.
4. The table should be put on flat and solid ground. After determining the position and placing it smoothly, it is necessary to step on the brake device of the brake wheel and fix the position of the table to prevent random sliding.
5. Universal wheel: change the direction of travel at will, and pass easily on complex roads. Brake wheel: one tap and stop. Steering wheels double fixed

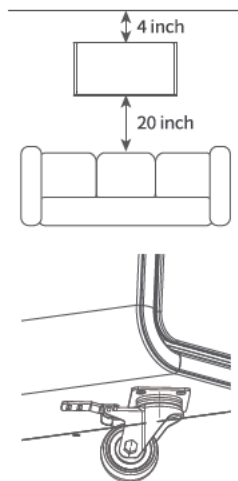

### PLEASE CLEAN THE TABLE BEFORE USING

Please refer to page 15 for daily maintenance and repair.

### RESTING

After leveling and cleaning the table, do not power on at once. Before connecting the appliance to an electrical power supply, let the smart coffee table unplugged for about 2 hours in its final location, This will reduce the possibility of a malfunction in the cooling system due to mishandling or jostling in transport.

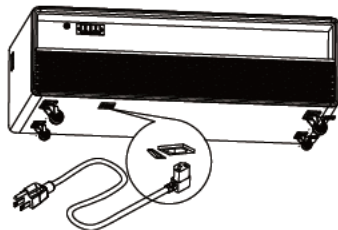

### POWER ON

After unplug for 2 hours, carefully check if there is any water or foreign object around the power socket and USB ports, then connect the power cable under the bottom of the table, see picture above. Please make sure the cable is safely installed and can come in handy, to minimize daily wear and tear of the power cord and avoid users being accidentally tripped over.



The maximum power draw on the smart coffee table is 960 watts for all the outlets combined. Please do not connect to a multipurpose power outlet.

## NOTICE

### NOTICE

#### **ELECTRIC WARNINGS**

1. After powering on the unit, please install the cable cover to prevent any damage of the cable. Do not step on the cable, otherwise it will raise the risk for electric leakage.
2. The power cord should be kept in firm contact with the power source. Failure to do so may result in property damage, personal injury or fire.
3. To avoid damage to the cable, please do not step on the cable. Do not roll over the cable when moving the table.
4. When removing the power plug from the wall outlet, always pull directly on the plug, never pull the cord. Before cleaning, repairing or replacing any parts, unplug the table to avoid electric shock.
5. Do not use if the power cord is damaged or the plug is worn. Please make sure to go to the manufacturer's designated repair center or online authorized dealer for replacement.
6. For this R600a refrigerator, please ensure that maintenance is carried out by professionally trained technicians. If the equipment is damaged, please send it to a nearby service center for inspection, repair or adjustment.

#### **POWER SUPPLY WARNING**

This table should be powered by AC110V. If the voltage fluctuation is out of range, it may cause unit failure, property damage or personal injury.

#### **GROUND POWER WARNING**

Use a dedicated socket and ground the device properly. The power cord is equipped with a three-wire (grounding) plug and should be used with a standard three-wire (grounding) socket. Under no circumstances should the third prong (grounding) of the power cord be cut off or removed.

#### **STORAGE WARNING**

This table should not be used to store any products that are inflammable, explosive or dangerous, as well as any chemicals. Blood or other biological products is prohibited to be stored in it.

#### **USB**

Keep liquids away from USB ports. Do not use wet cloth to clean the ports.

#### **110 POWER PORT**

1. Keep liquids away from socket. Do not use wet cloth to clean.
2. The rated power of connecting this electric appliance cannot exceed 960W. Overloading will lead to over heating and will cause fire. Even will cause property damage or personal injury.
3. Please do not connect to a multipurpose power outlet

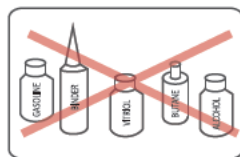

## WIRELESS CHARGER

- 1.If the device is equipped with a thick protective shell or a metal protective shell, the charging efficiency may be affected. Remove the shell and try again.
- 2.The wireless charger may generate heat when charging. If the battery overheats, the software may limit the charging. It will begin to charge once the temperature drops.
- 3.Wireless charging and the USB charging should not be used in the same time.

## SPEAKER

This product should by all means avoid any contact with water, moist, heat, or devices that may generate magnetic and/or electric field. In case of a malfunction of the said devices, please cut off the power first, then relocate the devices and turn them back on.

Please place this product on a flat, level floor, with ample space (>10cm or 3" in) on all sides around the table to ensure adequate ventilation.

## REPAIR

It is strictly proh bited to disassemble or modify the table and damage the refrigeration pipeline by yourself. Maintenance of the table must be carried out by professional personnel.

## PLACEMENT ENVIRONMENT

- 1.Smart Coffee table should be placed far away from any heat source and do not expose to direct sunlight.
- 2.Smart Coffee table should be placed in a well ventilated area, please refer to TABLE PLACE-MENT CONDITIONS.
- 3.Do not place the smart coffee table in damp areas or where the equipment may come into contact with water. Do not place power sockets, voltage stabilizers, or small appliances on the refrigerator coffee table.
- 4.Do not put unstable objects on the smart coffee table to avoid damage to the table top.
- 5.Be cautious when placing objects with liquid on table. Spilling liquid can result in property damage, personal injury or electric shock.
- 6.Do not store gas or any other flammable materials in or near the smart coffee table to avoid possible fire hazard.
- 7.If there is any gas or other flammable material leak around the unit, close the gas valve and open all doors and windows immediately. DO NOT PULL OR TOUCH THE SMART COFFEE TABLE ELECTRIC PART.

## PLACEMENT OF POWER CORD

SUG 1. Please leave enough place for ground plug if your house is under decoration orrenovation.

Ground Plug set suggestion:

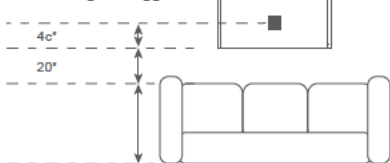

SUG 2. You can buy a carpet to hide the ground power cord.

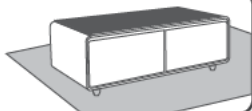

SUG 3. You can also use the attached cable cover to hide the power cord to avoid any tripping.

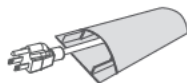

## INSTALLING THE POWER CORD

### GROUNDING INSTRUCTIONS

This appliance must be plugged into a grounded socket. The power cord that is supplied with the appliance contains the appropriate grounding conductor and grounding plug.

The plug must be inserted into a outlet that has been grounded in accordance with the existing local codes and ordinances. The required nominal voltage and frequency are indicated on the rating label. Consult a qualified electrician for other concerns.

1. Have one partner lift the right side of the Smart Coffee Table table off the ground. Rest the opposing side on a foam insert or cushion for protection.

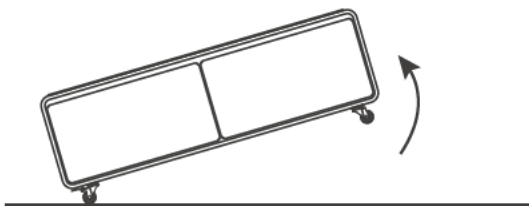

2. The power socket is located on the underside of the Smart Coffee Table towards the back right corner. Locate the socket and unwrap the power cord before attaching. Plug in the adaptor end of the cord to the socket in the indicated location below.

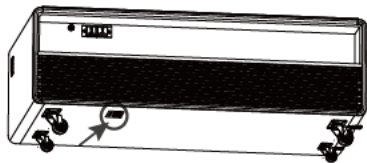

3. After installing the power cord or moving the Smart Coffee Table, you must let the refrigerator coolant settle for a minimum of 2 hours before plugging in the Smart Coffee Table.



Use proper lifting technique!

Exercise caution! If you have a history of back pain or injury do not attempt to lift table ARTISAN will not accept responsibility for any injury that may occur during set up process.

## FUNCTION AND FEATURES

Left Refrigerator Drawer 37.4°F~46.4°F

Right Refrigerator Drawer 42.8°F~53.6°F

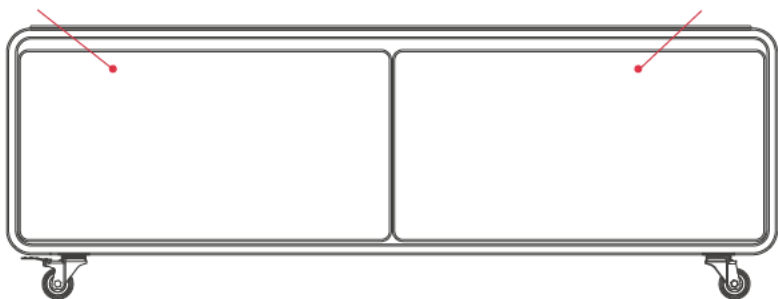

### REFRIGERATOR DRAWERS

The Smart Coffee table is designed with two drawers that can be independently controlled for the temperatures. Each refrigerator drawer comes with two partitions and one tray to organize all your favorite beverages and snacks.

### WATER INLET

This smart coffee table with built-in refrigerator is designed with a water inlet, enabling users to either have access to cool, soothing filtered water, or enjoy the convenience of automatic water feeding & boiling for daily tea making.

### CHARGERS

There are 3 types of chargers, one is 15W wireless charger located on the top, second is USB chargers and the third is TYPE-C chargers located on the right side, which can provide electric power to your phone anytime.

### 110V POWER SOCKETS

The smart coffee table is equipped with 110V power sockets, to supply power to other devices. The power sockets have a separate safety switch to detect high input or overload. If the safety switch detects either, it will cut off power automatically to avoid any dangerousness.

### HIGH EFFICIENCY COMPRESSOR

The smart coffee table is equipped with a high efficiency compressor to keep your unit working at optimum performance. It can automatically adjust the ON/OFF time according to the changes in temperature inside and outside the refrigeration compartment, as well as the amount of stored food. It has powerful refrigeration capability and it is environmentally friendly and energy-saving, and operates quietly.

### ■ **PARTITION STORAGE**

To make better use of the storage space, there are two partitions and a tray in the refrigerator drawer; which facilitate the classification and storage of food.

### ■ **REMOVABLE DOOR SEAL**

The removable door seal will ensure the long-term sealing of the Smart Coffee Table, making it easy for daily cleaning and maintenance, and reducing energy consumption.

### ■ **RGB ATMOSPHERE LIGHT**

The RGB light can both create atmosphere and provide illumination for the room, which is colorful and mild. It can perform dynamic changes as well.

### ■ **BLUETOOTH SPEAKER V5.0**

Equipped with Bluetooth v5.0 technology, the transmission distance is 10 meters. It can easily connect to cell phones, computers, laptops or your TV.

### ■ **TYPE-C CHARGER**

The Smart Coffee Table equip with type-c charger, which can satisfy users multiple charging demands.

### REFRIGERATOR DRAWER



#### NOTE

- 1.Fill this refrigerator only with fresh food.
- 2.Do not store food that requires the refrigerator to outperform its designed temperature range.
- 3.Do not store food while it is hot. This would drive up the drawer temperature, thus affecting all other items inside.
- 4.Do not open the drawers all too often, nor leave it open for a long time. This would also destabilize the inside temperature.
- 5.Do not store food that is about to expire. Keep food properly sealed to avoid odor build-up.

#### Storage Suggestion

- 1.The food should be washed and clean thoroughly before putting into the refrigerator.
- 2.The bottles should be closely placed to prevent tilting and falling when the door is opened.
- 3.Food placed in the drawer should not exceed a certain height, otherwise it may prevent the drawer from closing properly.
- 4.The partition can help organize different types of food, and can be adjusted according to your needs.
- 5.The sliding tray can be used for storing the washed fruits, (such as grapes and strawberries) without the need for a fruit plate.
- 6.Adjust the refrigerator temperature according to the food characteristics.

## CONTROL PANEL INSTRUCTION

The display area is divided into two parts. The refrigerator control area is above the horizontal line, the speaker operation area is below the horizontal line. Double-click the "Refri Unlock" button  on the refrigerator, allowing you to use other fridge buttons. Double-click the speaker unlock button  then you can use other speaker functions.

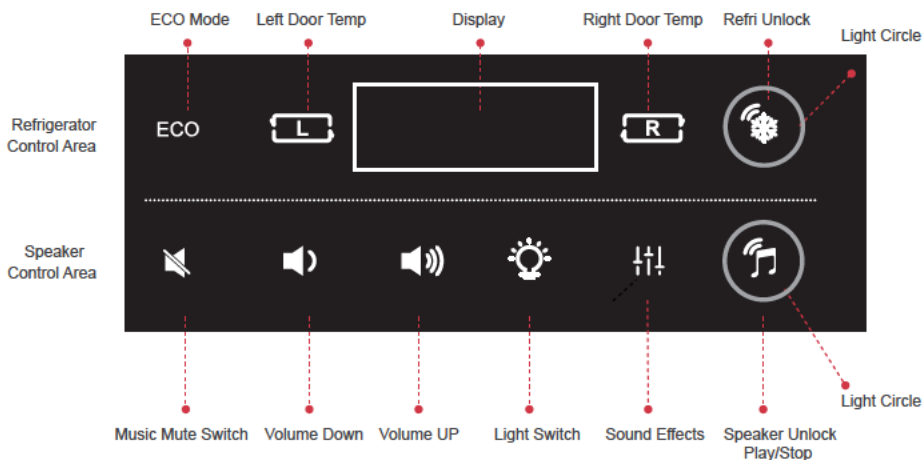

### NOTE

1. The refrigerator and speaker share the same controlling board. The controlling buttons for the refrigerator are above the line, the ones for the speaker are below.
2. When the temperature of the refrigerator has been adjusted and the speaker is set separately, the digital board will show the current operation of the speaker.
3. When the speaker mode is on, you can also operate the refrigerator by double-clicking the Unlock button to initiate the refrigerator.

The operation of the speaker and refrigerator does not affect each other. And the speaker can be turned on and off independently.

## REFRIGERATOR OPERATION

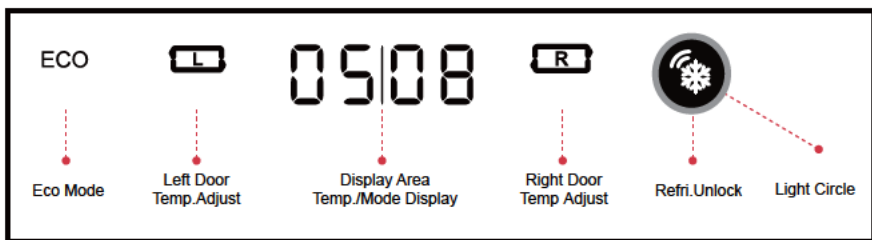



After the initial power-up, the refrigerator automatically enters unlock mode. If there is no operation in 10 s, the buttons will be locked

### REFRIGERATOR UNLOCK BUTTON

If there is no operation in 10s, the whole board will lock and all digital lights will turn off. All buttons except the UNLOCK button will stop working.

In lock mode, press the refri. double click lock button “” the refrigerator's buttons can be operated.

When the interval of double clicking on the unlock button “” is longer than 15s, it will be regarded as an operation error, leading to no response from the display panel. For normal use, double-click the unlock button “” again.

### RIGHT REFRIGERATOR

Once unlocked, touch the button “” and the current fridge temperature will flash to indicate that the right refrigerator is being operated. Each time the button is pressed, the right refrigerator temperature increases, cycling between 43 to 54 (“OF” means the right refrigerator is switched off). If the button is not pressed for more than 3 seconds, the setting is confirmed by default and takes effect.

### LEFT REFRIGERATOR

Left refrigerator setting is the same as the right one. The temp range from 37°F~46°F. The left display area shows the current temperature of the left refrigerator; and the same goes for the right display area.

### ECO MOD

When the refrigerator module is active, press the ECO button, the digital board will display “ECO” and the most energy-saving temperature of the right and left refrigerator drawer in the current environment. If no button operation is pressed for more than 2 seconds, the default setting will take effect.

### DOOR OPENING ALARM FUNCTION

When you open the drawer, the display screen will show the current temperature of the opened cabinet. If the door opens for a long time or is not closed properly, the alarm will go off to remind you to close it in time.

### POWER OFF MEMORY FUNCTION

When the smart table is powered off, the last working state will be memorized and applied to the refrigerator when the power is turned on.

### CLOSED STATE

Open the door of the drawer; the display screen can display the set temperature of the cabinet.

## SPEAKER INSTRUCTION

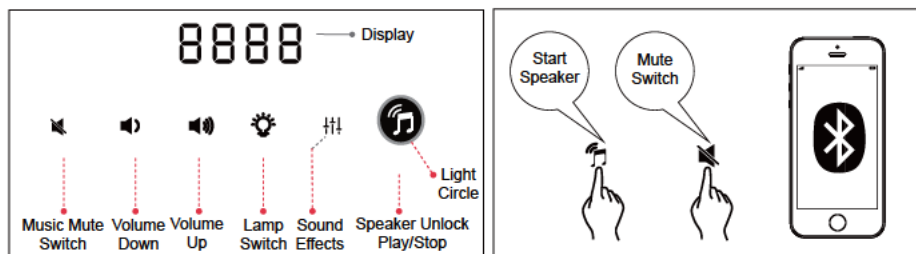



### SPEAKER

In off mode, click the unlock button “”, and the buzzer rings and the white aperture will be on, which means the speaker is switched on. At this time, all buttons of the speaker are activated.

### MUSIC PLAY

In Bluetooth mode, where the display area shows BL, broadcast saying “Bluetooth mode” will be played. You can turn on your mobile phone and search for blue tooth device “T-bar”, and select and connect it with the unit. If your phone need “paring mode”, please enter “0000” (It is no need to enter a password if the phone system version is advanced). When the connecting is successful, the speaker will be used as a external speaker for your phone. A voice will be played when the Bluetooth data transmission is disconnected. 5 minutes later, the Bluetooth connecting will be cleared and reset. When the Bluetooth transmission is interrupted, it will broadcast that the Bluetooth is disconnected. When it is more than 5 minutes, the Bluetooth connection will be cleared and reset. When your mobile phone is back in the connection range, it will be connected automatically.

### SOUND EFFECT

Double click the Speaker Unlock “” button, and then click “” button until desired preset sound effect option is displayed on the screen, the broadcast will also announce the select mode. The sound effect include: AUTO / POP / JAZZ / ROCK/ FILM.

### ATMOSPHERE LIGHT ON/OFF



Touch the button “” to turn on the atmosphere light, touch it again, the atmosphere light turns off.

### PAUSE OF MUSIC

There are 2 ways to pause music when playing music:

1. Directly control the pause and playback of sound through the equipment connected with external sound source.
2. Touch the “” button to mute the music.

### MODULATION

The total number of levels of volume is 16. Each time you press “” the volume increases by one level, and each time you press “” the volume decreases by one level.

Note: when the volume setting is completed, 2 seconds later, the nixie tube returns to display the current sound mode.

### SPEAKER OFF

Press and hold “” for 6s, during which, the nixie tube will display OFF for 1s and the circle will light up in 3s. The aperture nixie tube and the speaker will turn off, and there will be a prompt note when the speaker turns off.

### SPEAKER LOCKING

If there is no operation for 10s, the audio module will automatically lock down. After locking, its aperture will go out, but the nixie tube will always display the current audio mode. When locked, mute mode, sound effect, volume adjustment, atmosphere light and pause / play keys cannot be operated.

### 110V POWER

This table is equipped with two power ports, with a required rated current of 10A and a rated power of 960W. It can accommodate the use of both two-prong and three-prong electrical appliances.

#### CAUTION: DO NOT DROP WATER OR LIQUID IN ANY OF THE POWER OPENINGS.

Please do not connect to appliances that fail to match the required nominal voltage and frequency on the rating label. Please do not connect to a multipurpose power outlet.

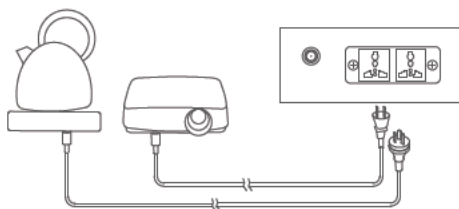

### MULTI PROTECTIONS / SLUtp:

Overload Protection	5000 times of plugging test	Shell with 750°C flame retardant	Double acting safety door	Hidden warning light	New national standard sockets
---------------------	-----------------------------	----------------------------------	---------------------------	----------------------	-------------------------------

### WIRELESS CHARGING

Wireless charger only works for devices that are equipped with wireless charging and meet the Qi standard.

#### NOTE

1. Wireless charging is enabled once the table has been plugged in.
2. Please put the device to the center of the wireless charging area.
3. Make sure there is no metal barrier between the charger and the phone to avoid overheating.
4. If the charging surface is overheated, please remove it and stop charging.
5. The wireless charger and USB charger should not be used at the same time, otherwise the USB charger won't be able to work.

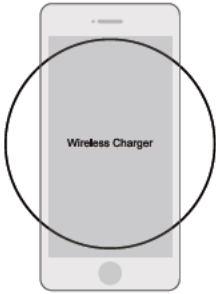

Voltage	12V Input
Output	15W (max)
Sensing Distance	≤ 4mm
Work Frequency	105K-205K Hz
Work Temperature	14°F-149°F
Work Humidity	10%RH-75%RH

## ■ USB-A AND TYPE C CHARGING

There are two USB-A and one TYPE C chargers that can connect devices to the speaker and charge device.

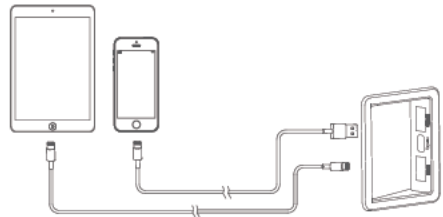
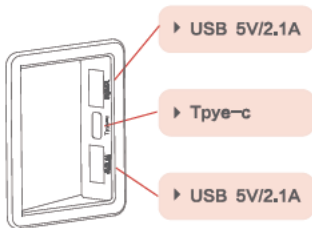

## ■ WATER SUPPLY FUNCTION

Easy access to ice water or hot tea right there in your living room has been made possible, with our special design of a built-in water supply system placed in the back of the table. As long as you have an automatic water filter or boiler, connect the power, and you can meet the daily needs of drinking cold water/hot tea on the coffee table.

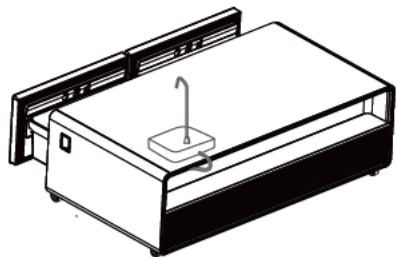
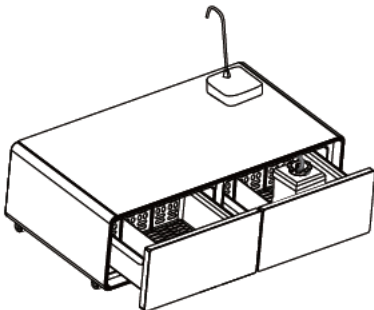
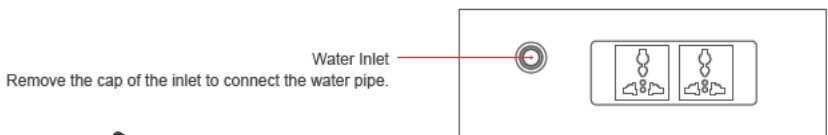

## DAILY MAINTENANCE

### CLEANING

Clean the Smart Coffee Table regularly to avoid dust accumulation. Wipe the surface of the table with the microfiber cloth. Do not store expired food in the drawers.

1. Before cleaning the Smart Coffee Table, please make sure to turn off the power and remove the plug.
2. Please do not forcefully disassemble this table, as it may cause damage.
3. Clean the unit with a soft cloth and neutral detergent. Dry the unit with a clean and soft cloth.
4. Clean the shell gently to avoid deformation or short circuit caused by the water flowing into the device through the mesh.
5. Inspect the unit after cleaning. Do not use if any damage is found.
6. Make sure the table is completely dry before powering on.

NOTE: Be sure to clean the door seal thoroughly to ensure a long lasting period and preserve power consumption.



### NOTE

In order to prevent leakage accident, do not spray water to wash the table. Please use dry cloth to clean the power socket, knob, plug and USB socket.

In order to prevent damage to the unit, please do not use following material to clean the table:

1. Acidic or slightly alkaline kitchen cleaners.
2. Similar powdered detergent products.
3. Chemicals such as benzene, sodium bicarbonate, alcohol, carious acids, petroleum.
4. Hard brush, abrasive sponge brush.
5. Hot water.

Due to the substantial weight of this table, please be cautious and avoid any scratch or damage to your floor when attempting to move the table for either cleaning or maintenance. Always keep the tempered glass top upright while doing so.

Please do not use hot water to clean the inside of the drawers including the glass shelves, partition panels or PET trays. Drastic temperature differences might cause fracture, breakage or explosion of the above, resulting in personal injury and property loss.

Please do not touch the inside of the drawers with wet hands while cleaning. Do not reach your hands underneath the bottom of the table, as the metal components might accidentally cause scratch or cut.

## ■ DISASSEMBLY AND CLEANING OF THE REFRIGERATOR DRAWER

Before dismantling the refrigerator drawer, please take out the PET tray, drawer partition and all items inside from the refrigerator. Fully pull the door and the drawer, lift up the whole drawer and pull out the sets.

You can use water to wash the drawer, PET tray, partition, and then use soft cloth to dry them.

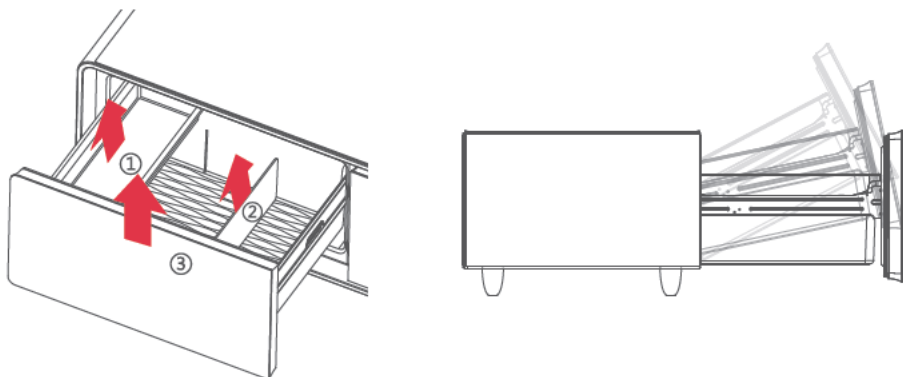

## ■ DEFROSTING

The refrigerator can defrost automatically, The defrosting water flows out to the water tray at the back of the table through the bottom back of the water tank. The water will be evaporated naturally by the heat of the compressor.

## ■ DOOR SEAL CLEANING

The doors and door seals of smart coffee table can become dirty and easily lead to aging and damage. This can cause the door to not close properly and result in air leakage, so it is important to keep them clean. When cleaning the door seals, it is necessary to use clean water and wipe them dry with a dry cloth.

## ■ SAFETY INSPECTION AFTER CLEANING

1. Please check if the power plug is completely inserted into the socket.
2. Please check if the power cable has scratches.
3. Please check if the power plug has abnormal heating condition.
4. Please check if the power base and USB has foreign object or liquid left.

## DELIVERY AND OUTAGE

### TRANSPORTATION

1. Unplug the product.
2. Take out all the items inside the Smart Coffee Table.
3. Use adhesive tape to secure the partition and PET tray inside the Smart Coffee Table.
4. Close the drawer and use adhesive tape to secure it.



Do not lay down the refrigerator at any time. To avoid affecting the refrigerate system, The maximum inclination angle should be less than 45° during delivery.



### POWER OUTAGE

Even in summer, the temperature in the refrigerator can keep 1-2 hours after power outage. Please do not put more food into the unit and do not open the door when power off. You can put some ice with a container in the drawer if you had known about the outage.



An increase in the temperature of the refrigerator due to power outages or other failures can shorten the shelf life of food and affect its quality.

### POWER OFF

If the refrigerator will not be used for a long period of time, please unplug and cut off the power, and clean the unit. Please keep the door open to avoid any bad odor created by the food debris.



After unplugging the power cord, please wait for at least five minutes before plugging it back on. To extend the lifespan of the product, avoid opening and closing the drawers too frequently. If you want to dispose of this item, please properly disposed of or handed over to professionals for disposal. Do not dispose of it casually to avoid harm to the environment or other hazards.

### GO OUT FOR HOLIDAY

1. Cut off the power
2. Take out all the food inside the unit.
3. Clean the unit properly.

## NON-FAILURE

1	Foggy condensation on the surface: In rainy season with high humidity, condensation may occur on the surface of the refrigerator, which is not a malfunction, please dry it with a clean cloth.
2	"hissing" sound occur: This is the flow water sound of the refrigerate, which is normal phenomenon.
3	Compressor can not be started: The voltage is too low, please stop powering on the refrigerator and wait the voltage to get back to normal.
4	Long boot time: In summer, it is normal to start the device for a long time due to the indoor high temperature.
5	"Papa" sound: It is caused by thermal expansion and contraction of the inner tank and refrigeration pipe.
6	"humming" sound: When the refrigerator is working, the compressor will produce "humming" sound. If the device is not placed on a flat surface, vibration and noise will occur, just adjust the feet of the device according to the manual.
7	Wireless charger can not work: The charger of mobile phone can not meet the standard. Please make sure the phone charger meet the Qi standard.
8	Delay charging of the wireless charger: Please check the phone to make sure it places on the right area and remove the shell of the phone.
9	110 V plug can not work: Please make sure there is no water or foreign object in the socket. Check the refrigerator whether is connected properly and whether the switch on the right socket is turning on or not. If still doesn't work, please contact the after-sales service.
10	USB can no longer work: Check the refrigerator whether is connected properly and whether the switch on the right socket is turning on or not. If still doesn't work, please contact the after-sales service.
11	Refrigerator bottom is wet: Please check if the outlet hole is blocked.
12	The compressor runs continuously for a long time: Please check if the setting temperature is too low, the door of refrigerator is left opening for a longtime, hot food has put inside, the refrigerator is exposed to direct sunlight or there is too much food in it to influence the air circulation.
13	Bluetooth connection failure: Please refer to the specifications or user manual of your audio source device (phone or computer) to confirm whether the device supports A2DP. If so, please turn on A2DP mode. The table, by default, would stay connected to the first successfully paired device. If you wish to pair with a new device, you need to disconnect the Bluetooth mode of the first device before connecting to a new one.
14	Speaker doesn't work: Check both the volume of the audio input device and the volume of the speaker to see if they need to be turned up.

## TROUBLE SHOOTING

Fault	Causes	Solutions
Power light is on, compressor is working but making "humming" sound.	Power Voltage is lower than 90V.	Stop powering on the refrigerator and wait the voltage to get back to normal.
Compressor starts but stops after about one minute, and then starts and stops ongoing.	Power voltage is higher than 120V	
Compressor runs for a longtime, but evaporator surface is frost free.	Leak	Professional inspection is required.
	Blockage	Professional inspection is required.
There is frost on the surface but the compressor is keep working.	Too much frost on evaporator.	Defrost.
	Opening the drawers for a longtime.	Do not open drawers frequently.
	Drawers are filled with too many items.	Remove some of the items inside.
	Bad heat dissipation of condenser	Move to a ventilated area.
	Bad heat dissipation of condenser	Professional inspection is required.
The refrigerator doesn't work and refrigerated.	Fuse is blown and the power light is off.	Replace fuse.
	Input controlling circuit has fault and the power light is off.	Professional inspection is required.
Excessive noise	Machine places uneven.	Adjust the feet of the refrigerator.
	Inner fastener is loose.	Secure the fastener.
	Collision between pipes.	Separate the pipes.
It can refrigerate but when touch the surface, there is a slightly hemp and the electroprobe test with a light bright.	Induced electricity is leaking.	Check the earthing conductor.