

Assembly Instruction

2 DOOR WARDROBE

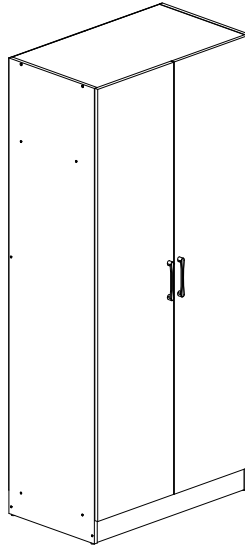

IMPORTANT

PLEASE READ BEFORE YOU CONTINUE FURTHER WARNING, CARE AND MAINTENANCE

- Please keep the original packaging until the item is fully assembled and in place. In the unlikely event that you need to return your product, it must be returned in its original packaging to avoid further damage. Failure to comply will result in rejection of the return.
- Important: Keep this page for future reference.
- Due to the size of this product, we recommend that it is assembled in the room intended for use.
- When you are ready to start, make sure that you have the right tools, plenty of space which is clean and dry for assembly.
- Unwrap all packaging materials and place the components on top of the carton box or on a clean floor to prevent scratches on product or floor.
- Check that all parts and hardware are present.
- Ensure that this product is fully assembled as illustrated before use.
- Tools not included.
- Ensure all screws and bolts are tightened and inspect regularly.
- This product should be used on firm level ground.
- Keep small parts out of reach of children.
- Make sure the legs are always in contact with the ground.
- Do not use power tools to assemble this product.
- Do not over tighten screws and bolts.
- Do not use this product if parts are missing, damage or worn.
- Do not sit and stand on the product.
- For general cleaning, use a dry, soft cotton or micro fibre cloth, and do not use detergents of any kind.
- Never use scourers, abrasives or chemical cleaners.

Assembly Instruction

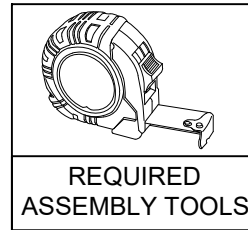
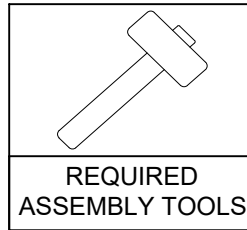
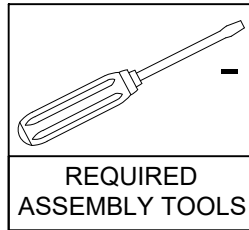
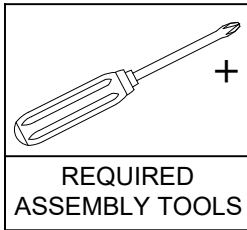

(TOOLS NOT PROVIDED)

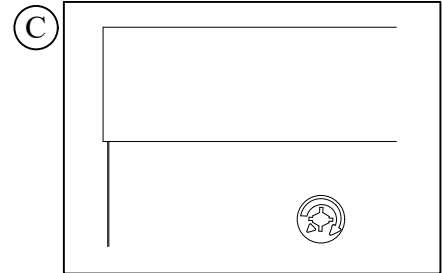
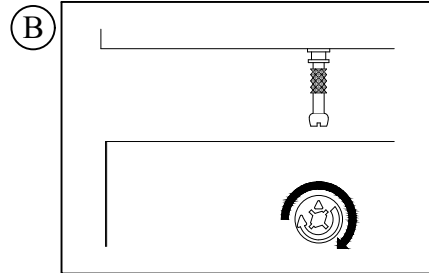
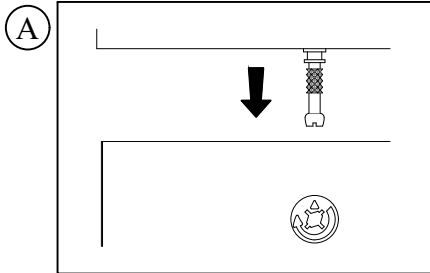

**Use a screwdriver to tighten the cam nuts as the sequence above.
A quarter turn clockwise is all that is needed.**

This is how a cam nut works:

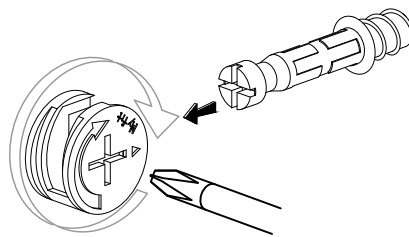

The head of the cam bolt goes into the open mouth of the cam nut.
You then turn the cam nut so it tightens over the bolt.

TWO PERSONS REQUIRED TO ASSEMBLE THIS PRODUCT

1. Please check that you have all parts listed before you start assembling. If you do find that something is missing, do not continue assembly. Please contact your supplier immediately.
2. Lay out all of the components on a soft surface as if you were preparing to do jigsaw puzzle.
3. Separate and identify each component from the hardware pack and rest each one in its proper location before fastening.

Assembly Instruction

2 DOOR WARDROBE

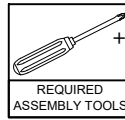

REQUIRED ASSEMBLY TOOLS

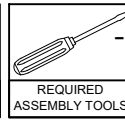

REQUIRED ASSEMBLY TOOLS

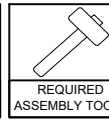

REQUIRED ASSEMBLY TOOLS

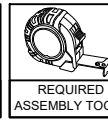



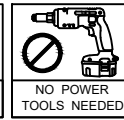



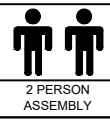





REQUIRED ASSEMBLY TOOLS



NO POWER TOOLS NEEDED



2 PERSON ASSEMBLY

1  6 x 25mm 18pcs	2  TP 10#x1/2" Screw 12pcs	3  3.5 x 14mm 28pcs	4  4 x 32mm 4pcs	5  M6 x 40mm 18pcs	6  15MM Screw Cap 18pcs	7  7a 7b 5/8" (Out) 6 Sets	8  Cylinder Pipe 1pc	9  V-Bracket 2pcs	10  2838 PVC Handle -128mm 2pcs	11  Nail Leg 4pcs	12  Nail 52pcs	13  Allen Key M4 1pc
--	---	---	--	--	--	---	--	--	--	---	--	--

PART LIST

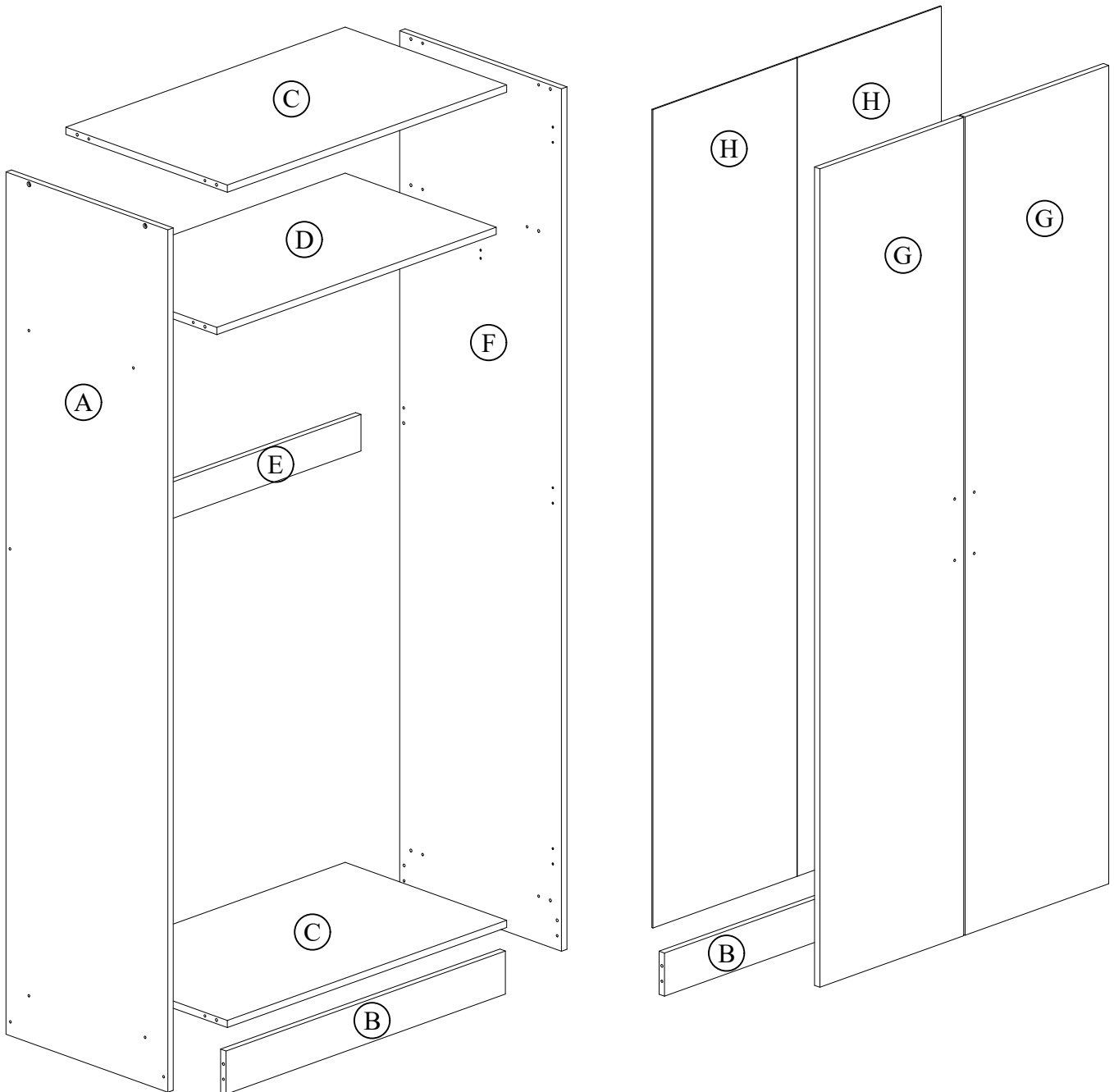

Assembly Instruction

Step 1

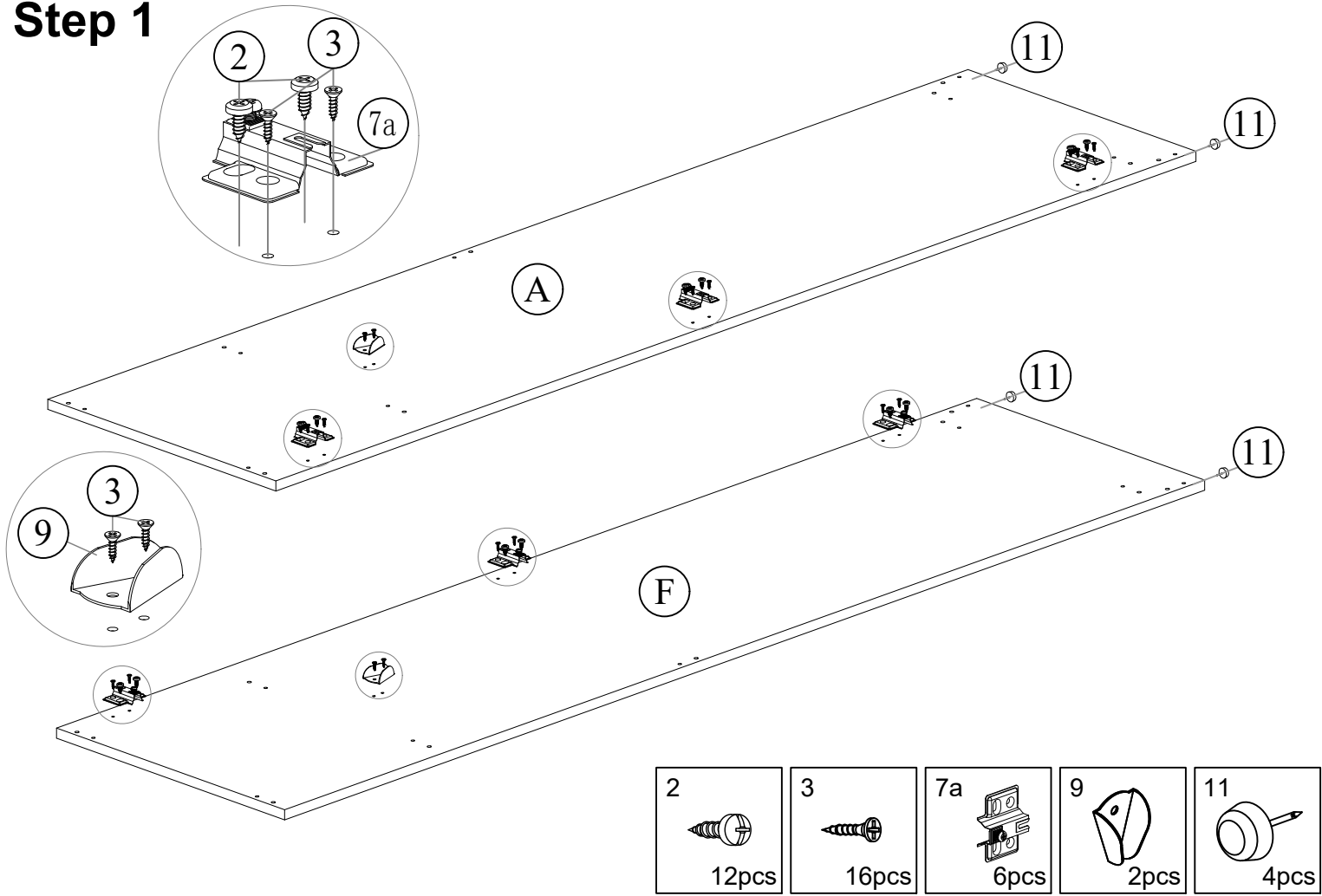

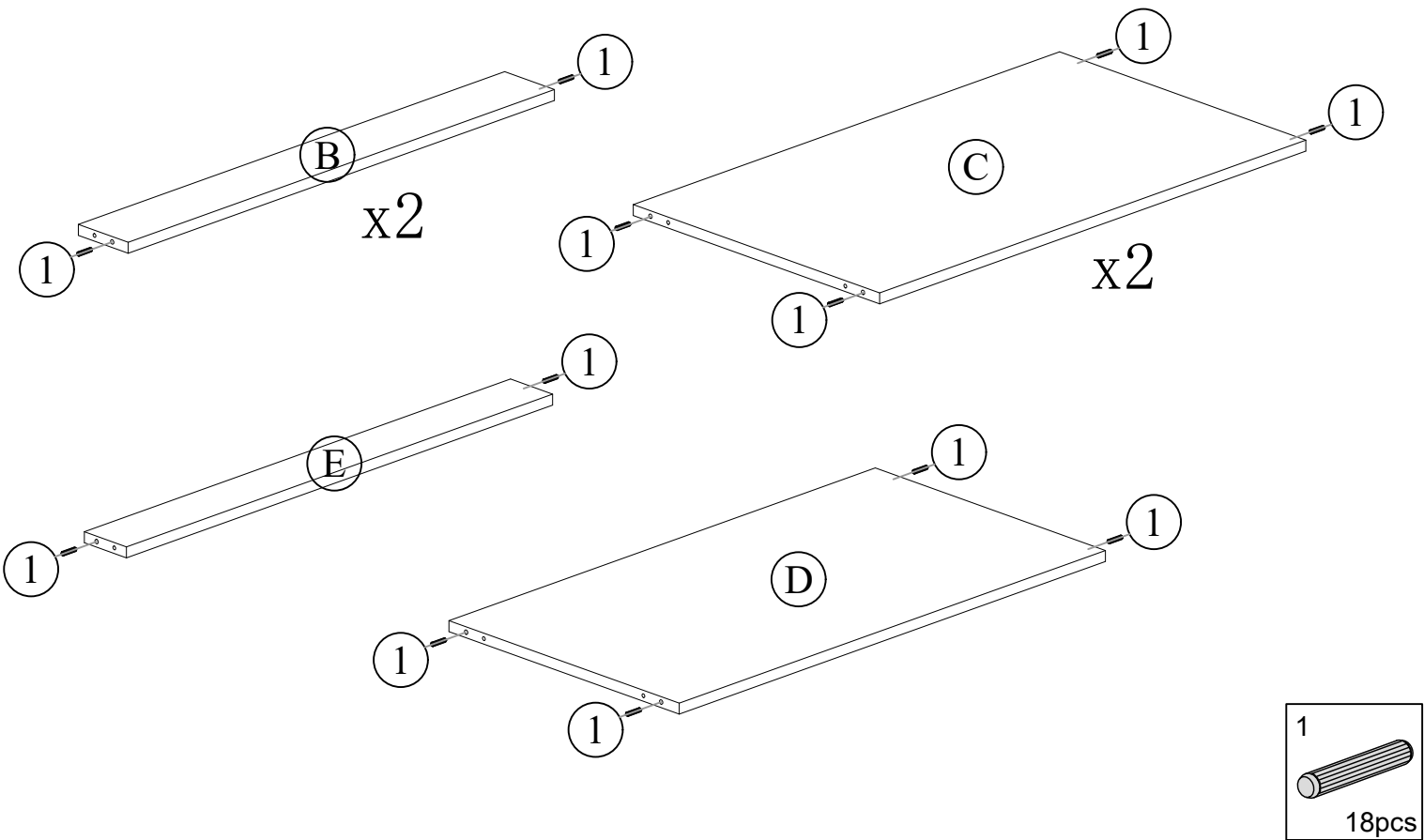

Step 2

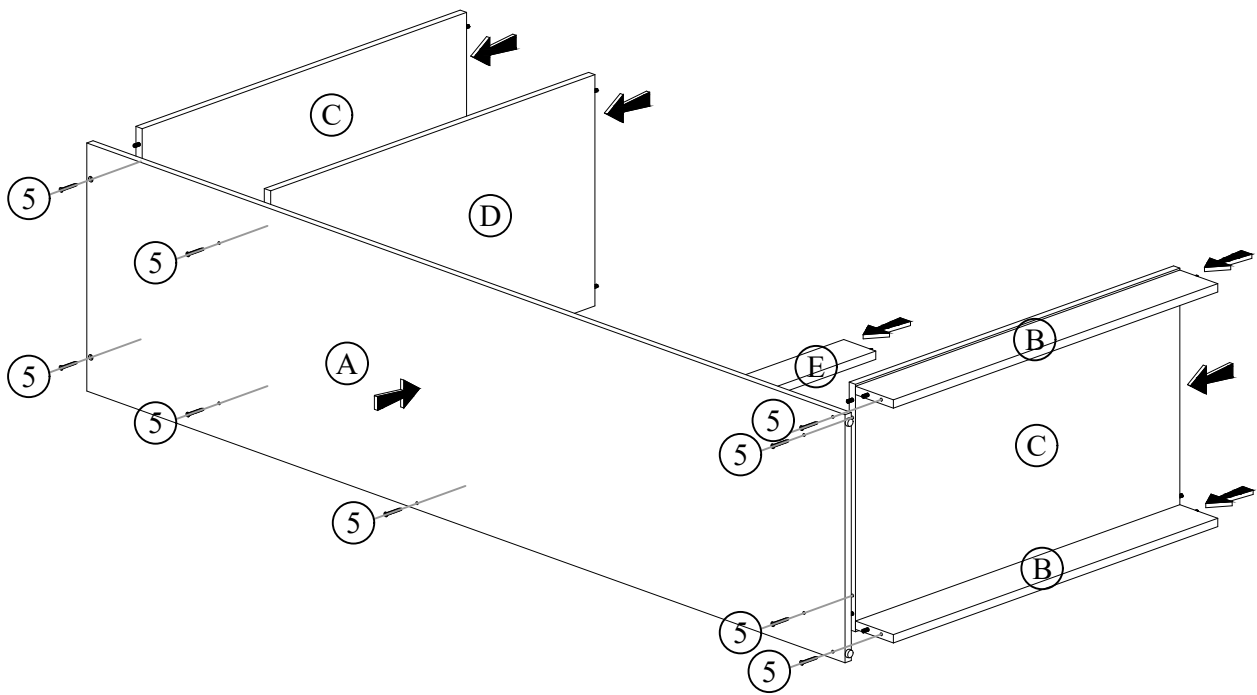

Assembly Instruction

Step 3



 **Step 4**

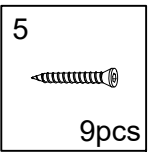

Step 4

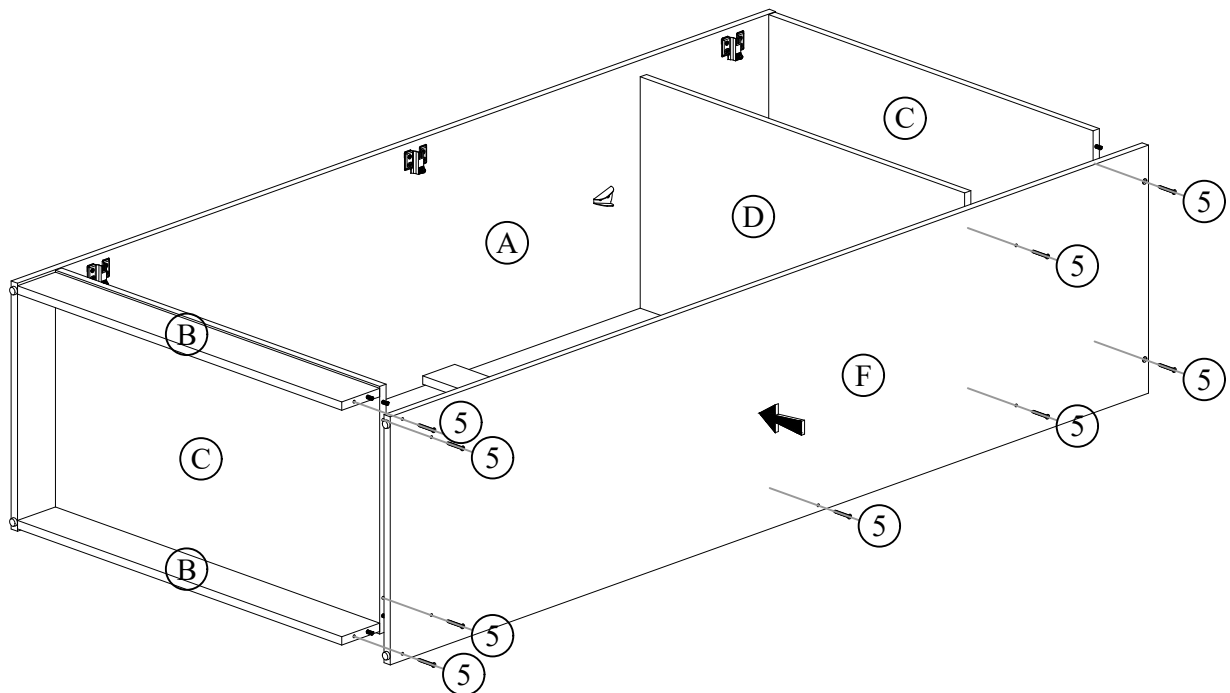

 **Step 6**

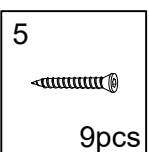

Assembly Instruction

Step 5

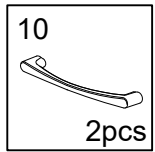
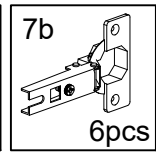
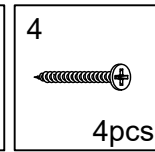
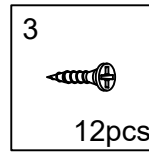
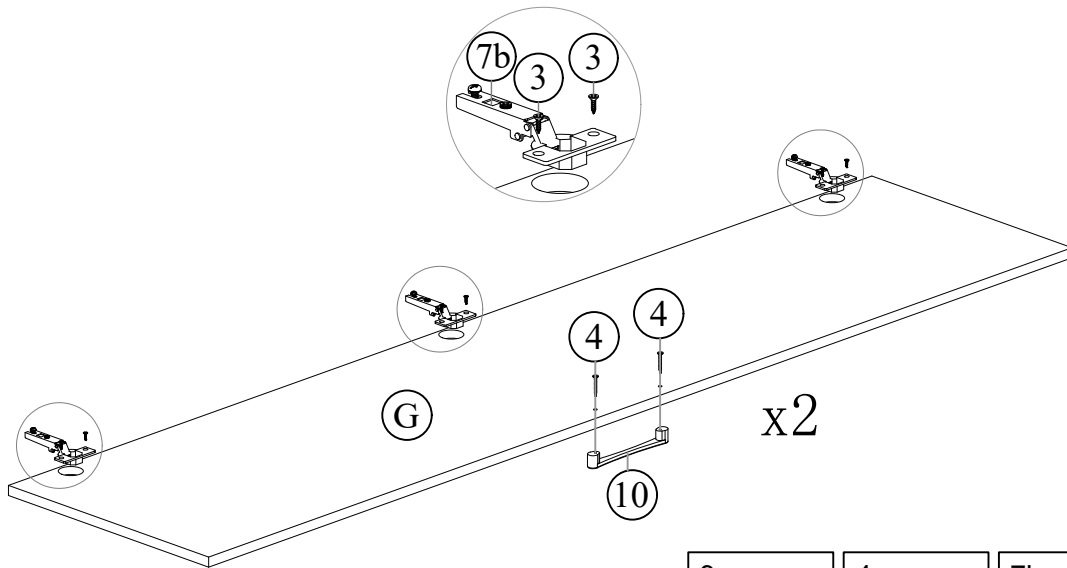

Step 6

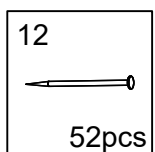
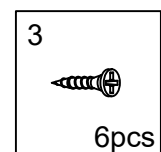
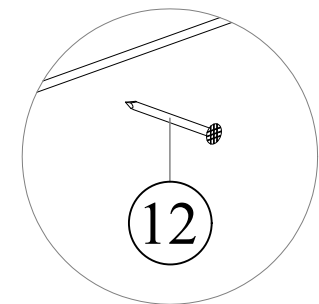
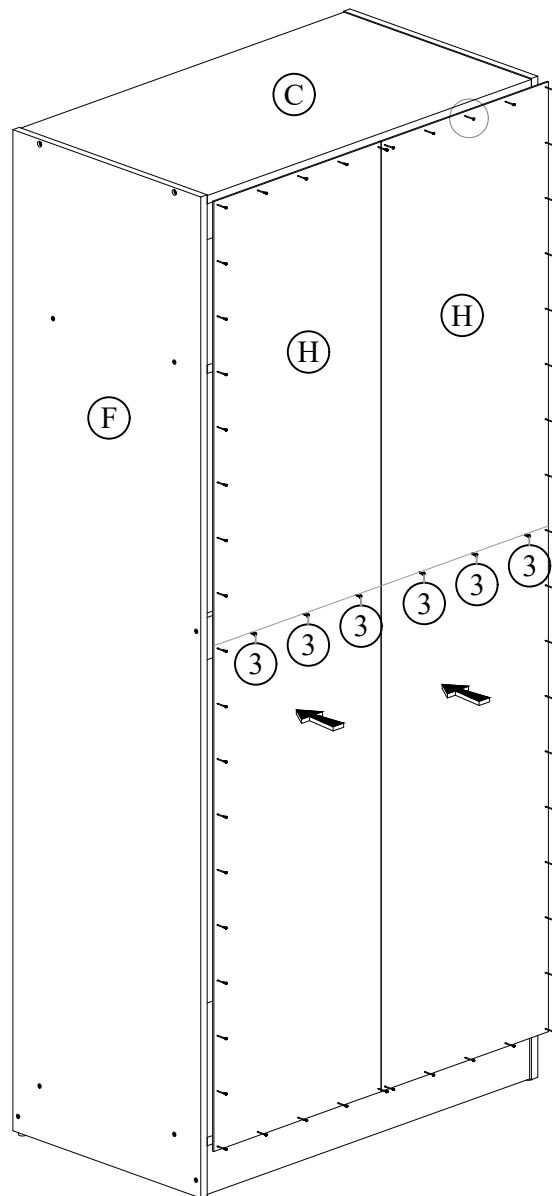

Assembly Instruction

Step 7

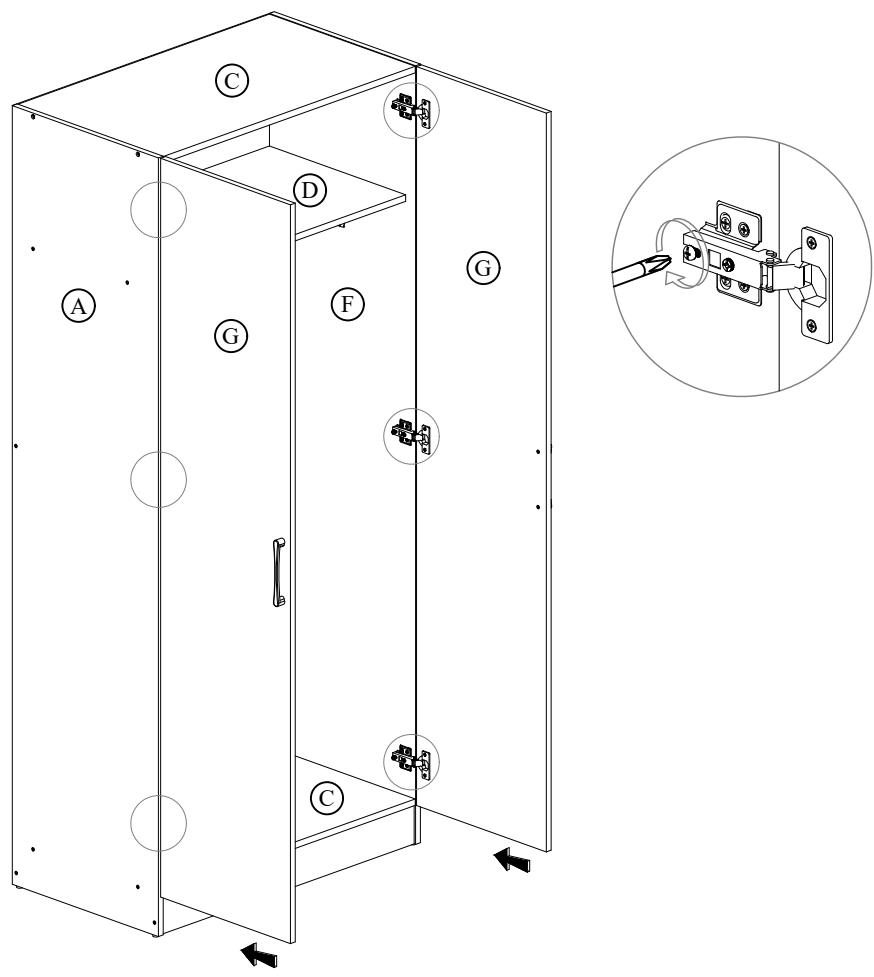

Step 8

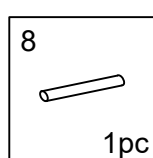
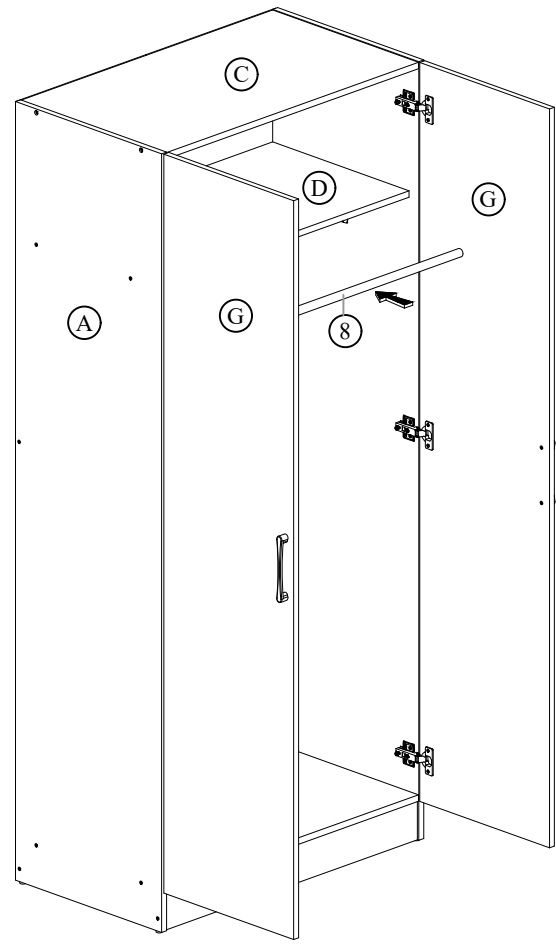

Assembly Instruction

Step 9

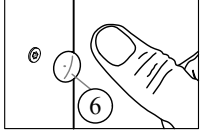

* Cover all the screw ⑤'s head with the pvc cap provided by pushing the cover's stem onto the hole of screw head.

Complete

