

# ASSEMBLY INSTRUCTIONS

DESCRIPTION : DINING TABLE

## IMPORTANT NOTE

**\*\*PLACE ALL PARTS ON A CLEAN AND SMOOTH SURFACE SUCH AS A RUG OR CARPET TO AVOID THE PARTS FROM BEING SCRATCHED**

**\*\*BEFORE YOU BEGIN, KINDLY FOLLOW THE ASSEMBLY INSTRUCTIONS STEP BY STEP**

**\*\*DO NOT TIGHTEN ALL SCREWS AND BOLTS UNTIL THE TABLE IS FULLY SET-UP**

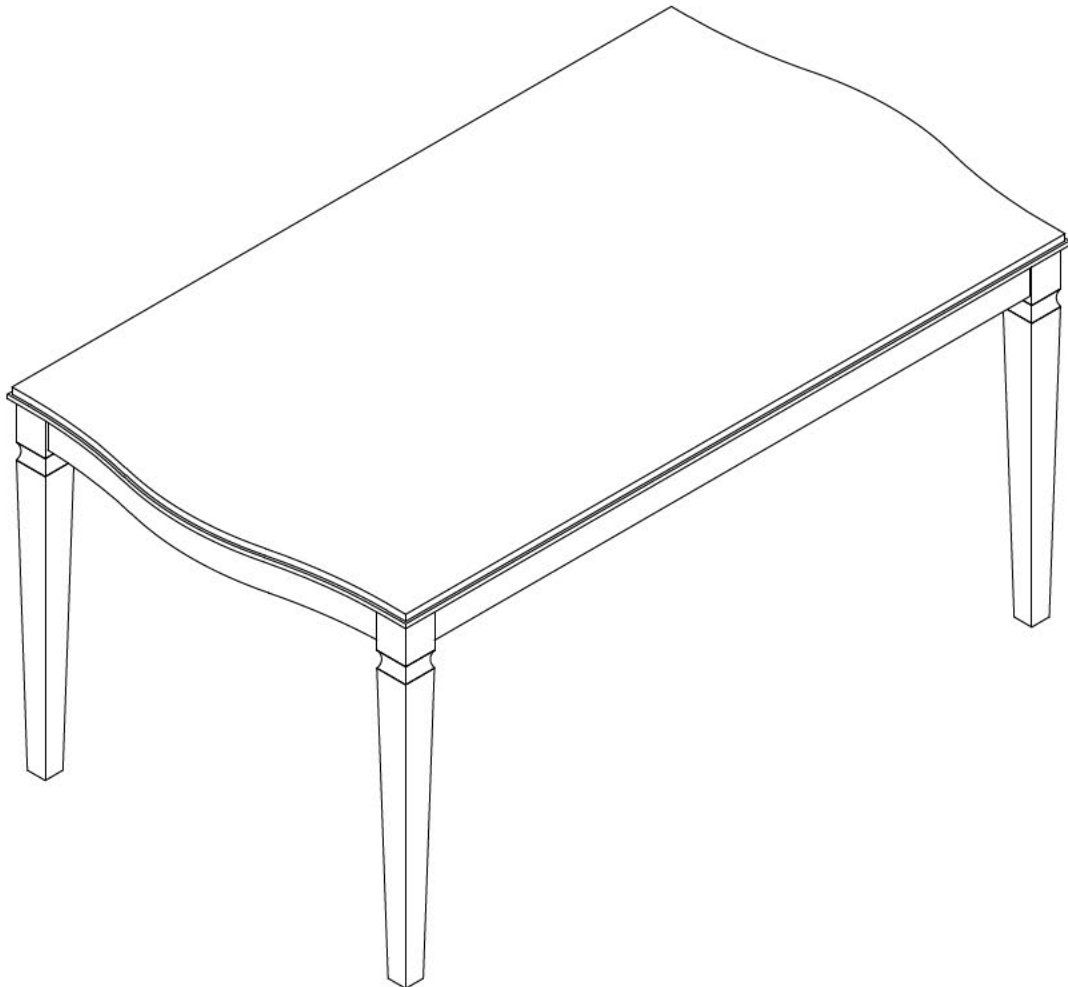







**PLEASE DO NOT RETURN PRODUCT TO THE STORE**

# ASSEMBLY INSTRUCTIONS

DESCRIPTION : DINING TABLE

## CARTONS ONLY ONE / HARDWARE LIST

PART LISTS				HARDWARE LIST			
NO	DESCRIPTION	SKETCH	Q'TY	NO	DESCRIPTION	SKETCH	Q'TY
Ⓐ	TOP TABLE		1 PC	①	BOLT Ø5/16*50mm		8 PCS
				②	WASHER Ø5/16"*19mm		8 PCS
Ⓑ	LEGS		4 PCS	③	SPRING WASHER Ø5/16"*11mm		8 PCS
				④	ALLEN KEY M4*60mm		1 PC

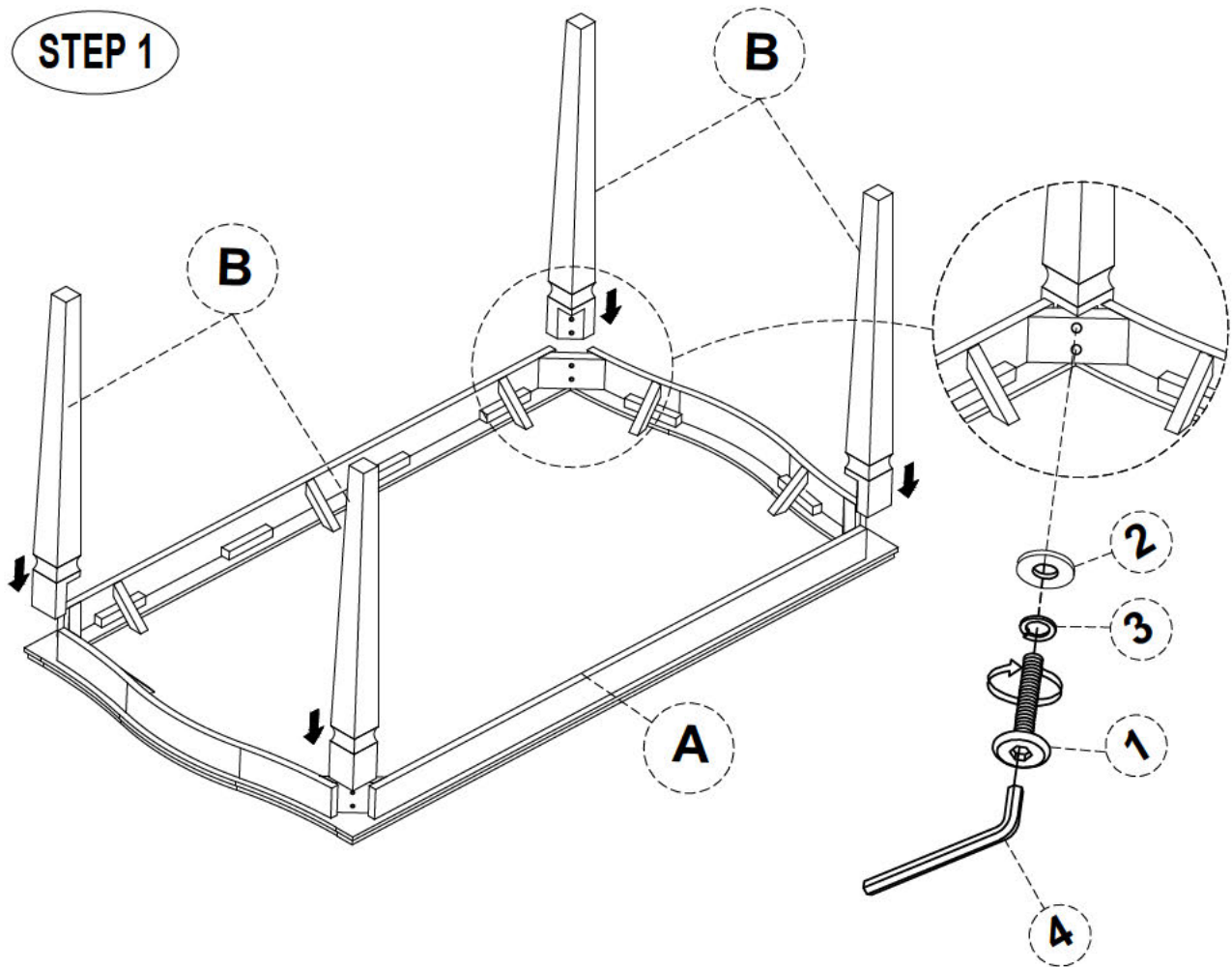

# ASSEMBLY INSTRUCTIONS

DESCRIPTION : DINING TABLE

**COMPLETE**

