

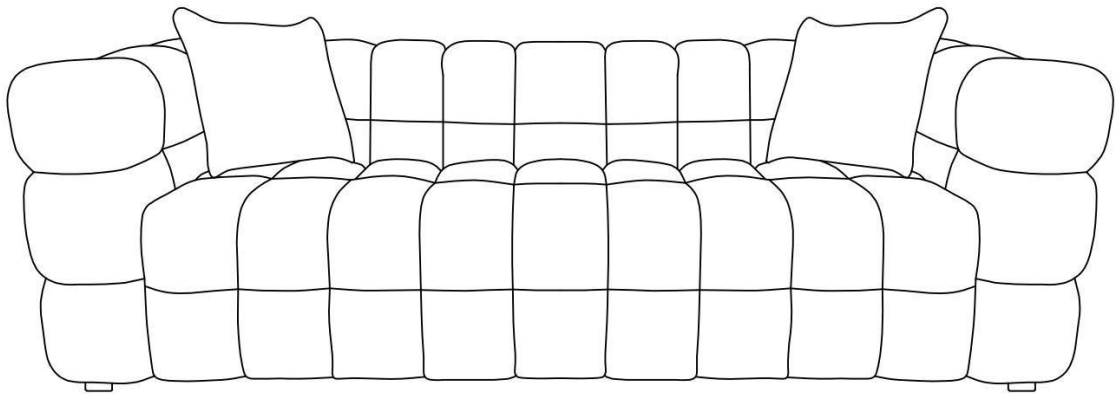

# ASSEMBLY INSTRUCTION

## SOFA

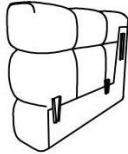
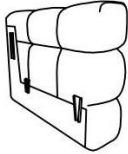
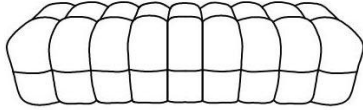
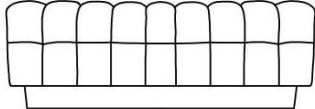

# PART LIST

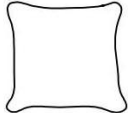
No.	Picture	Description	QTY
AL		Left Armrest	1
AR		Right Armrest	1
B		Seat	1
C		Backrest	1
D		Leg	5
E		Pillow	2

# Assembly Preparation

Before Beginning  
Assembly:

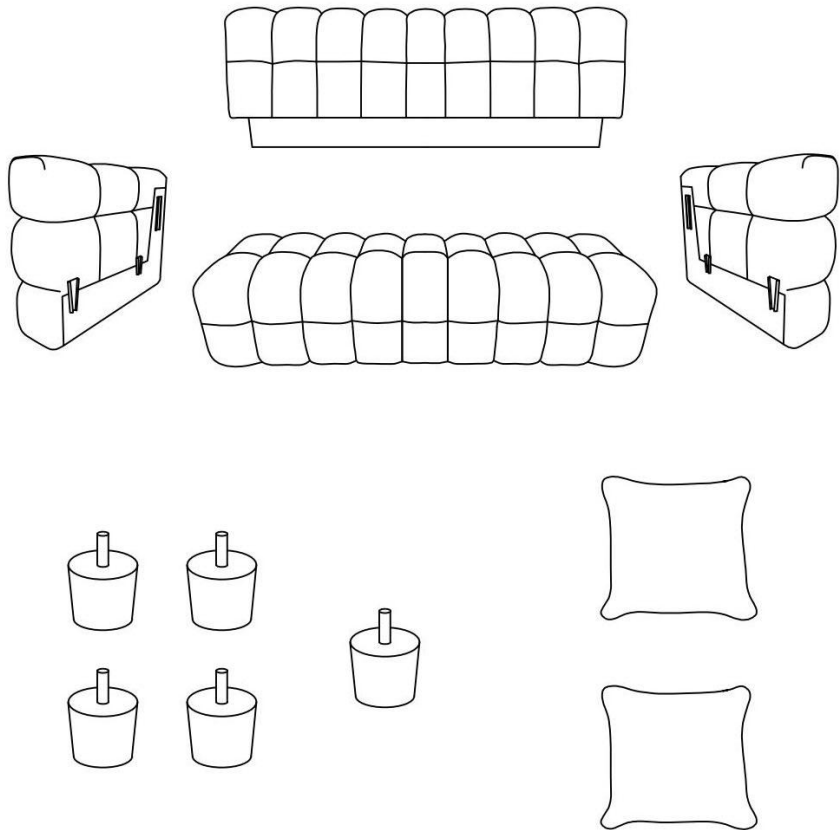

● Read instructions, cover to cover.



● Have 2 adults on hand for assembly.



● Do not assemble on flooring or carpet.



● Assemble on a clean non-marring surface (packing foam).



● Save all packaging until finished.

## Step1

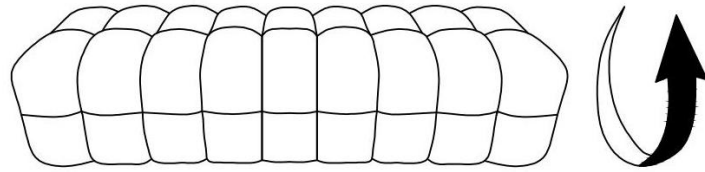

Turn the Seat over to face the bottom.

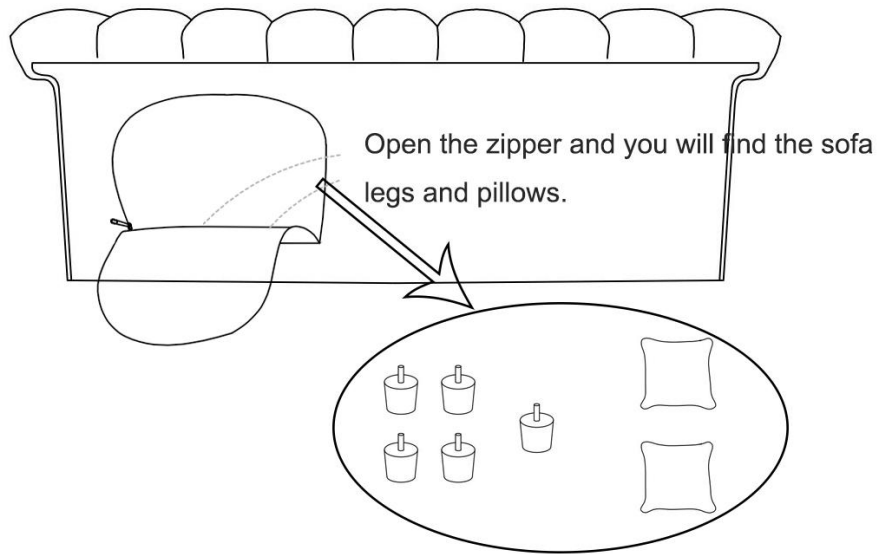

## Step2

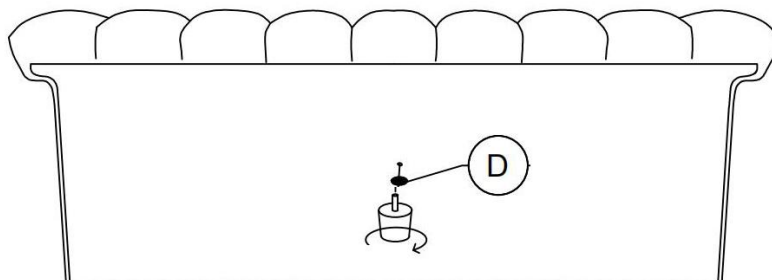

Rotate and screw the sofa leg into the pre-built screw holes.

### Step3

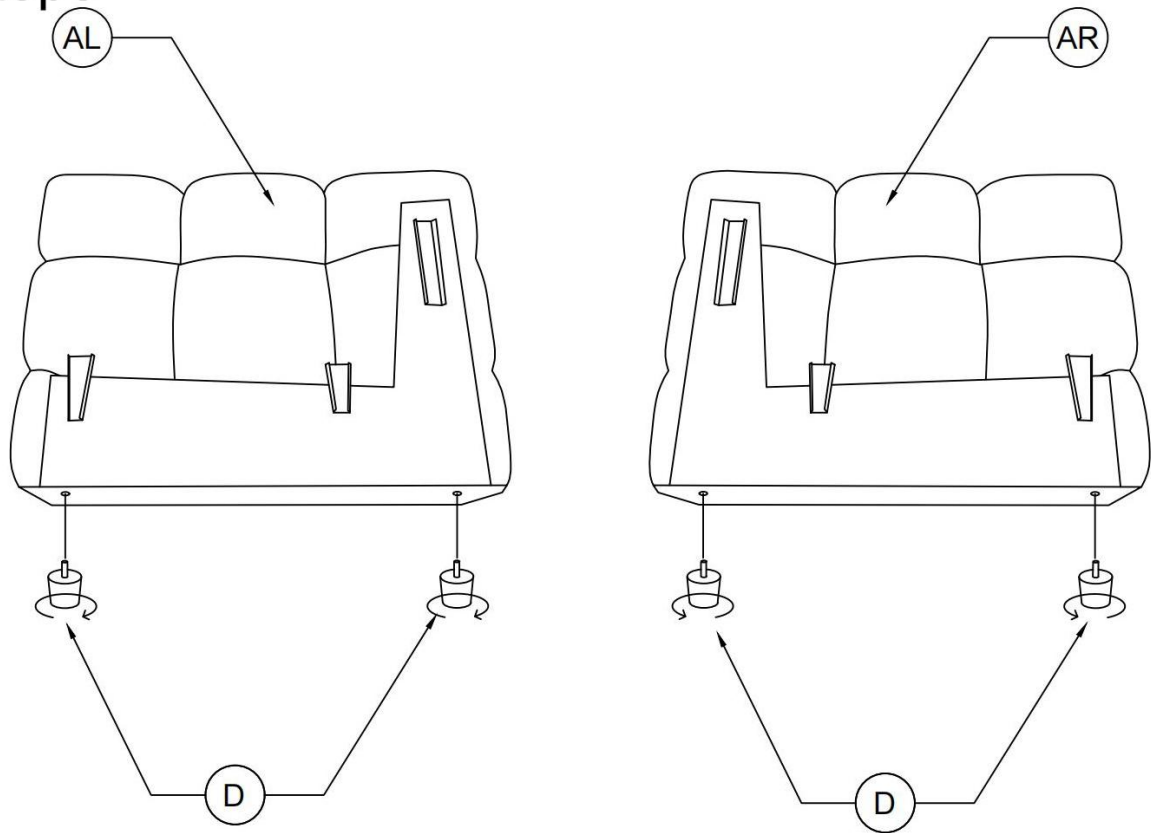

### Step4

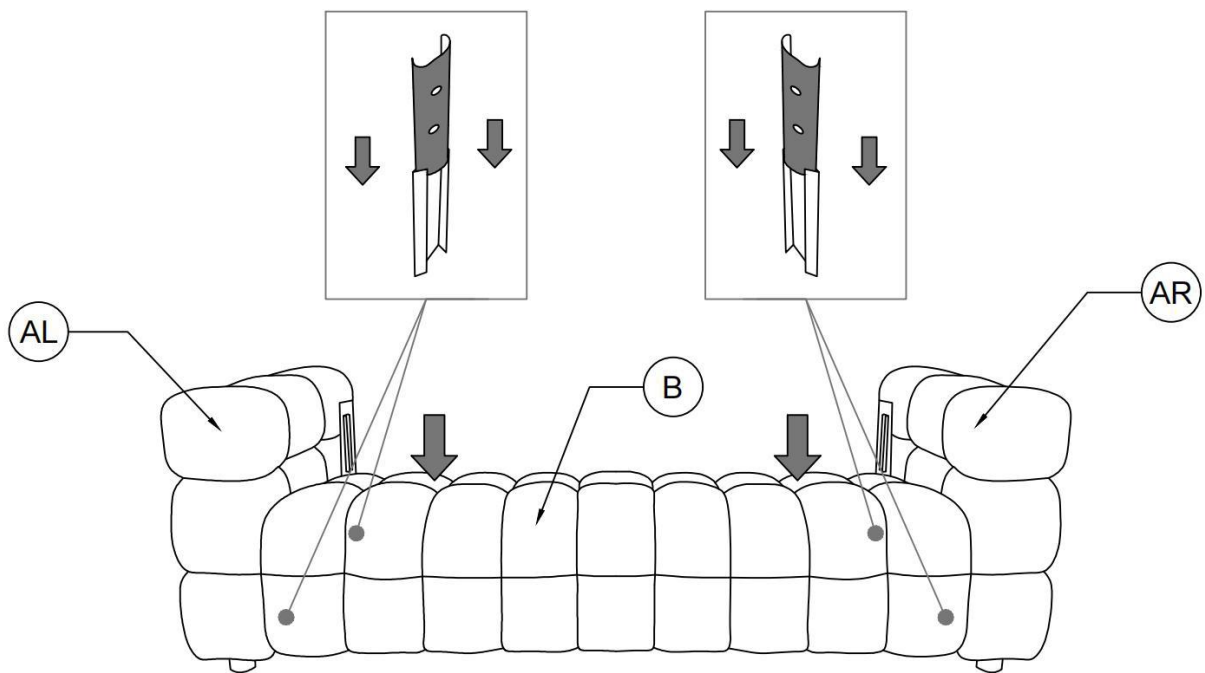

## Step5

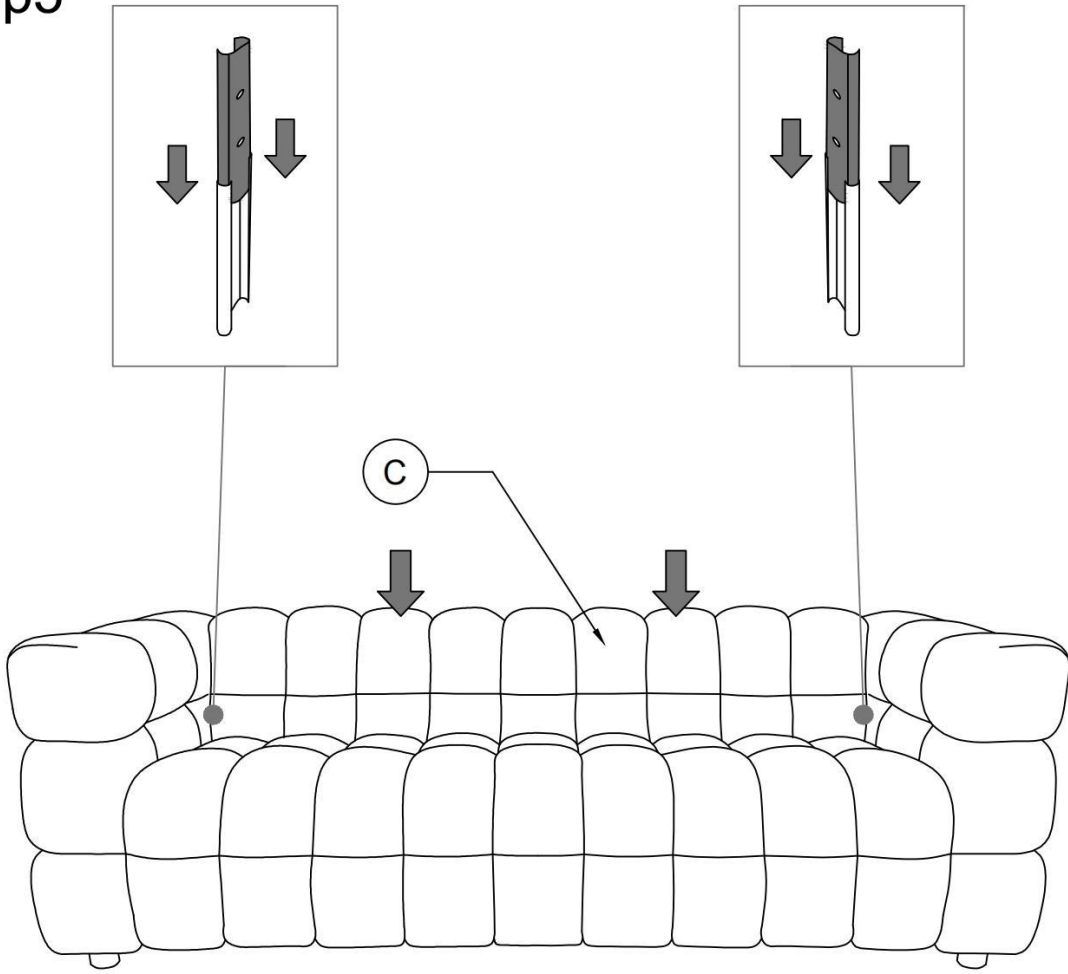

## Step6

