

Assembly Instruction Sheet

Tools Required: Flathead screwdriver, Phillips screwdriver, pliers, wire cutters, wire strippers, electrical tape, safety glasses.

Light Source: (1) A19 Medium Base bulb 100W Maximum, Medium Base G40 Vintage bulb is recommended, bulb not included.

Estimated Assembly Time: 20-30 minutes

Preparation: Identify and inspect all parts before beginning installation. Check package content list and diagrams below to be sure all parts are present. If any parts are missing or damaged, do not attempt to assemble, install, or operate the fixture. Contact customer service for replacement parts.

⚠ Warnings and Cautions

Turn off electricity at circuit breaker or main fuse box before installation. Consult a licensed electrician if in doubt.

These instructions are provided for your safety. It is very important you read them completely before installing the fixture. We strongly recommend that a licensed, professional electrician perform the installation.

Disconnect fixture from power source before replacing bulbs. Make sure bulbs are given sufficient time to cool before removal.

Package Contents

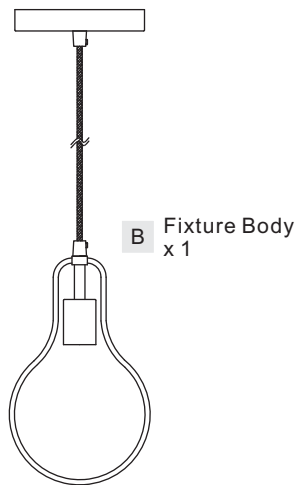
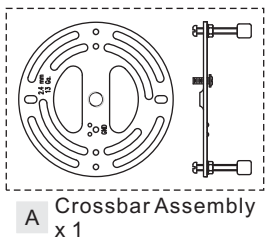

(Step 1 Continued)

achieved. Move the safety clip next to the hex nut inside of the ceiling canopy.

STEP 2 – Installing the Crossbar Assembly

A. Pass the supply wires from outlet box through the Crossbar Assembly (A). Attach the Crossbar Assembly (A) to the outlet box with the head of the green ground screw facing you. Secure the Crossbar Assembly (A) with outlet box screws (not included). Tighten until snug.

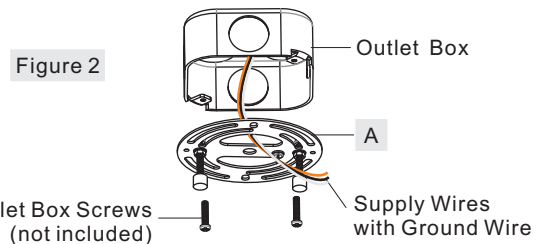

STEP 1 – Adjust Fixture Height

- Loosen the set screw on the coupling. Adjust the safety clip to proper location to make sure there is enough distance to adjust the cord in or out of the ceiling canopy according to your desired hanging height.
- Tighten the set screw on the coupling once your hanging height is

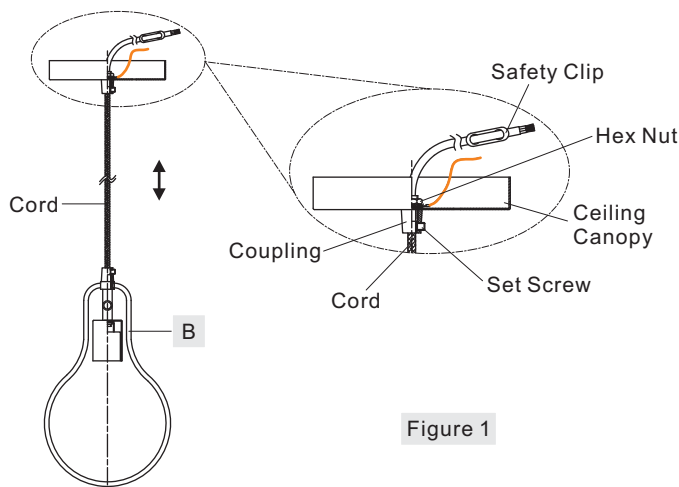

STEP 3 – Test Fitting Ceiling Canopy to Crossbar Assembly

A. Remove mounting balls from the Crossbar Assembly (A). Fit the ceiling canopy and Fixture Body (B) to the Crossbar Assembly (A) and secure with mounting balls. Note: The ceiling canopy should be snug against the ceiling and the mounting balls. If not, adjust the length of the nipple on the Crossbar Assembly (A) by unscrewing the preassembled hex nut and lock washer and then screwing the mounting screws in or out of the crossbar until the correct length is achieved. Once the ceiling canopy and Fixture Body (B) is secure, remove the mounting ball and ceiling canopy and Fixture Body (B) and proceed to Step 4.

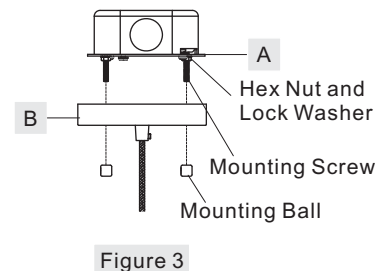

Thank you for purchasing a product.

STEP 4 - Wire Connections

- A. Wrap bare or green ground wire around green ground screw on the crossbar, no less than 2 inches from the end of the wire. Tighten the green ground screw.
- B. Use standard wire connectors (not included) to make all wire connections. Twist connectors until wires are tightly joined together. Wrap each connection with approved electrical tape and carefully stuff all the connected wires into the Outlet Box.
- C. If the electrical wire is going to be cut shorter than provided, strip back the clear wire covering the 3 fixture wires as far as you need to. This will expose each fixture wire individually. Strip each end of 3 fixture wires.

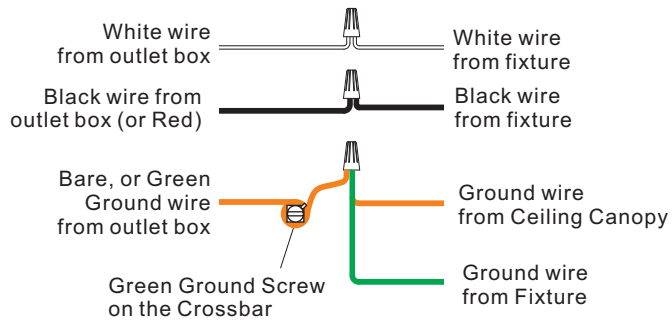

Figure 4

STEP 5 - Install the Fixture

- A. Carefully tuck all wires into the outlet box and position the ceiling canopy and Fixture Body (B) over the outlet box. Align the holes in the ceiling canopy with the mounting screws, then attach the ceiling canopy and Fixture Body (B) using the previously removed mounting balls. Hand tighten until snug.

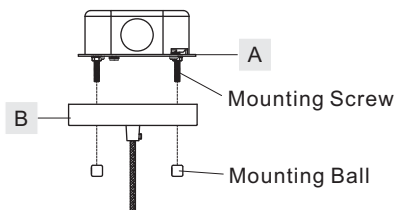

Figure 5

STEP 6 - Install Bulb

- A. Insert the bulb onto socket and screw snugly into place.

Your fixture is now assembled and ready to use. Enjoy!

Figure 6

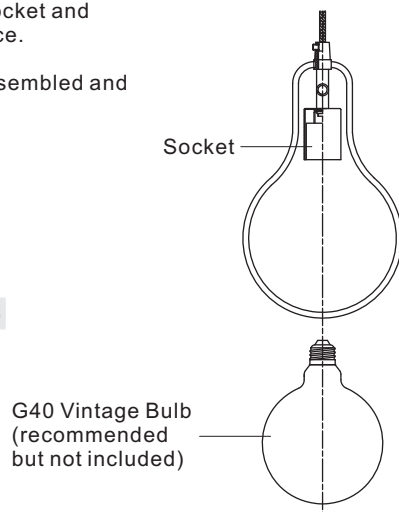

FINISH: EARTH BLACK

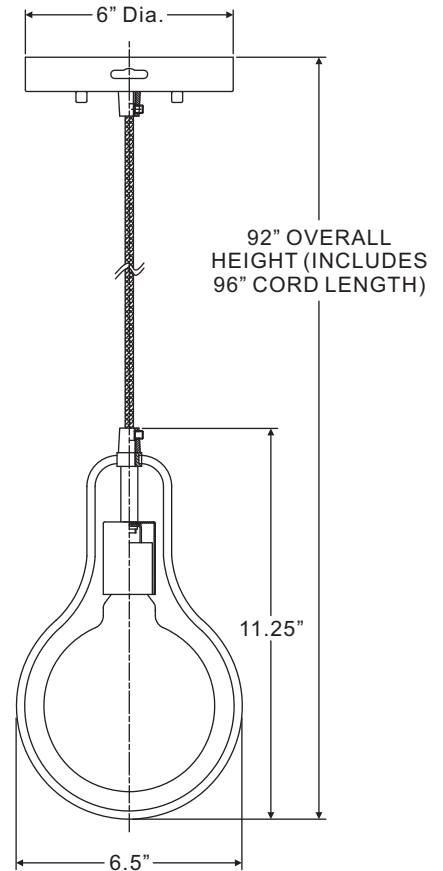
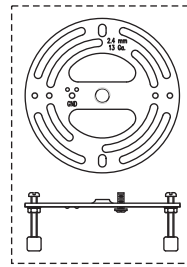

NOTE: ALL DIMENSIONS ARE ROUNDED UP TO THE NEAREST 1/4"

Thank you for purchasing a product.