

## CARE AND MAINTENANCE







Wipe clean with a soft, dry cloth. Test the cleaning method on a hidden area before using them over the entire area.

## NOTICE

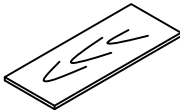
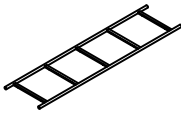
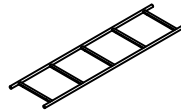
- \* Please make sure that you have all parts indicated before you begin assembly of this item.
- \* This item should be assembled on a soft surface to prevent scratching the finished product during assembly.
- \* This item may require periodic tightening.
- \* Do not tighten bolts until completely assembled.

Product Dimensions: 40"W\*18"Dx72"H

## Part List and Hardware List

PIECE	DESCRIPTION	PICTURE	QUANTITY
A	Shelf		5x
B	Left Side Frame		1x
C	Right Side Frame		1x
D	Connecting bar		2x
H1	Allen Bolt	 1/4"x5/8"	4x
H2	Allen Bolt	 1/4"x1-1/2"	20x
H3	Allen Key	 M4	1x
H4	Anti-Tip Hardware		2x

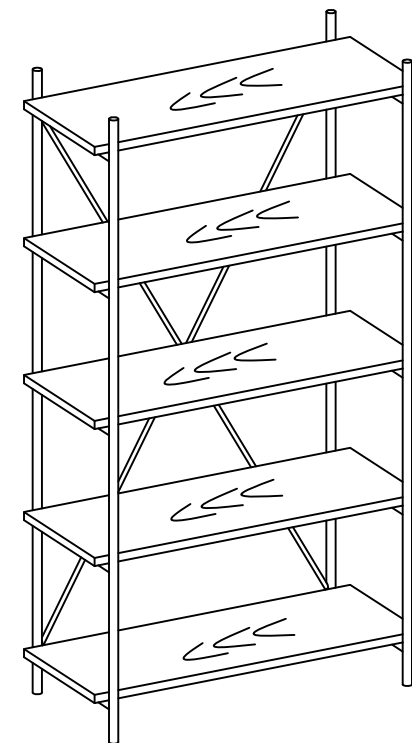

## PREPARATION

Before beginning assembly of product, make sure all parts are present. Compare parts with package contents list and hardware contents list. If any part is missing or damaged, do not attempt to assemble the product.

Estimated Assembly Time: 30 minutes.

Tools Required for Assembly (included): Allen Key

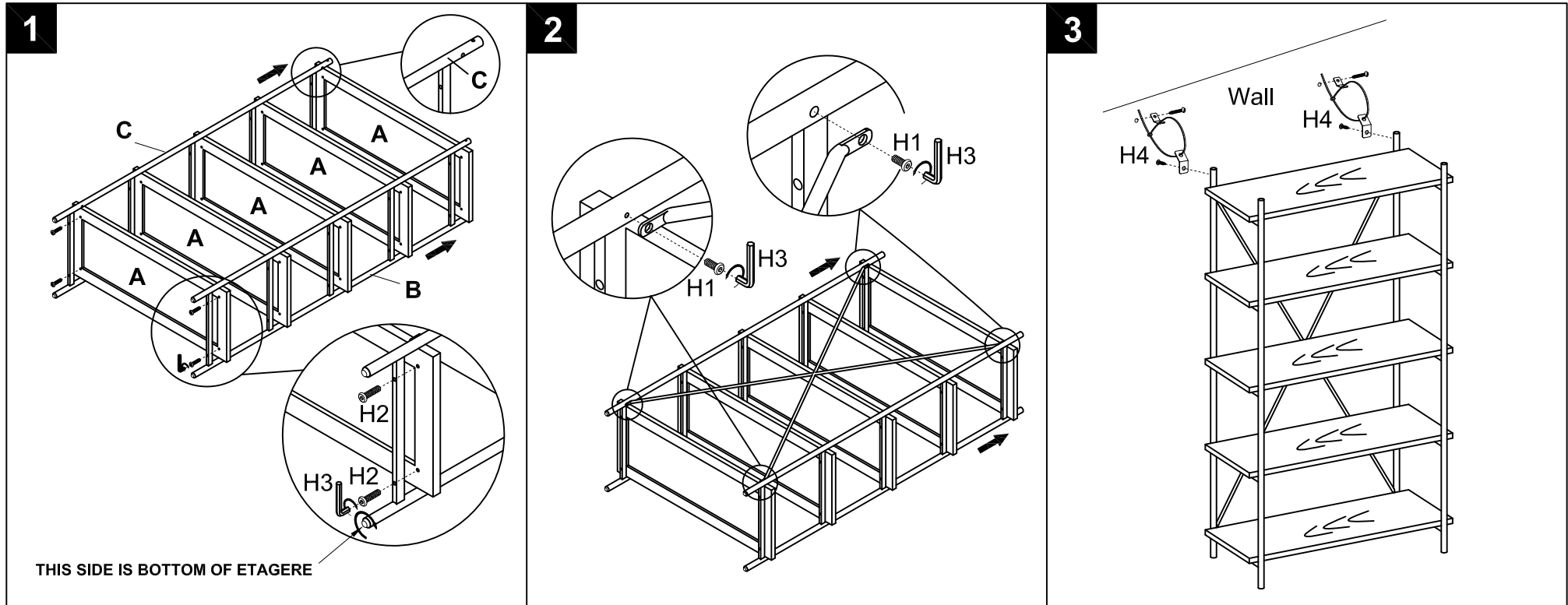

### Step 1

Place 2\*side frames (B/C), the tube with holes is side up, then attach 5\*shelf (A) in the corresponding position and aligning, Use Allen Key (H3) to lock 20\*Allen bolts (H2) with shelves, as picture.

### Step 2

Place 2\*connecting bars (D) to the assembled etagere and aligning, Use Allen Key (H3) to lock 4\*Allen bolts (H1).

### Step 3

Straighten up the assembled etagere, Following the Installation Instructions of anti-tipping to fix the etagere with wall by 2 straps, Assembly is completed.