

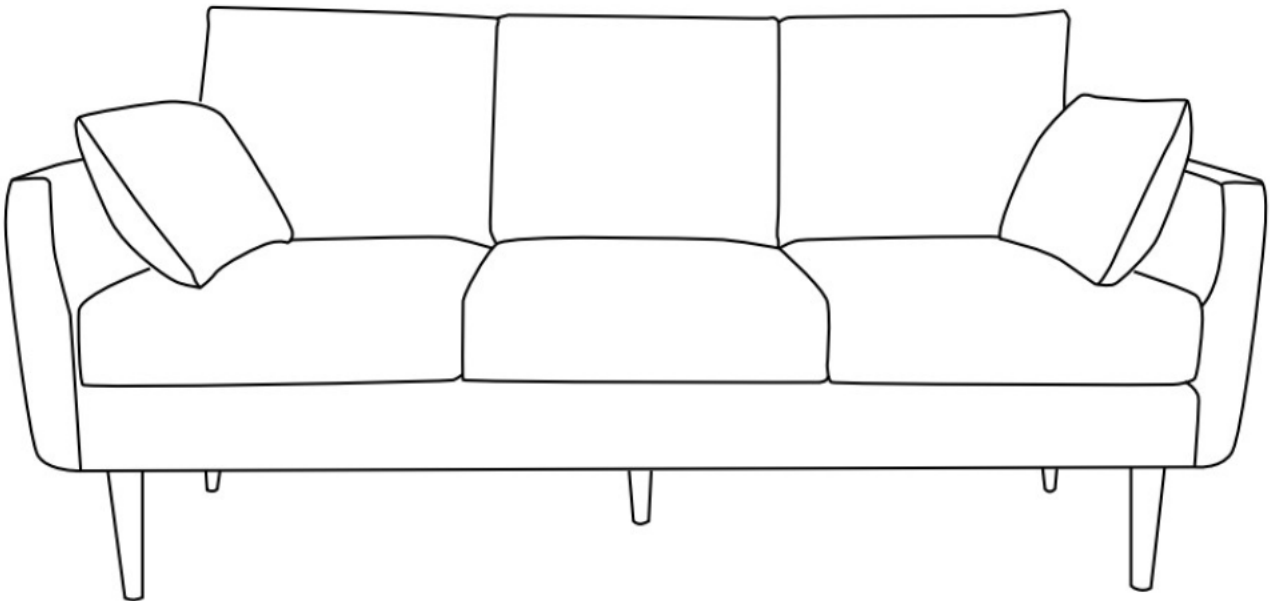





Assembly Instructions

Caution: You must read this before you proceed

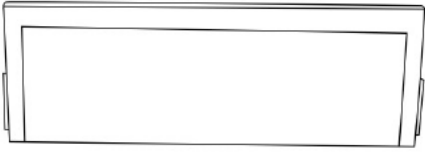
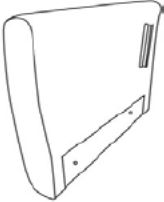
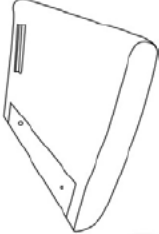

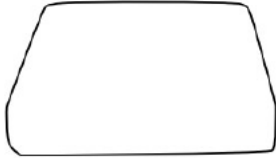
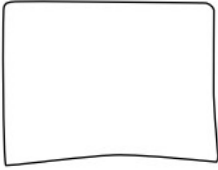

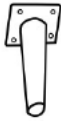

SOFA



Part List

Label	Picture	Description	QTY
A		Backrest	1
B		Left Armrest	1
C		Right Armrest	1
D		Seat	1
E		Seat Cushion	3
F		Back Cushion	3
G		Pillow	2
H		Front Leg	2
I		Back Leg	3

Hardware List

Label	Picture	Description	QTY
①		Screw Arbor	5
②		Flat Washer Ring	5
③		Spring Washer Ring	5
④		Plastic Washer	4
⑤		Nut	5
⑥		Flat Washer Ring(M6)	9
⑦		Spring Washer Ring(M6)	9
⑧		Bolt(M6*25)	9
⑨		Spanner	1
⑩		Allen Wrench	1

Assembly Preparation

Before Beginning Assembly:

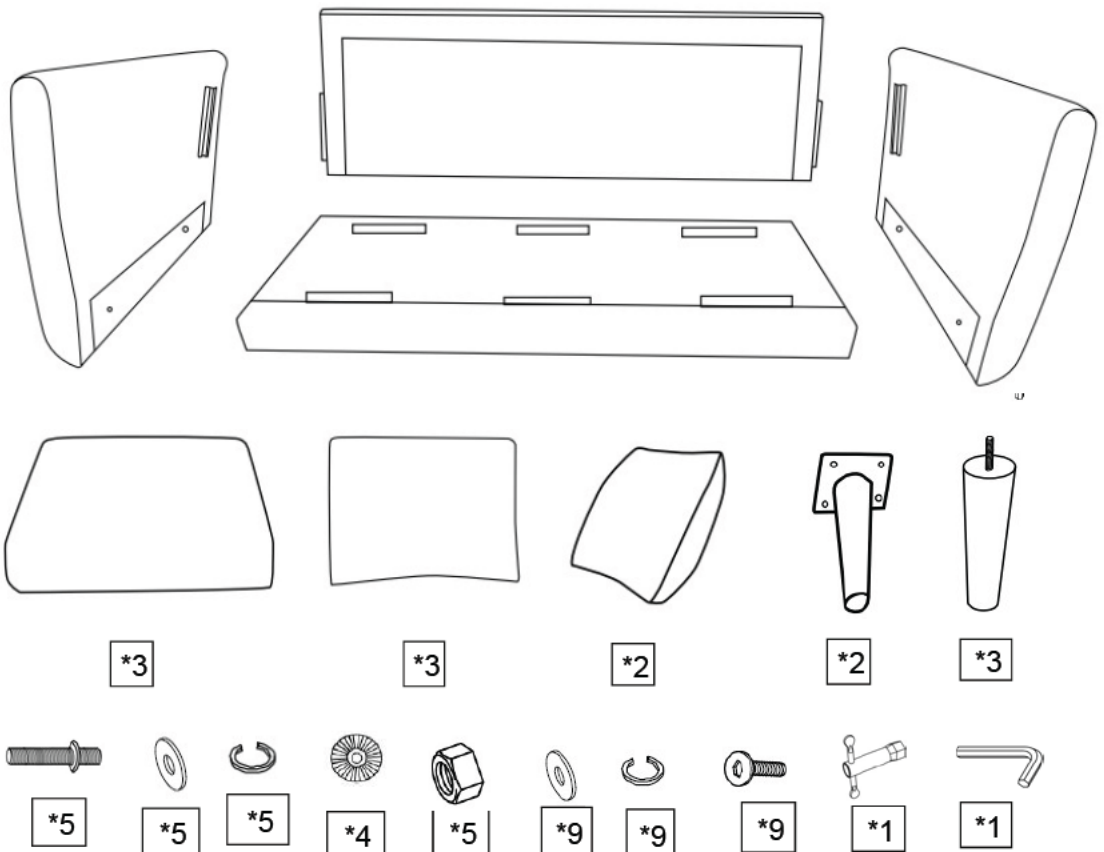



- Read instructions, cover to cover-



- Have 2 adults on hand for assembly-



- Do not assemble on flooring or carpet-



- Assemble on a clean non-marring surface (packing foam)-



- Save all packaging until finished-

Assembly Steps

OVERVIEW

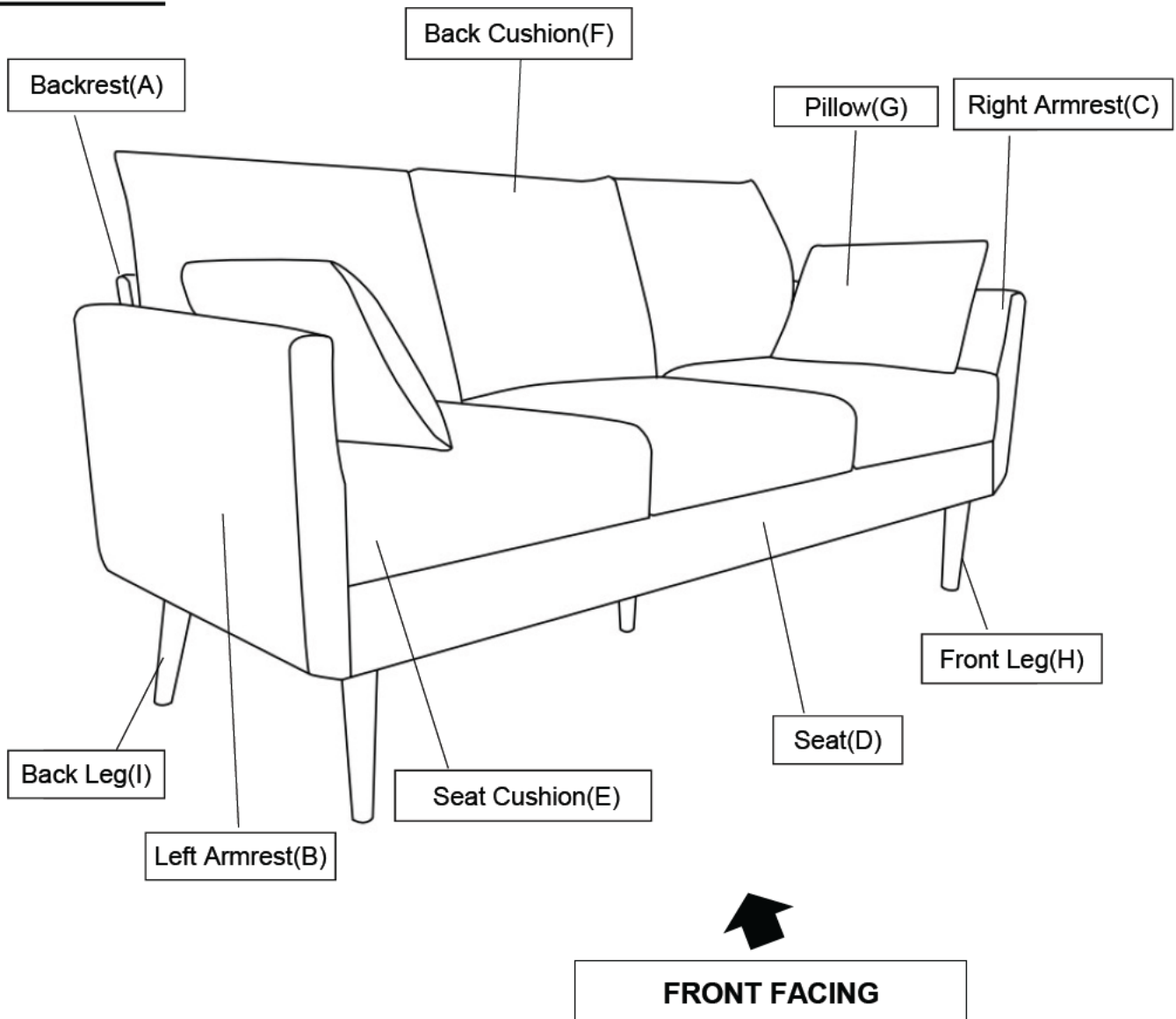

This Sofa has multiple parts and may require up to 60 minutes to assemble. To give you an overview of the Sofa parts, the above picture is to help you put the various parts into perspective. Please read through the instructions below to familiarise yourself with the parts and steps before assembly.

Note: It is recommended that you have an adult partner to assist during the entire assembly process.

Step 1

Left Armrest(B)

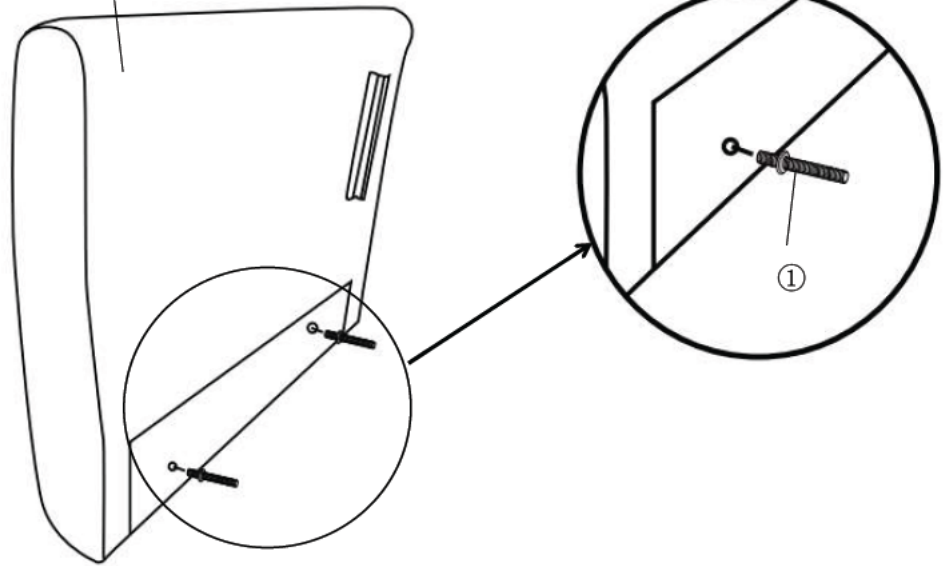

Open the carton and place all the parts on a clean, non-marring surface.
Insert the Screw Arbors(①) into the mounting positions on the Left Armrest(B) by hand until tight.
Repeat the same step on the Right Armrest(C).

Step 2

Left Armrest(B)

Right Armrest(C)

Seat(D)

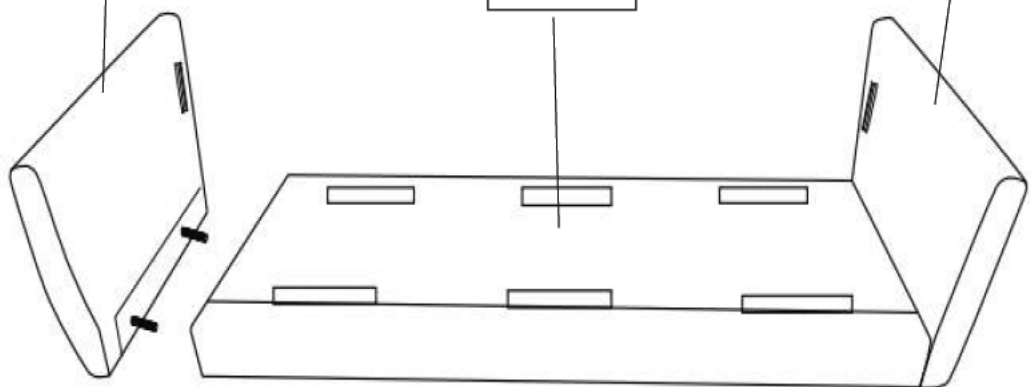

Lay the Seat(D) down on a flat surface.
Insert the Bolts of the Left Armrest(B) into the mounting positions of Seat(D), then attach the Left Armrest(B) to the Seat(D) as shown in the picture.
Repeat the same process with the Right Armrest(C).

Step 3

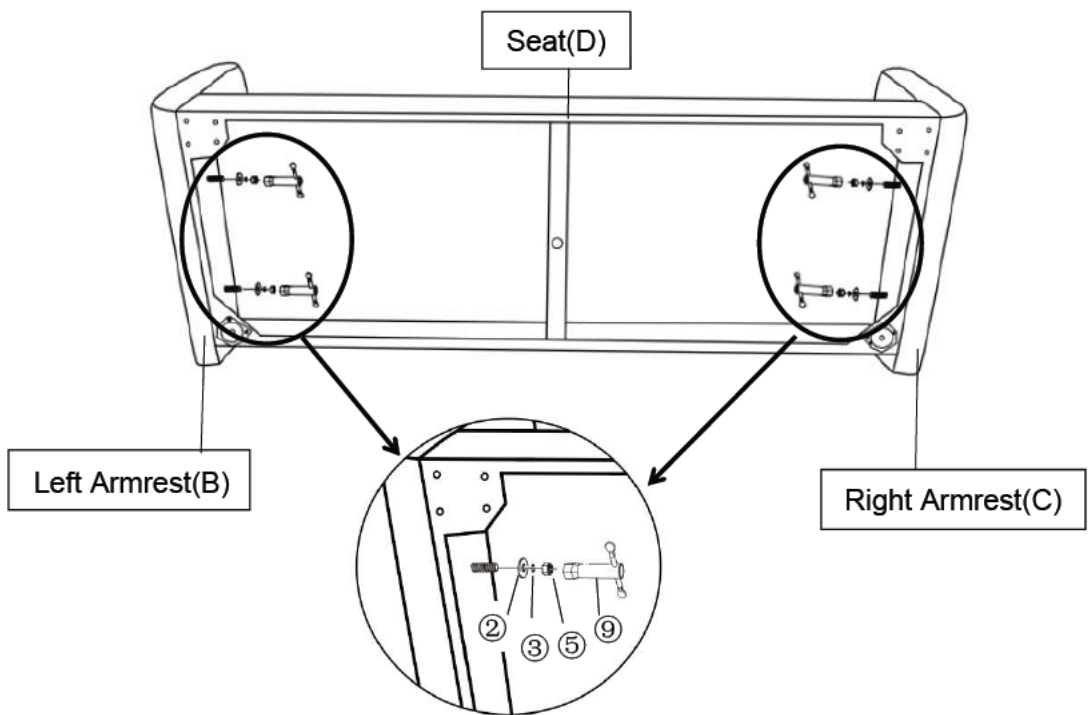

Attach the Left Armrest(B) & Right Armrest(C) to the Seat(D), using Nuts(⑤), Spring Washer Rings(③), Flat Washer Rings(②) with the Spanner(⑨) turning clockwise until tight. Repeat the same process with the remaining Bolts.

Step 4

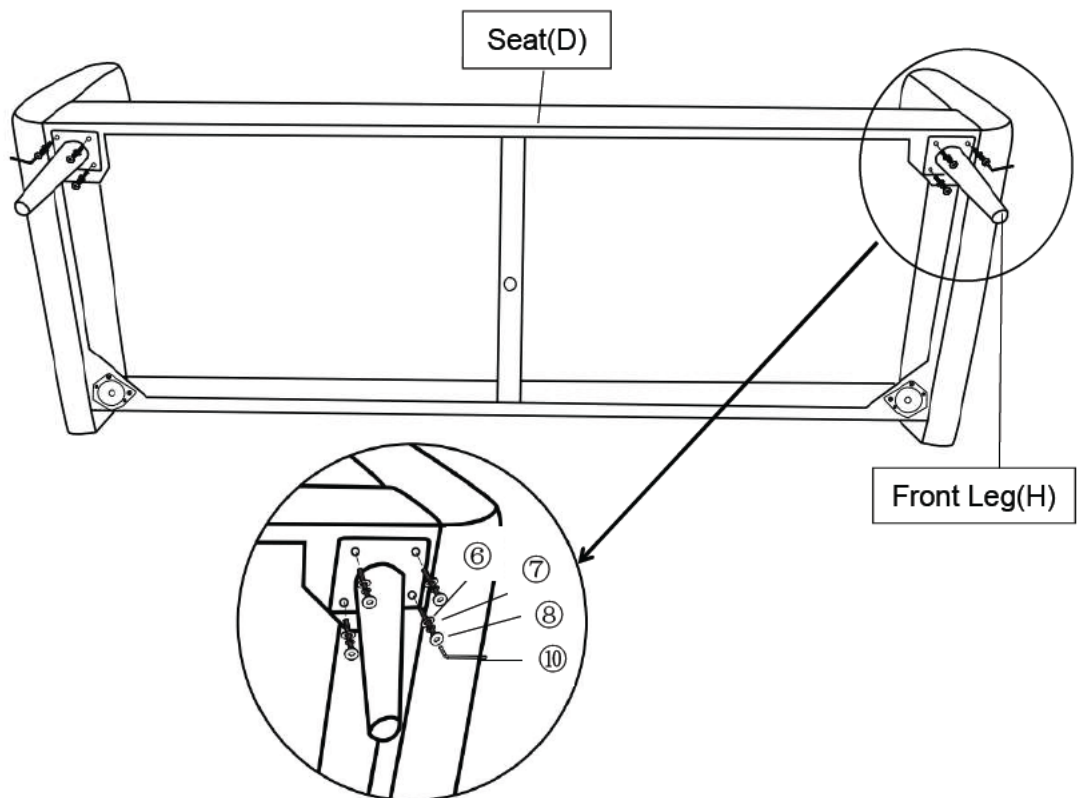

Attach the Front Leg(H) to the Seat(D),using Bolts(ⓑ),Spring Washer Rings(ⓓ),Flat Washer Rings(ⓔ) with the Allen Wrench(ⓐ) turning clockwise until tight.
Repeat the same process with the other Front Leg(H).

Step 5

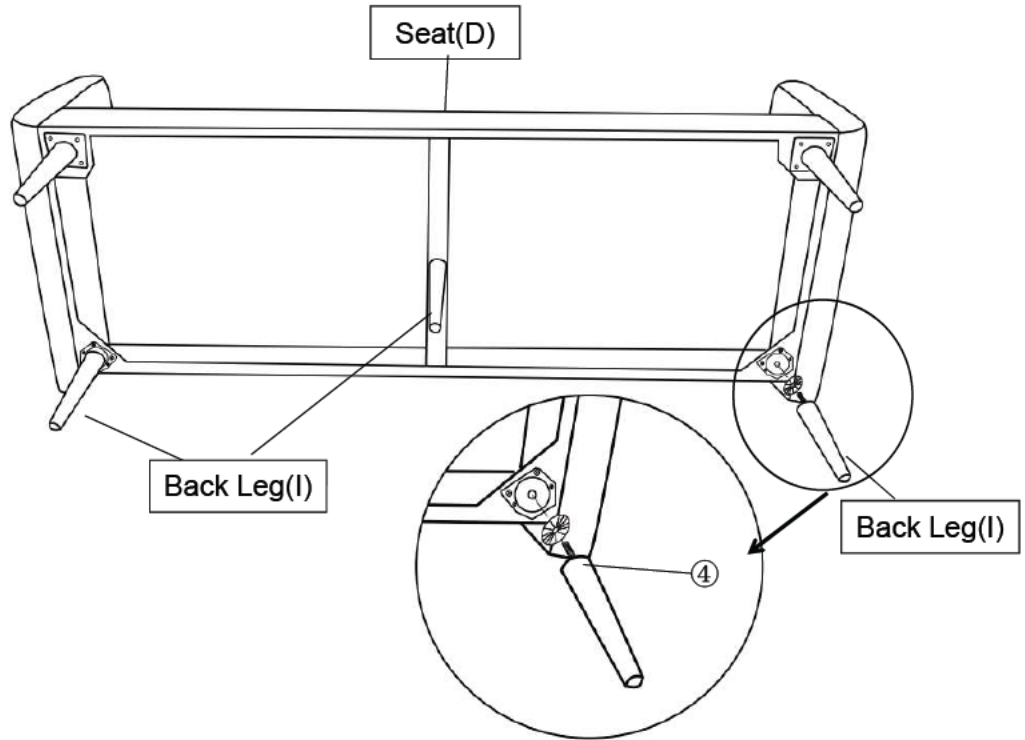

Attach the Back Leg(I) to the Seat(D) by placing one Plastic Washer (④) and tighten by turning the leg clockwise.

Repeat the same process to install the remaining Back Leg(I).

Note: The use of Plastic Washers(④) are OPTIONAL and are especially useful to help alleviate slight wobbleness. Some Legs may need more than one Plastic Washer(④) whilst some Legs may not need any.

Step 6

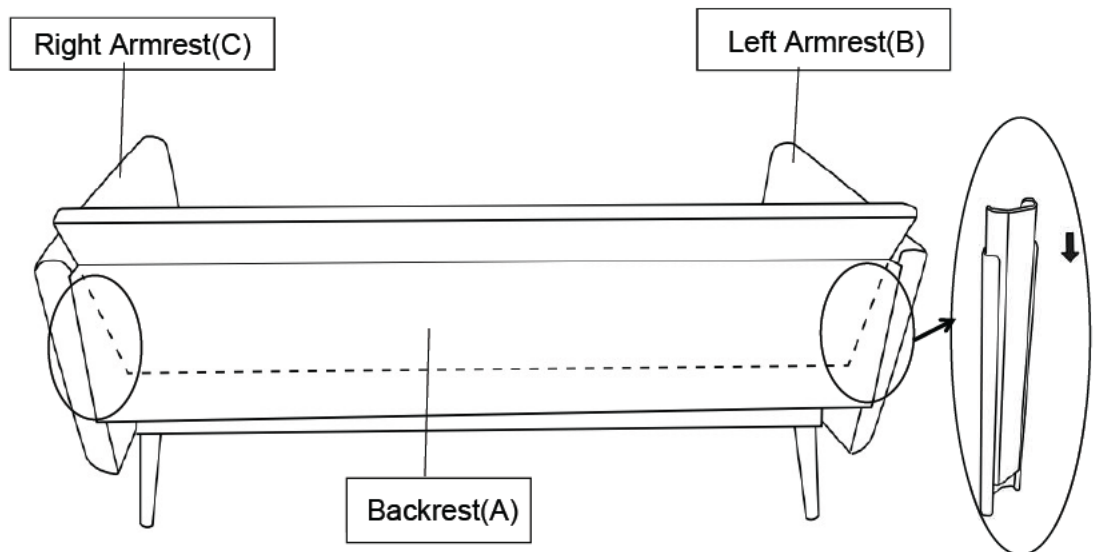

Slide the Tapered Connectors onto the Backrest(A) into the Tapered Connectors on the Left Armrest(B) as shown in the picture.

Repeat the same process with the Right Armrest(C).

Note: Make sure the Tapered Connectors on the Backrest(A) lock into the Tapered Connectors on the Left Armrest(B) and Right Armrest(C).

Keep the Backrest(A) and the back of the Left Armrest(B), and the Right Armrest(C) flat.

Assistance from an adult partner is necessary for this assembly process.

During this assembly process - do exercise caution. You may need to use your hand to press down and or pave away the padded surface to facilitate the 'slip and slide' assembly.

Caution: Ensure that your fingers do not get caught or pinched in the assembly process.

Step 7

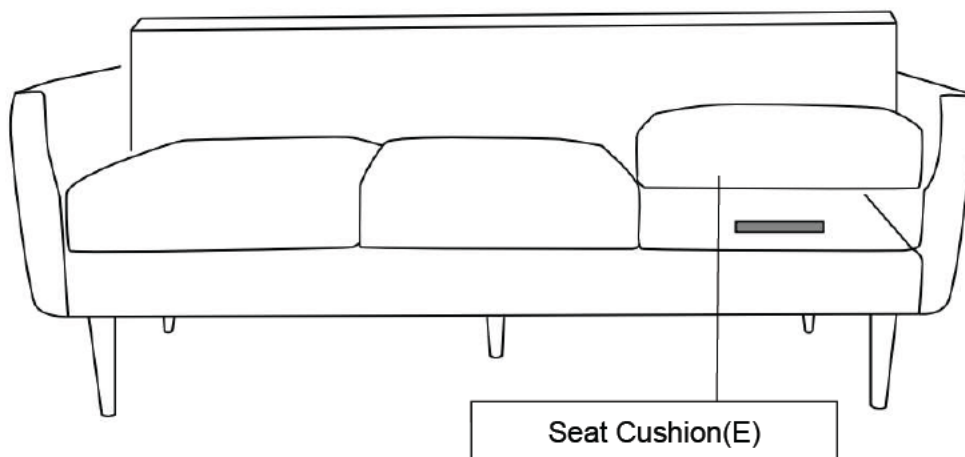

Put the Seat Cushions(E) on the sofa.

Step 8

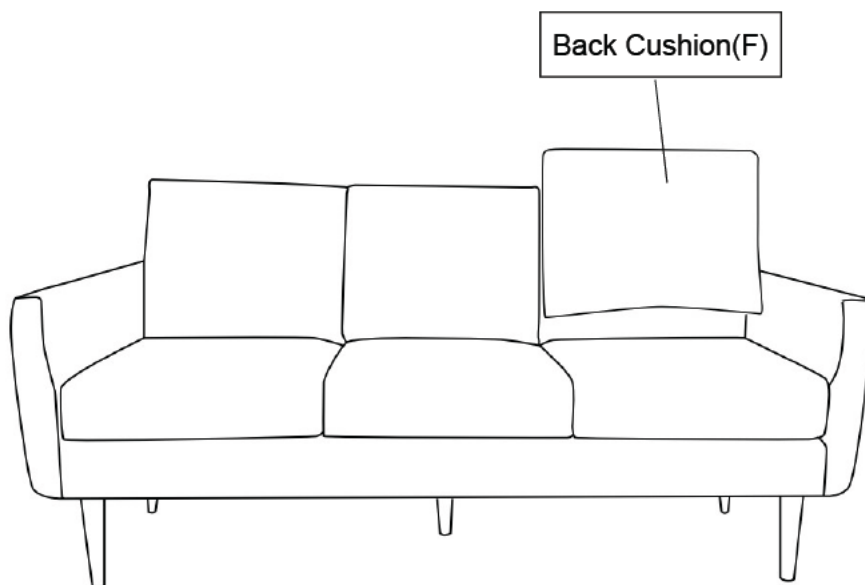

Put the Back Cushions(F) on the sofa.

Step 9

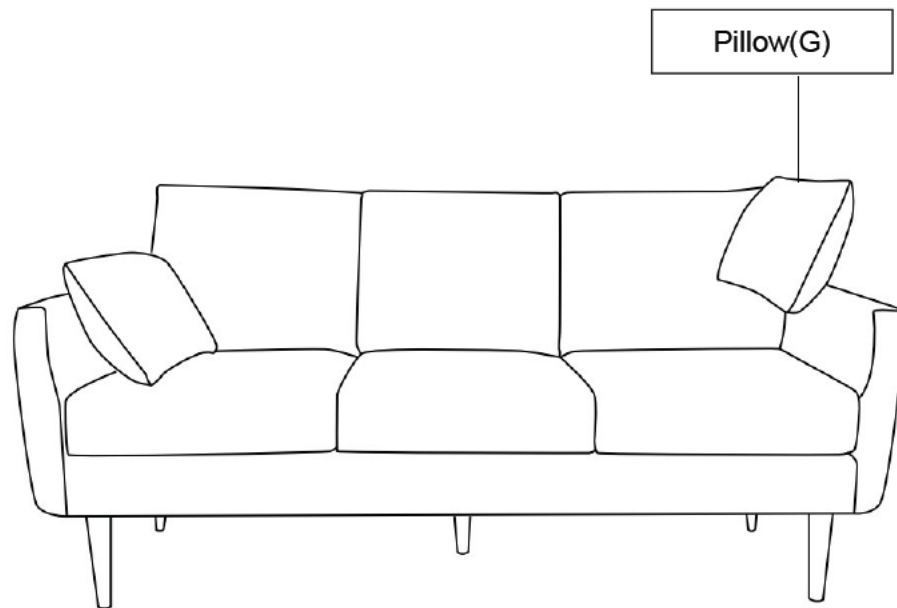

Put the Pillows(G) on the sofa.

Step 10

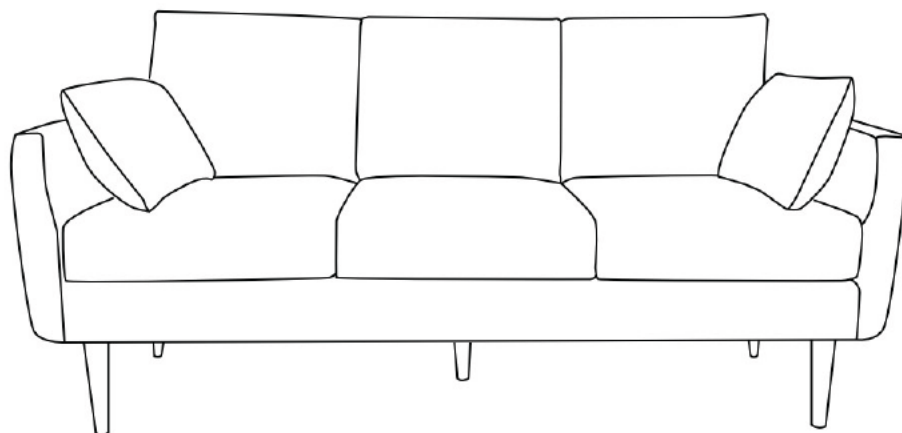

Your Sofa is ready for use.
This Sofa can only be used on a flat, level surface.

Care & Maintenance



- Furniture may scratch floors. We recommend using furniture pads to protect your floors.



- Do not put hot items directly on furniture surface.



- Do not clean furniture with harsh cleansers or polish.



- Do not place furniture under direct sunlight.



- Do not place furniture near heating or cooling vents.

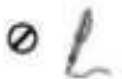

- Do not write on furniture without a padded barrier to protect the surface.



- Do not place furniture outside . For indoor use only.



- Not for commercial use. For residential use only.



- Stains may be removed with mild soap solution and damp cloth.



- Children should not climb or jump on the furniture.



- Dust and pick-up spills using a clean, non-colored, lint-free cloth.