







ASSEMBLY TIPS :

1. Remove hardware from plastic bag and sort by size.
2. Please check to see that all hardware and part are present prior to start of assembly.
3. Please follow attached instruction in the same sequence as numbered to assure fast & easy assembly.



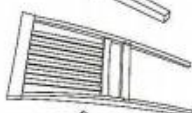



**Warning !**

1. Don't attempt to repair or modify parts that are broken or defective. Please contact the store immediately.
2. This product is for home use only and not intended for commercial establishment.

PARTS IDENTIFICATION:

A		TABLE TOP	1PC
B		TABLE LEG	4PCS
C		CHAIR BACK	4PCS
D		FRONT LEG FRAME	4PCS
E		SIDE RAIL	8PCS
F		WOOD SEAT	4PCS

HARDWARE IDENTIFICATION:

1		ALLEN WRENCH	1PC
2		LONG BOLT	8PCS
3		LARGE LOCK WASHER	8PCS
4		FLAT WASHER	8PCS
5		SHORT BOLT	24PCS
6		SMALL LOCK WASHER	24PCS
7		PAN HEAD SCREW	12PCS

STEP 1

Place table top upside down on soft surface, then align and fasten all legs to table top using long bolt, large lock washer and flat washer and tighten with Allen wrench.

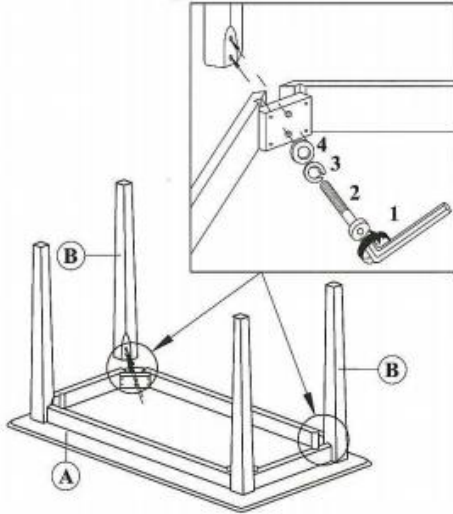
**STEP 2**

Flip table over using two people to lift and flip this table.

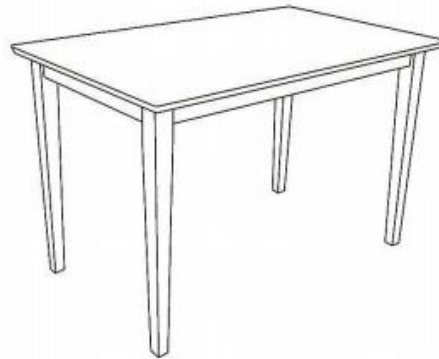
**STEP 3**

Align and fasten side rail to front leg frame using short bolt and small lock washer and tighten with Allen wrench.

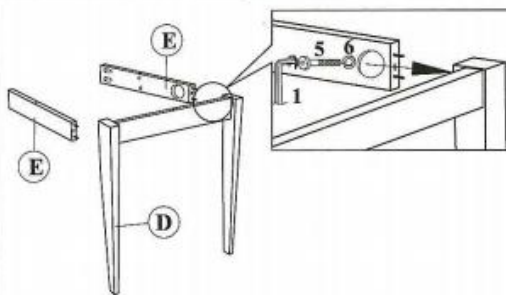
**STEP 4**

Align and fasten side rails to chair back using short bolt and small lock washer and tighten with Allen wrench.

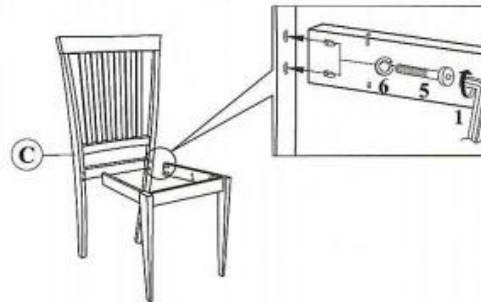
**STEP 5**

Align and fasten wood seat to side and front rails using screws and tighten with screw driver (Not provided).

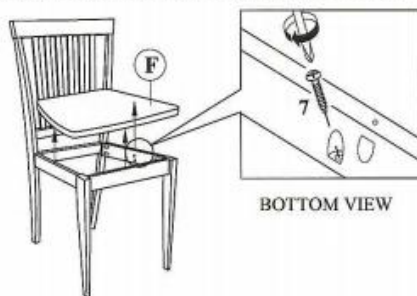
**STEP 6**

Complete.

