

SINGLE BED
ASSEMBLY INSTRUCTIONS

ITEM: 232Q

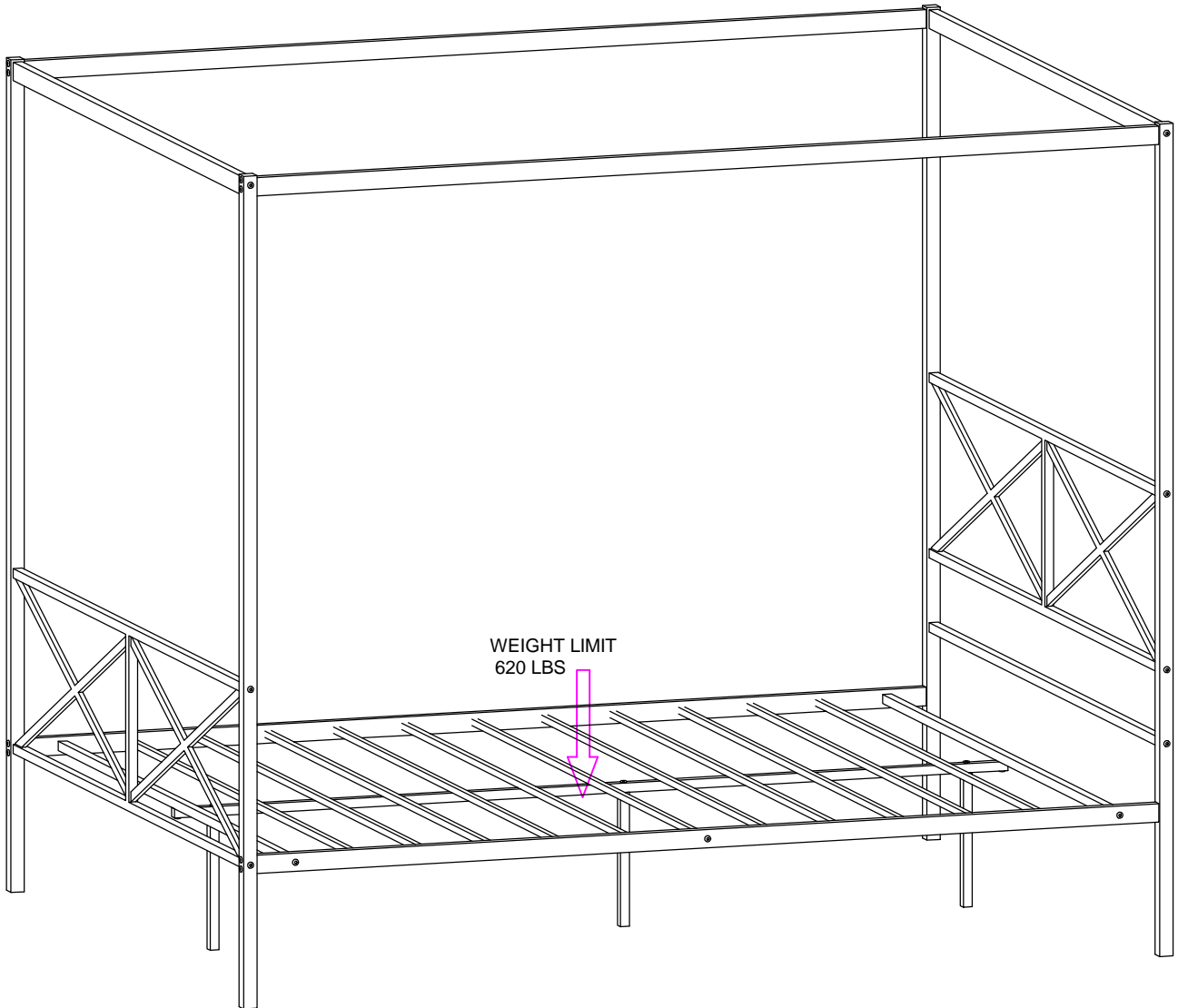

PLEASE DO NOT RETURN PRODUCT TO THE STORE
If you have any problem or concerns, please feel
free to contact our customer service department.
We will reply you as soon as possible.



E-mail : wmsr@comptree.net
Tell: 626-912-8886 Ext. 100

SINGLE BED
ASSEMBLY INSTRUCTIONS

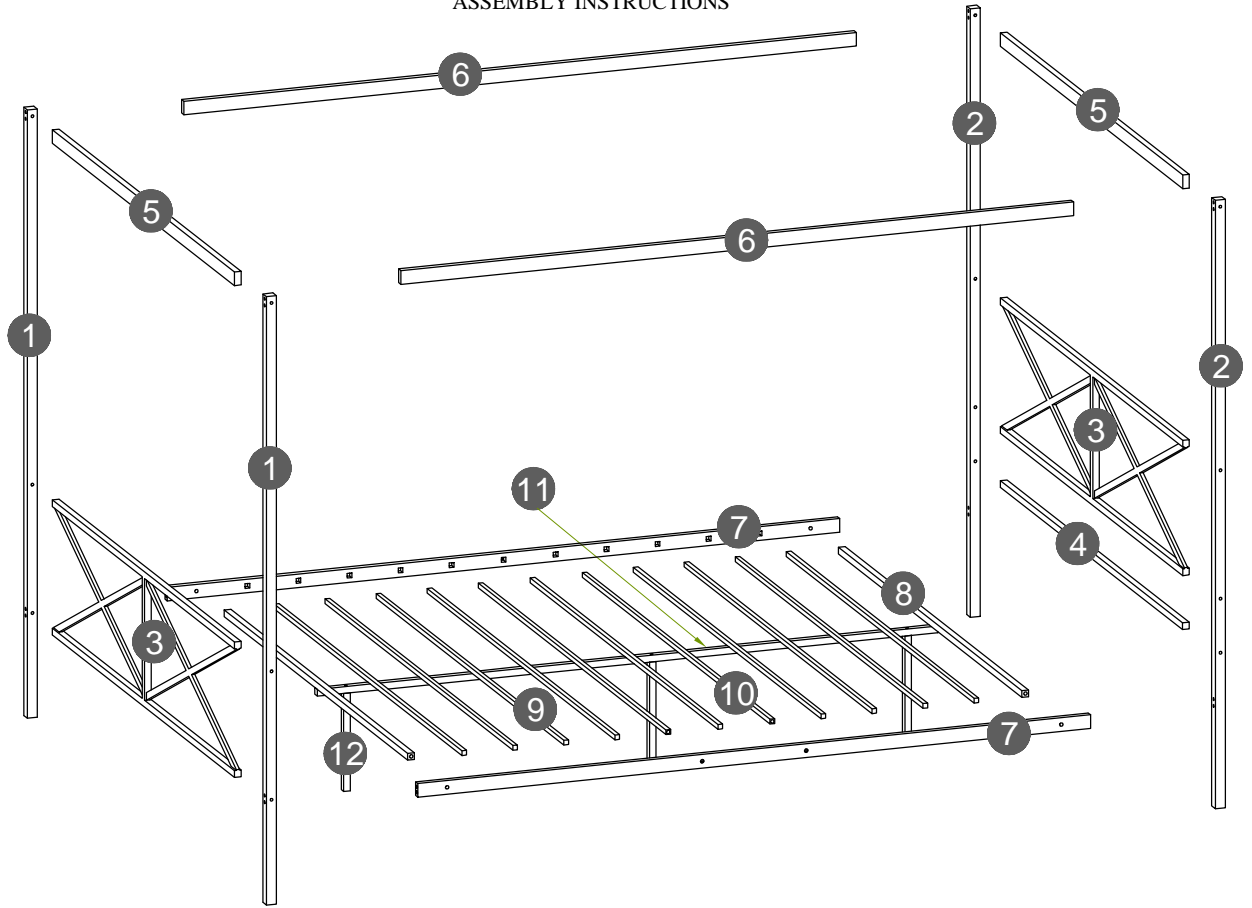



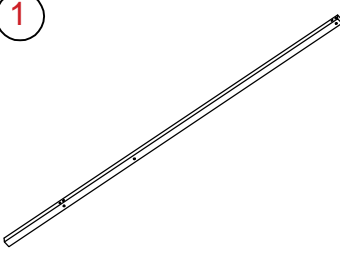
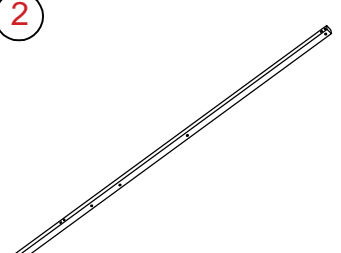
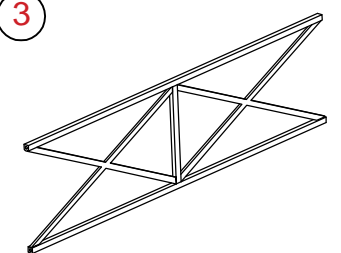
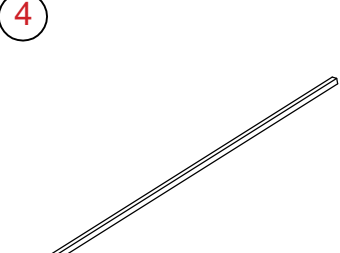
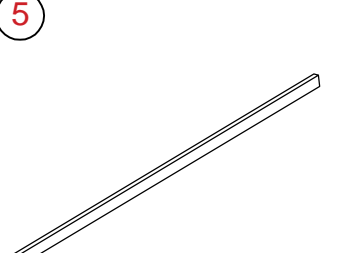
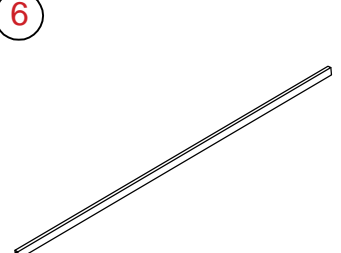
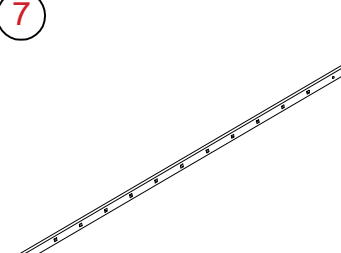
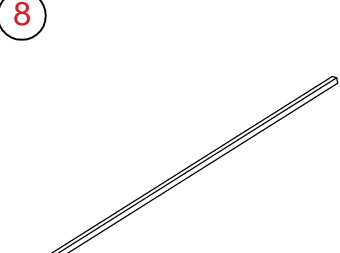
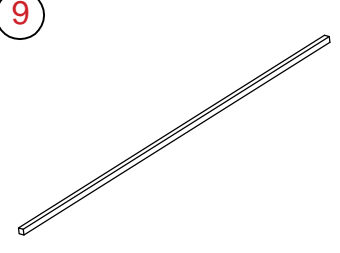
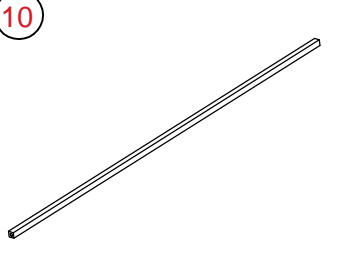
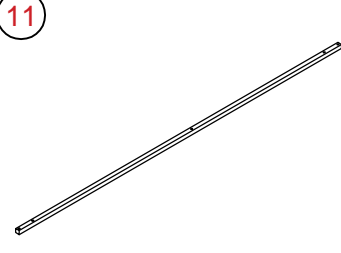
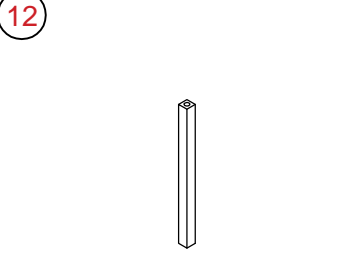

PART LIST



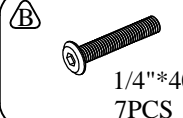

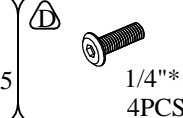

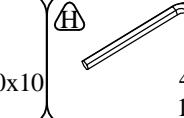



 2PCS	 2PCS	 2PCS	 1PC
 2PCS	 2PCS	 2PCS	 2PCS
 9PCS	 2PCS	 1PC	 3PCS

SINGLE BED
ASSEMBLY INSTRUCTIONS

HARDWARE LIST

 1/4"*50 30PCS	 1/4"*40 7PCS	 1/4"*35 2PCS	 1/4"*15 4PCS	 30x30x10 8PCS	 20x20x10 3PCS	 4x60 1PC
---	--	--	--	--	---	--

IMPORTANT SAFETY NOTICE: READ CAREFULLY BEFORE BEGINNING ASSEMBLY!

-  Hardware packs and small components should be away from the children, avoid eating and being injured
-  Please, follow with the assembly steps in order
-  Please, do not tighten any screw before each assembling unit is well placed in appropriate position
-  Please, make sure all components are fixed firmly locked without any potential safety hazard After assembly and before using
-  Please, use this product correctly, according to its purpose to avoid danger happened
-  Please, do not stand on any component of this product, except the ladder of this product after fixing locked safely
-  Such as the wall fastening devices are essential parts of this product. Please fix firmly locked without any potential safety hazard before using
-  Please check all contents of this product inside of carton (s) carefully, small parts may have been lost during shipment, if any! contact further with the retailer from which you purchased this product to obtain, do not use any substitute part
-  This assembly instructions booklet contains important safety information, please read and keep for further reference
-  This products is designed referring to overall loading of each set final product, Please avoid to load on single point of final product making damaged
product name : Bushwick Platform Bed : 620 LBS (maximum)

STEP 1

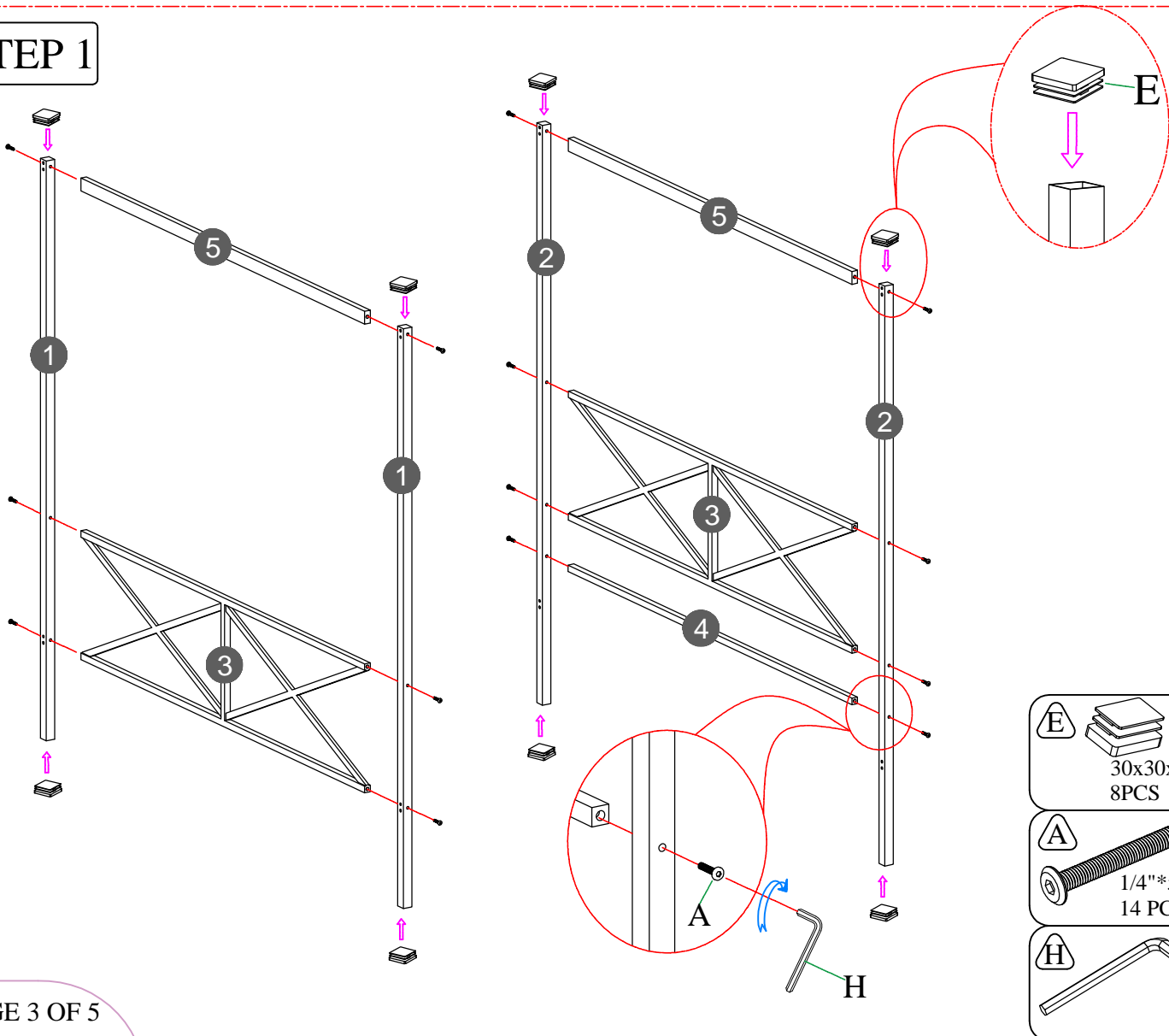

SINGLE BED
ASSEMBLY INSTRUCTIONS

STEP 2

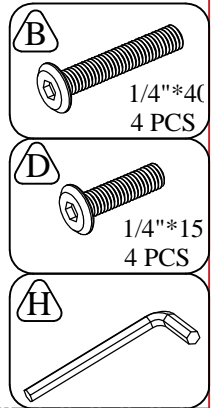
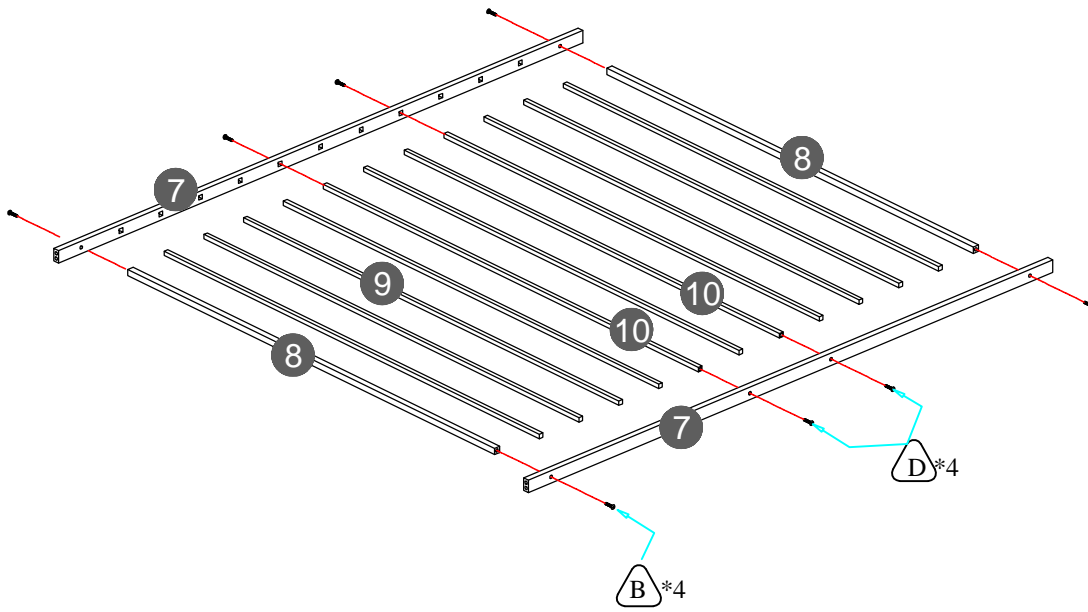

STEP 3

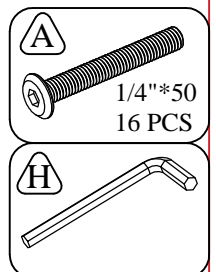
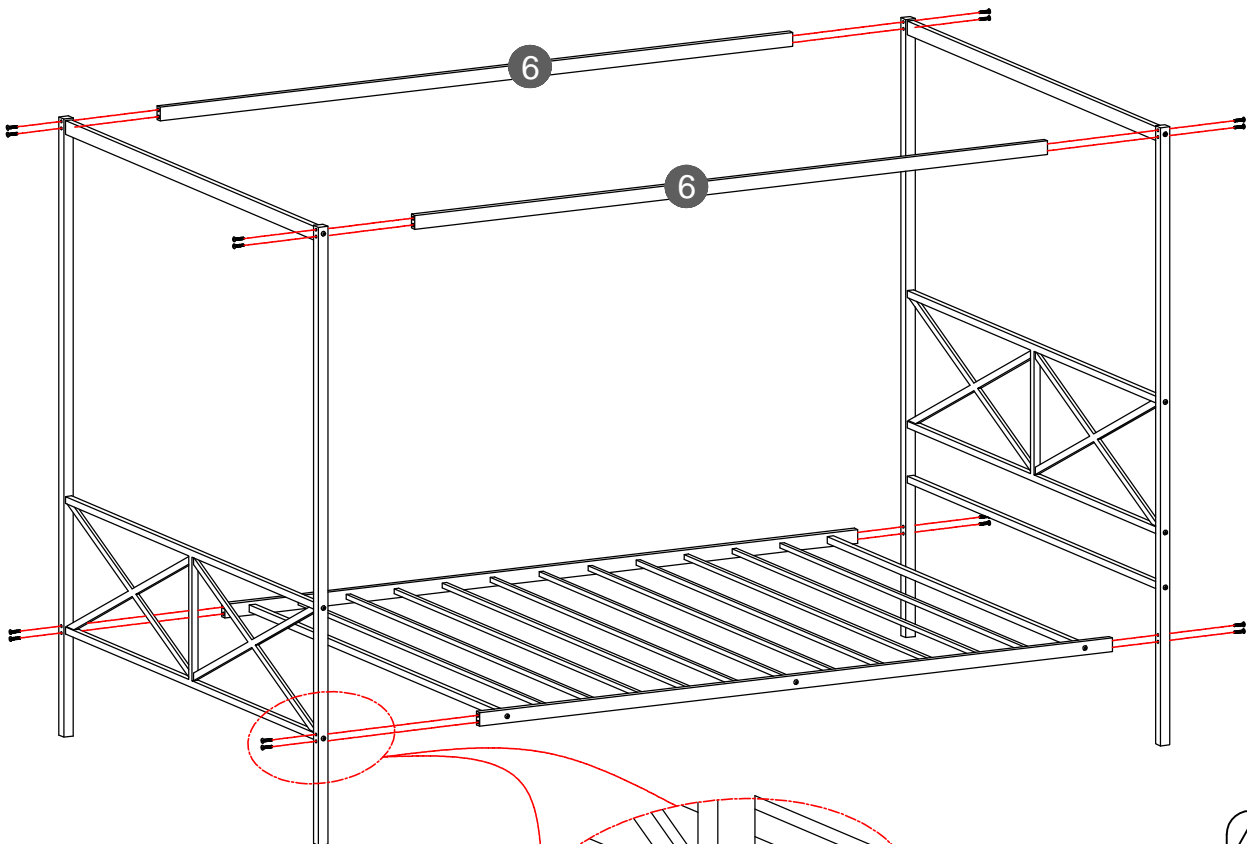

SINGLE BED
ASSEMBLY INSTRUCTIONS

STEP 4

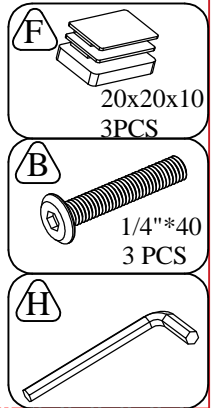
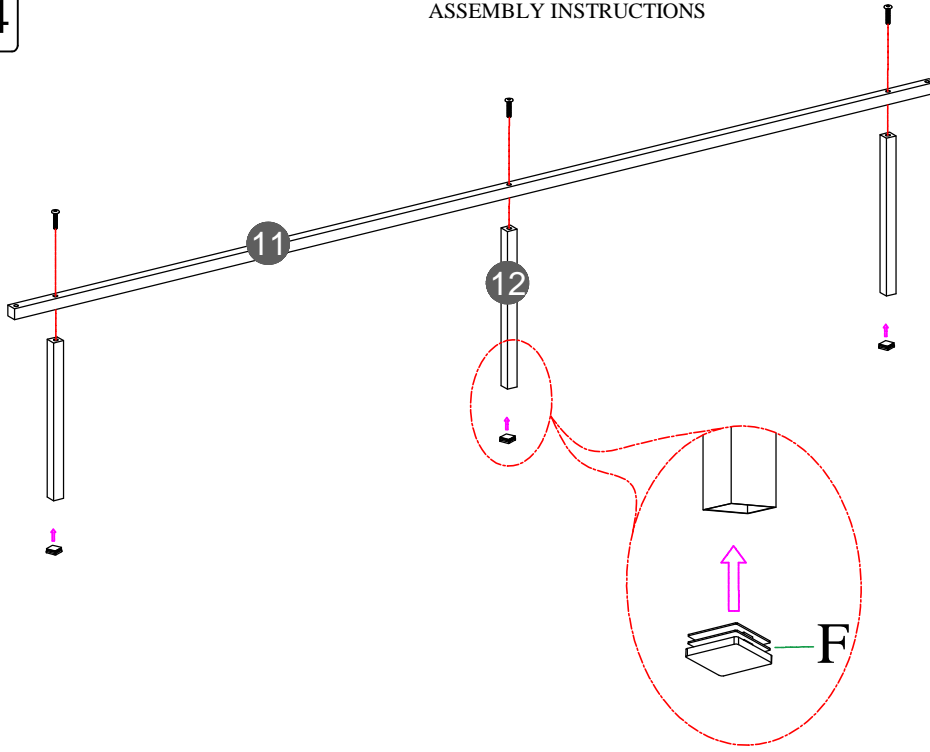

STEP 5

