







Assembly Instructions

Your recliner comes packaged in TWO boxes. Carefully remove all components from the packaging and set aside for assembly.

CAUTION:
DO NOT use any sharp objects to open plastic wrapped components as damage to product or components may result.

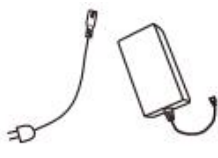
Package Contents

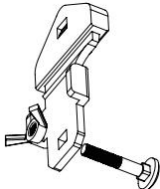
				
A 1* Chair Seat	B 1*Backrest	C 1*Left Armrest	D 1*Right Armrest	E 2*Ears
				
F 1* Power Source	G 1* Power Cord	H 1* Massage Remote	I 2*Supporting Feet	

Step 1

Find a small bag in the accessories box. Take out **Supporting Feet(I)** from the small bag.

Assemble the two Supporting Feet as shown on the bottom of mechanism to avoid toppling and falling.

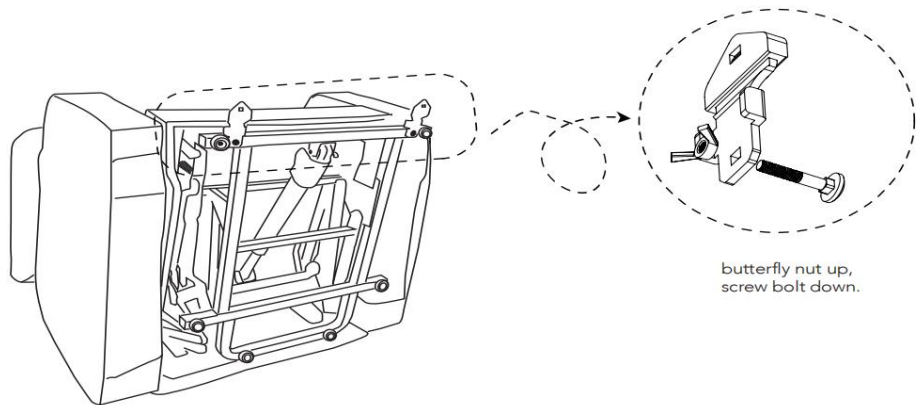

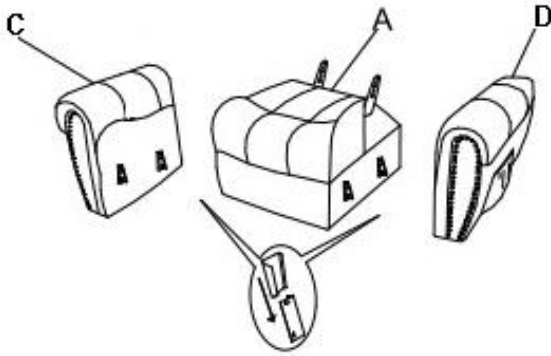

Step 2

Connect the Armrests (C&D) to the chair seat(A) by aligning the metal grooves and sliding down to the bottom.

Step 3

Connect the seat back(B) to the chair seat(A) by aligning the metal grooves and sliding down to the bottom.

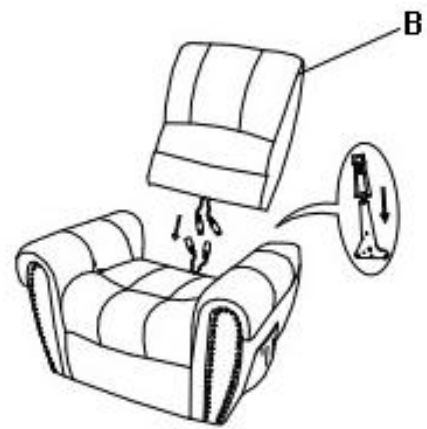

Step 4

Install both of chair ears (E) by aligning the metal grooves and sliding down to the bottom.

Instructions of Connecting Power Cords

No.1 and No.2 wires connect the backrest to the chair seat.

No.3 wire connects the backrest to the power cord(G).

No.4 wire connects up the backrest and massage remote(H).

No.5 wire connects the motor with the wire from right armrest, which has a control panel.

No.6 wire connects the motor to the power source(F).

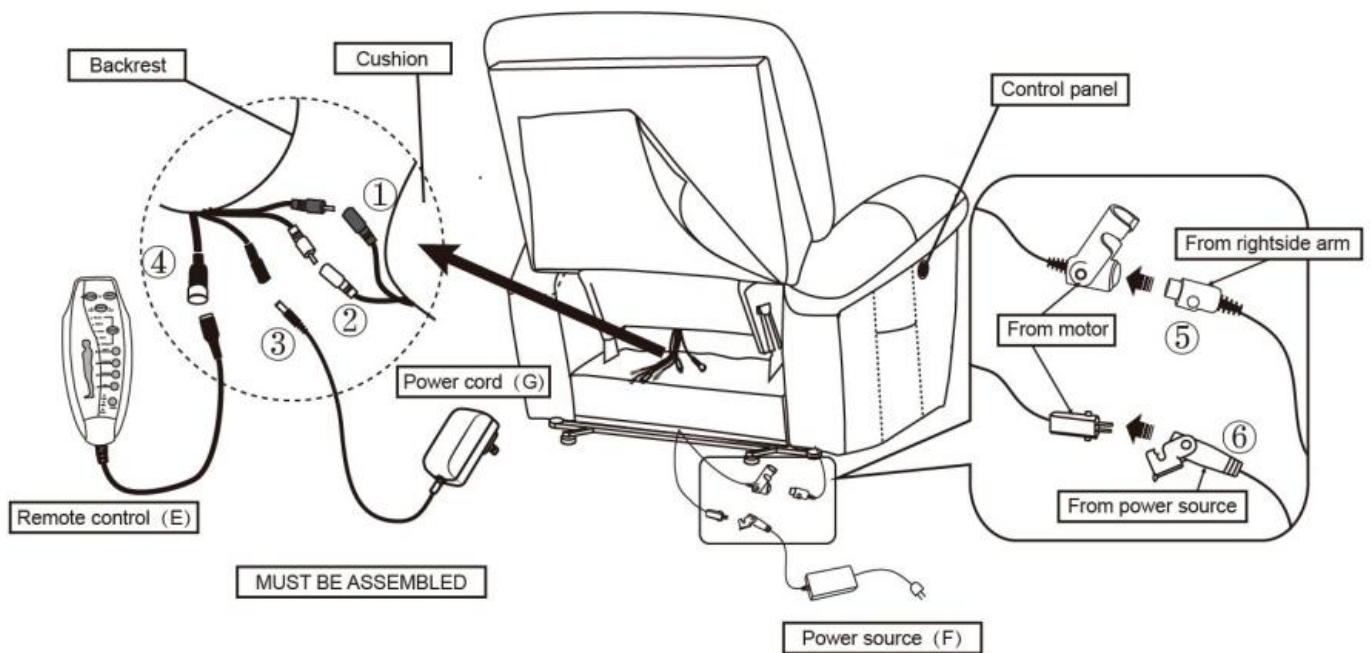

Note:

1. The connection plugs have different colors, black to black, white to white, red to red.
2. Plug both the **Power Cord(G)** and **Power Source(F)** into outlet to get the recliner working.

Remote Operation Instruction

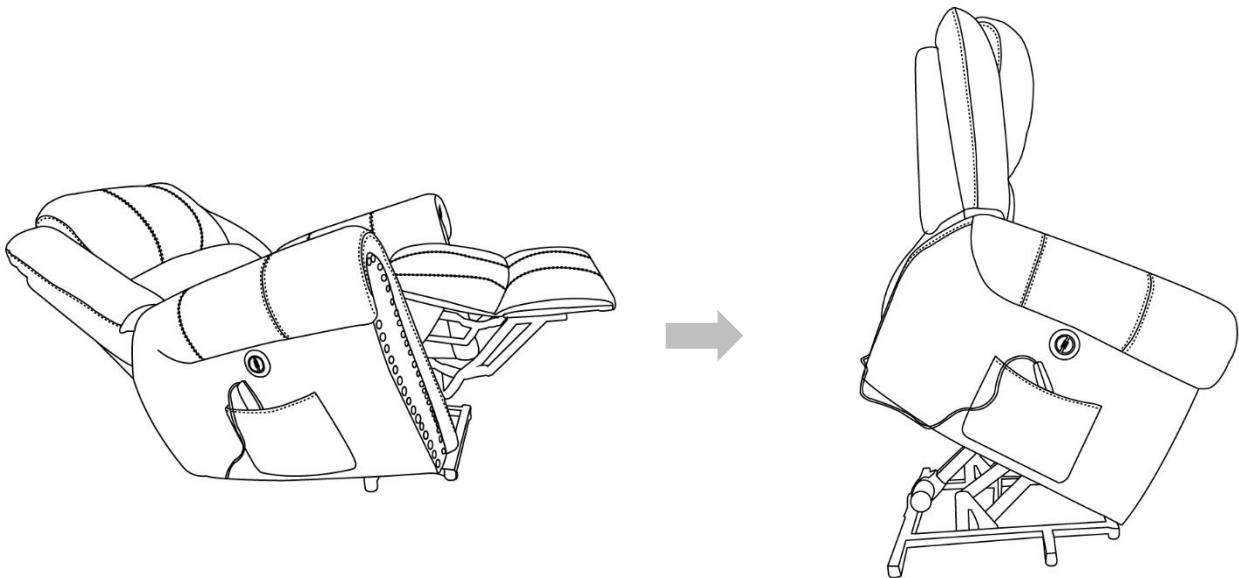
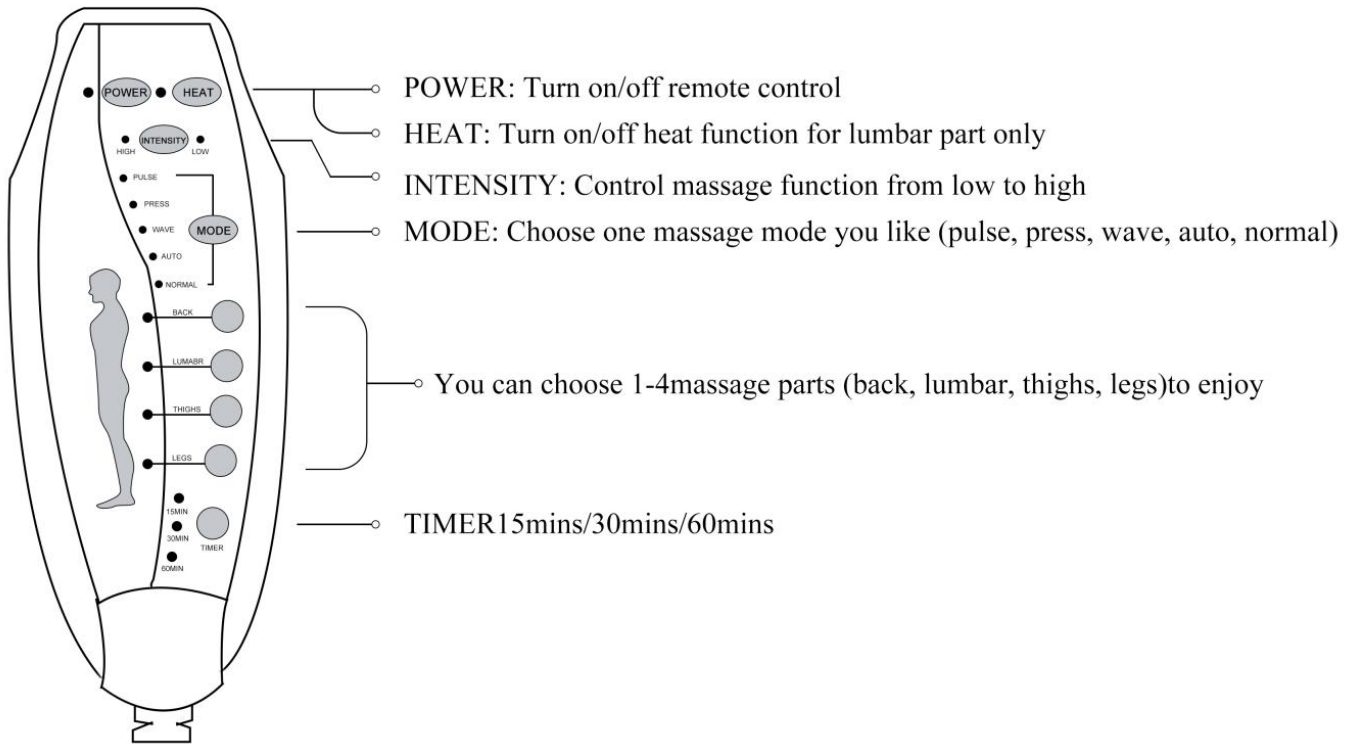

*Different positions by pressing **the button** to switch, the lift recliner chair can meet your various needs.*

Warnings

1. Please check if the components of the chair are all included and can be used normally as the 6th tip.
2. Assemble all components according to the instruction correctly before you connect the chair with the power.
3. Please DO NOT sit on the armrests or footrest to eliminate the risk of tipping over.
4. Please use carefully to avoid sliding from the chair when lifting.
5. If the sofa is damaged or doesn't match the website product, please send clear pictures of the product and label of the carton to our service team, and we'll help you to solve the problem.
6. If the lift recliner doesn't work, you can try the following measures for self-checking firstly:
 - ① Check if all the cables are connected;
 - ② Check if the light of transformer is on;
 - ③ If the motor has a weak buzz on condition that two steps above are normal.If the chair still doesn't work, please feed the information back to the customer service in time. We will help solve the problem for you as soon as possible.
7. If you have any questions with the product, (we will reply to you within 24 hours)

