

# ASSEMBLY INSTRUCTION

## METAL FULL BED

- A** Headboard Leg      **B** Headboard      **C** Footboard      **D** Front Rail Section

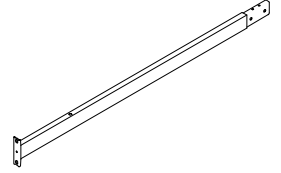
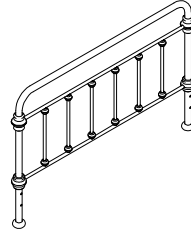
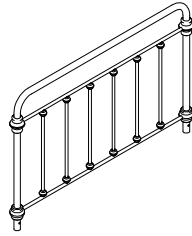
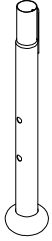

2PCS

1PC

1PC

2PCS

- E** Rear Rail Section      **F** Center Support Bar      **G** Front / Rear Support Bar      **H** Support Leg

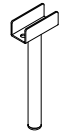
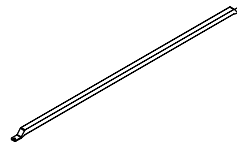
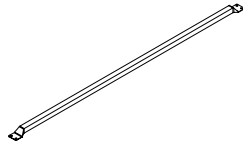
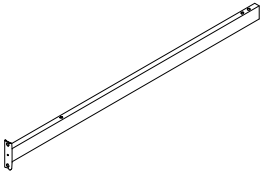

2PCS

1PC

2PCS

4PCS

- I** Bolt 5/16"\*19mm      **J** Bolt 1/4"\*17.5mm      **K** L-Allen Key 4mm

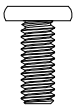

8PCS

22PCS

1PC

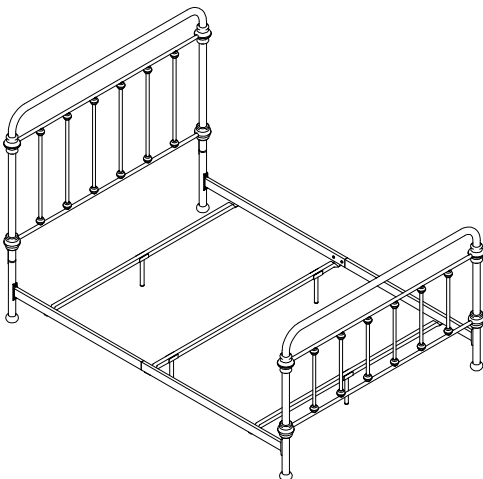

This page lists all the contents included in the box. Please take the time to identify the hardware as well as the individual components to this product. As you unpack and prepare for assembly, place the contents on a carpeted or padded area to protect them from damage.

**1**

Insert the Headboard Leg (A) into the Headboard (B), insert the Bolt (J), turn the L-Allen Key (K) to tighten them.

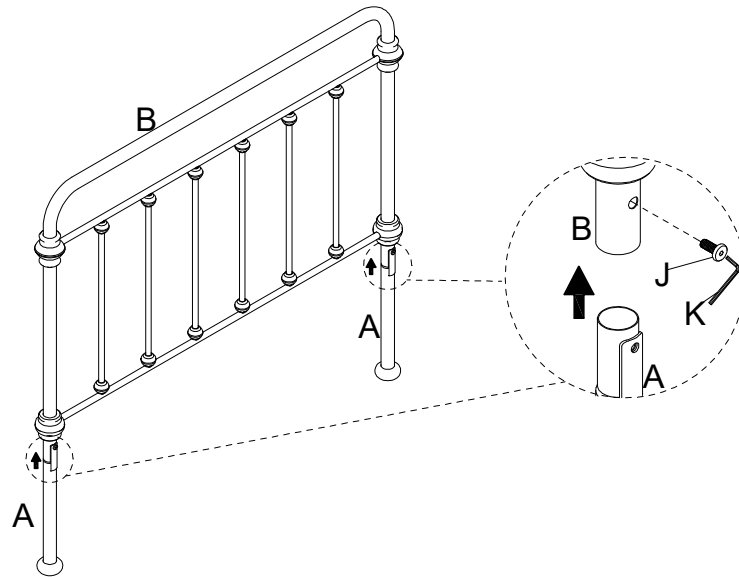
**2**

Insert the Front Rail Section (D) to the Rear Rail Section (E), and then insert the Bolt (J), turn the L-Allen Key (K) to tighten them.

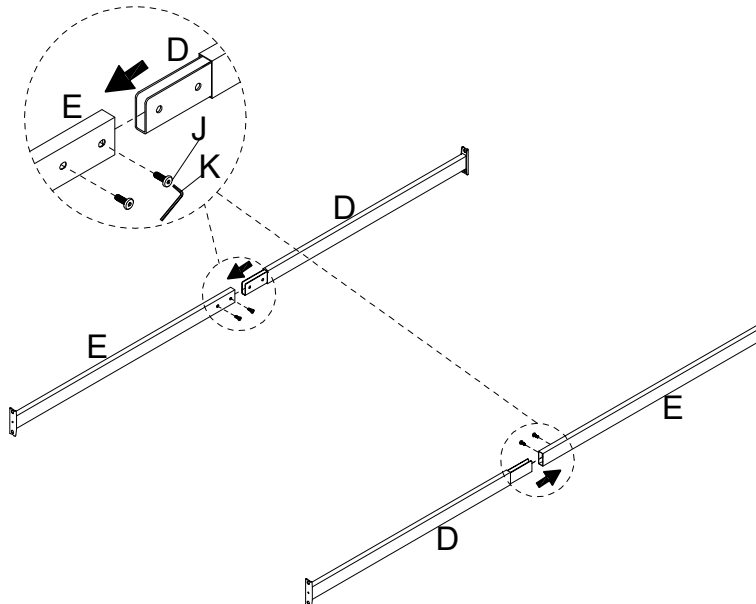
**3**

Attach the Front / Rear Support Bar (G) and Center Support Bar (F) to the Rails (D) & (E), insert the Bolt (J), turn the L-Allen Key (K) to tighten them.

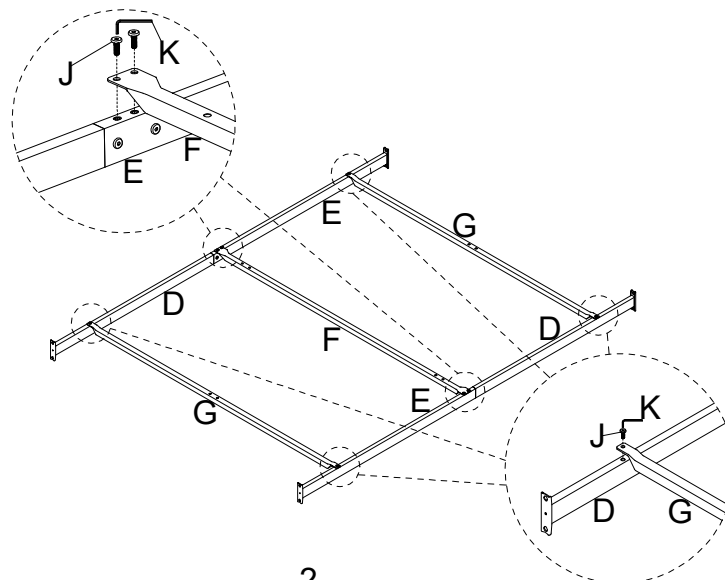

**4** Attach the Support Leg (H) to the Front / Rear Support Bar (G) and Center Support Bar (F), insert the Bolt (J), turn the L-Allen Key (K) to tighten them.

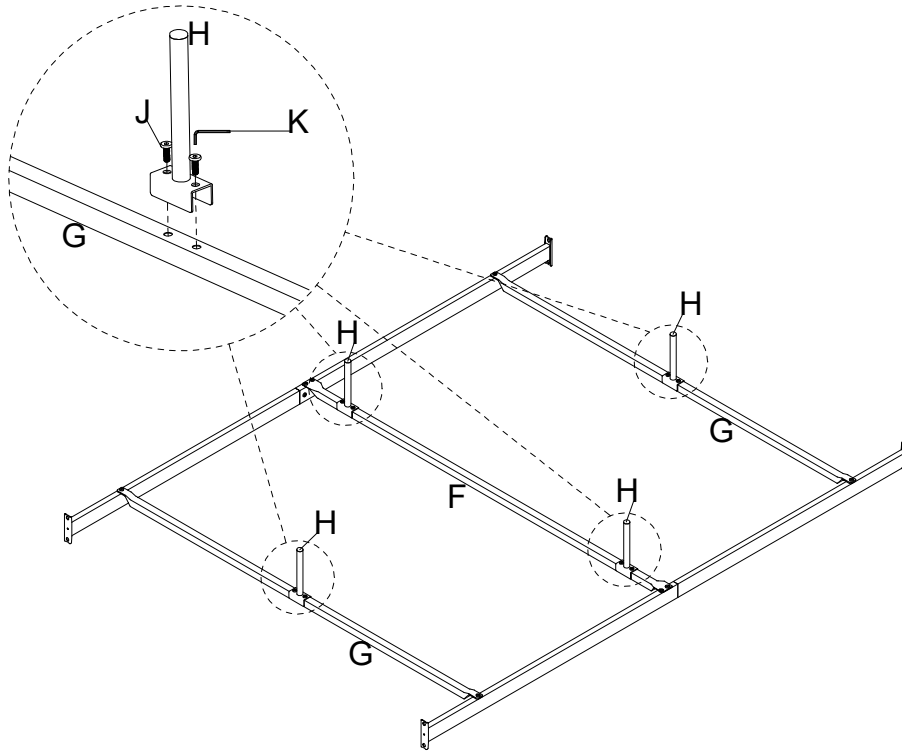

**5** Attach the Rails (D) & (E) to the Headboard Leg (A) and Footboard (C), insert the Bolt (I), turn the L-Allen Key (K) to tighten them.

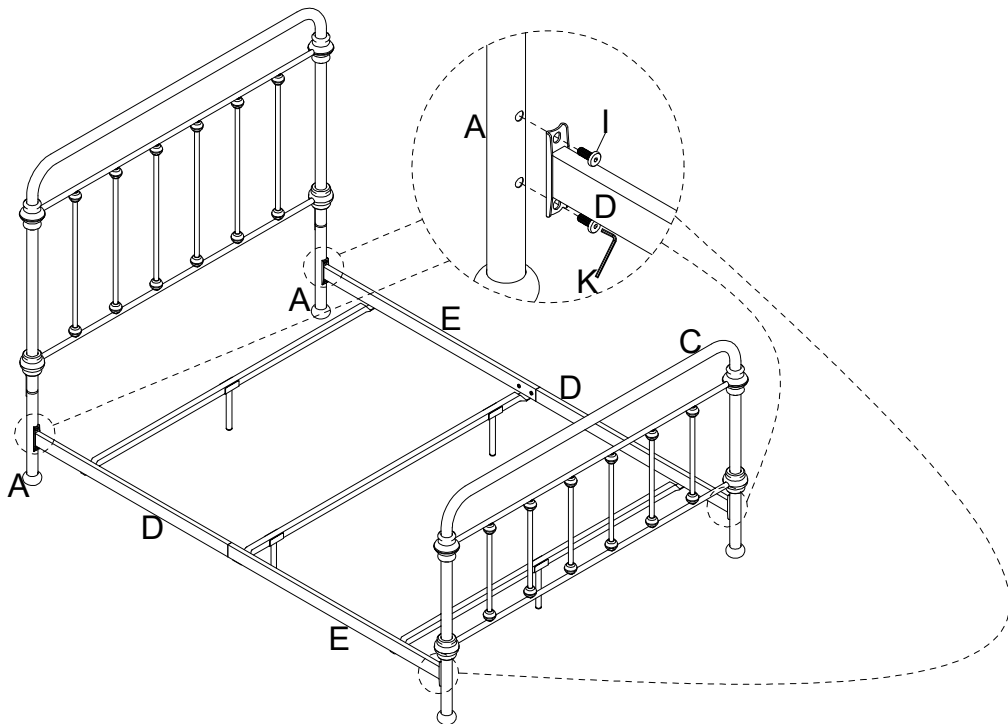

### Cleaning & Care

Treat surface with care. Surface is resistant to scratches but is not scratch resistant. Clean surfaces with a dry or damp soft cloth. Do not use abrasive cleaners. Hardware may loosen over time. Periodically check that all connections are tight.