

DVD Storage

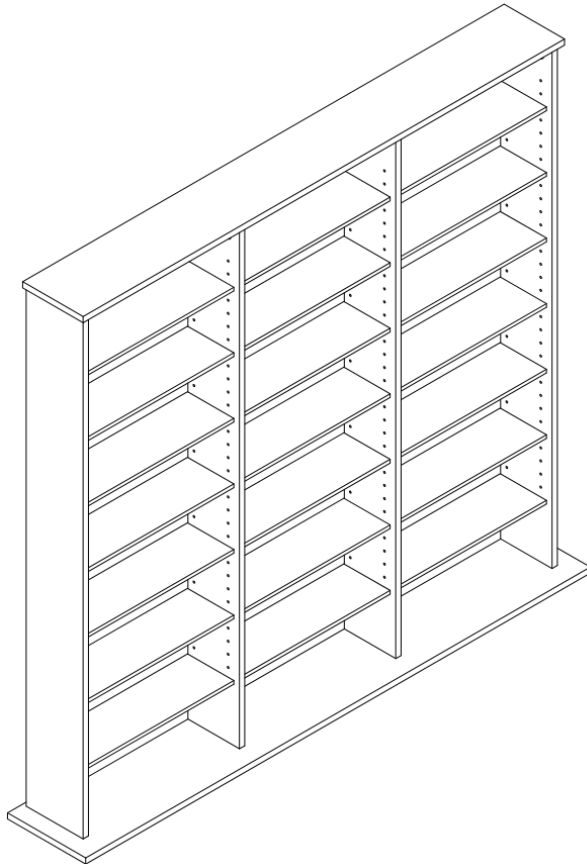

This is the original instruction, please read all manual instructions carefully before operating. We reserves a clear interpretation of our user manual. The appearance of the product shall be subject to the product you received. Please forgive us that we won't inform you again if there are any technology or software updates on our product.

WARNING:

Please read this manual carefully before using the product. Failure to do so may result in serious injury.



Please read and observe carefully all the assembly instructions before beginning assembly.



Unit should be assembled by two or more people.



DO NOT CLIMB

Please do not let your child climb on the product. If you have kids or animals who like to climb, we highly recommend using the wall anchors and brackets/straps that come with the package.

ASSEMBLY PRECAUTIONS

1. Assemble only according to these instructions. Improper assembly can create hazards.
2. Wear ANSI-approved safety goggles and heavy-duty work gloves during assembly.
3. Keep the assembly area clean and well-lit.
4. Keep bystanders out of the area during assembly.
5. Do not assemble when tired or when under the influence of alcohol, drugs or medication.
6. The product capabilities apply to properly and completely assembled products only.

7. Assemble on a flat, level, hard and smooth surface capable of safely supporting the DVD Storage.

8. For additional information regarding the parts listed in the following pages, please refer to the Assembly Diagram of this manual. Unwrap and separate all parts in a clean work area.

SAVE THESE INSTRUCTIONS

USE PRECAUTIONS

TO PREVENT SERIOUS INJURY AND DEATH FROM TIPPING:

1. This product is not a toy. Do not allow children to play with or near this item.

2. Do not exceed weight capacities, before moving.

3. Use only on a flat, hard and smooth surface capable of safely supporting a fully loaded DVD Storage.

4. Use as intended only. Inspect before every use; do not use if parts are loose or damaged.

TECHNICAL SPECIFICATIONS

Model	01-Black	02-Brown
Color	Black	Brown
Product Dimensions (LxWxH)(mm)	1420*220*1300	
Net Weight(kg)	About 28	

*Products such as specifications, appearance, and design are subject to modification without prior notice.

Installation of Cams and Pins

Screw the pin into the hole. To set the cams correctly, ensure that the arrow on the cam is opening to the hole of the pin it is locking. Lock the cam by turning the cam head with a screwdriver until it is tightened. Please do not use an electric screwdriver to assemble the unit.

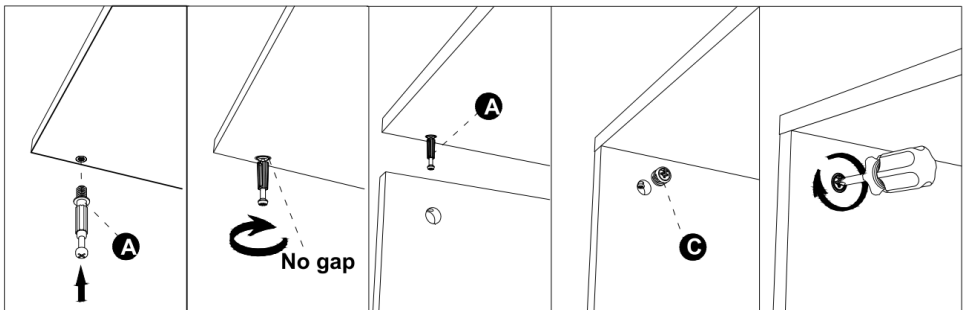

Read each step carefully before starting. It is very important that each step of instruction is performed in the correct order. If these steps are not followed in sequence, assembly difficulties will occur.

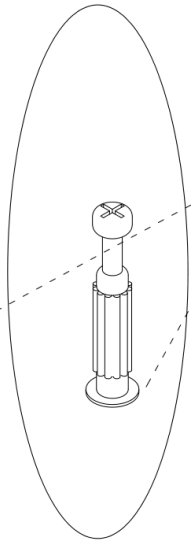
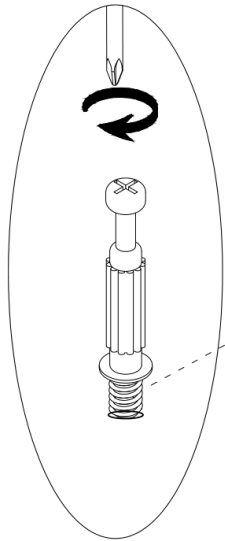
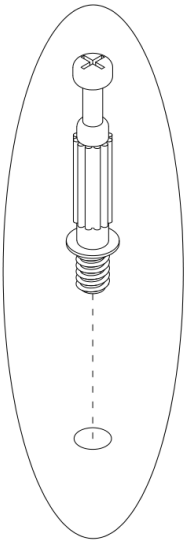

No gap



PACKAGE CONTENTS

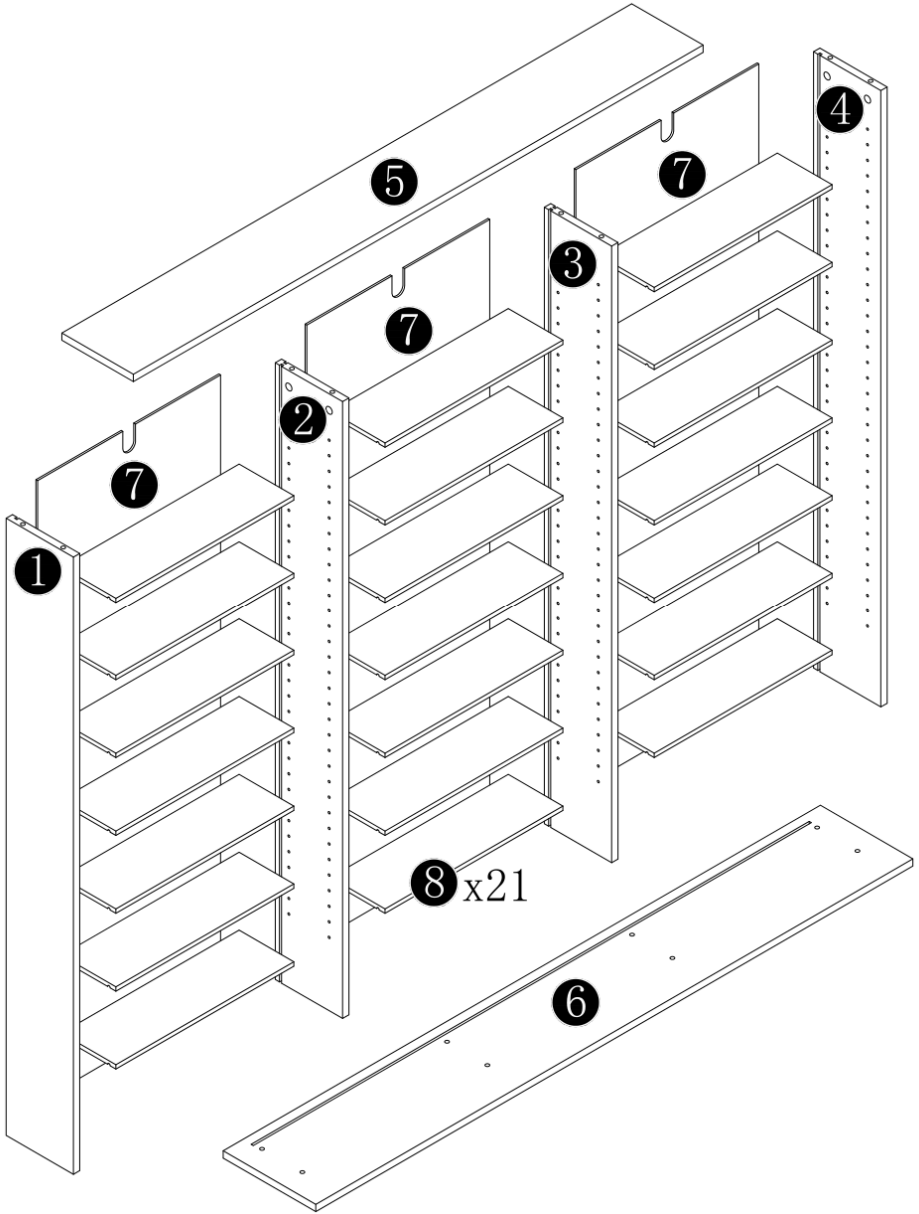

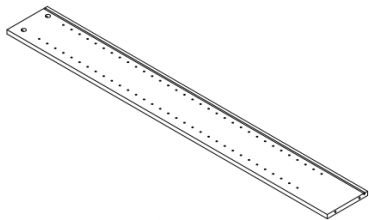

① 1pc

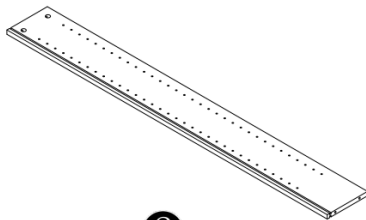

② 1pc

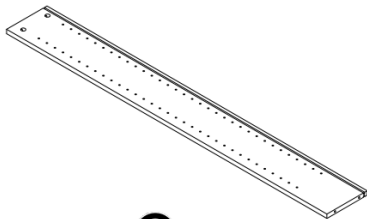

③ 1pc

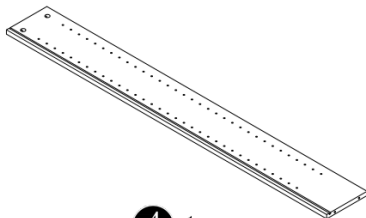

④ 1pc

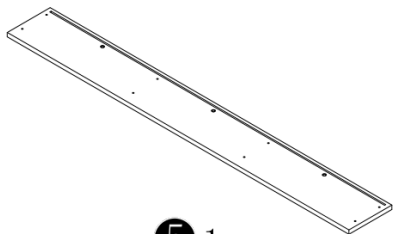

⑤ 1pc

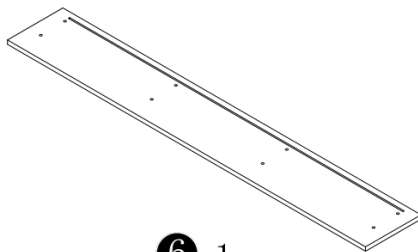



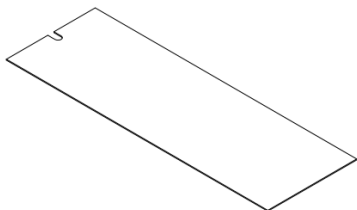



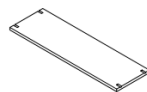



⑥ 1pc



⑦ 3pcs

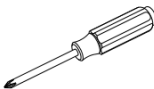

⑧ 21pcs

 <p>A 8pcs</p>	 <p>M7x50MM B 8pcs</p>	 <p>C 8pcs</p>	 <p>M6x30MM D 8pcs</p>
 <p>M 1pc</p>	 <p>ST3. 5x12MM P 18pcs</p>	 <p>R 84pcs</p>	 <p>U 18pcs</p>
 <p>18CM Z 3pcs</p>			

ASSEMBLY STEPS

1

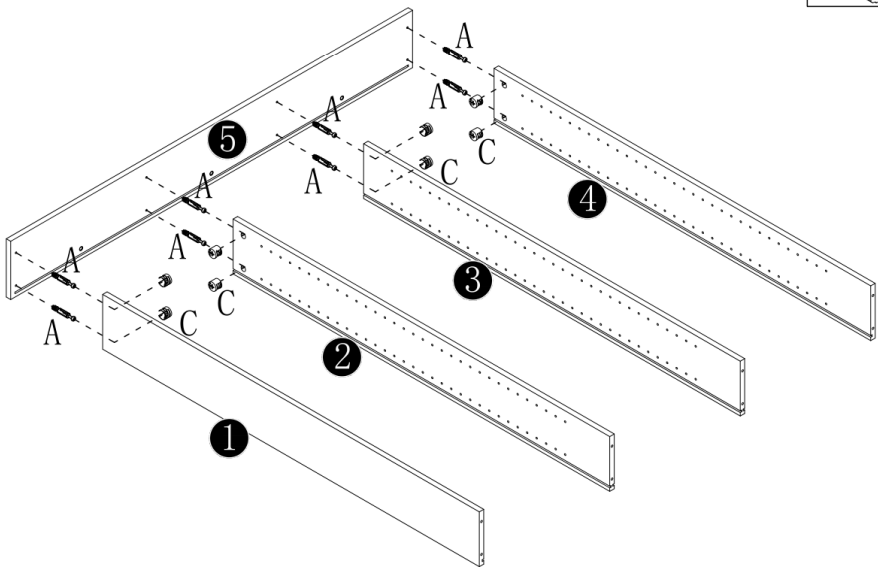
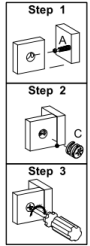
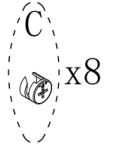
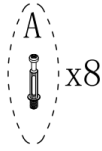

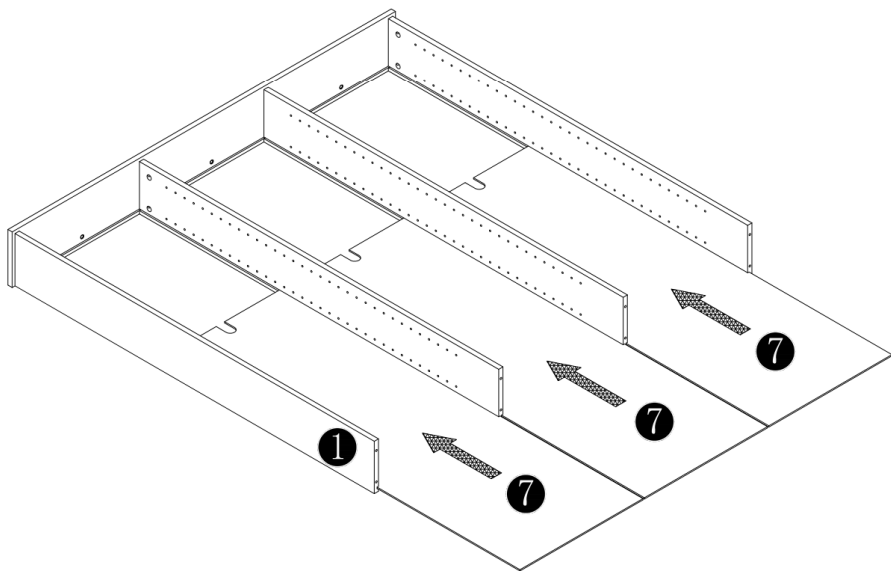

3

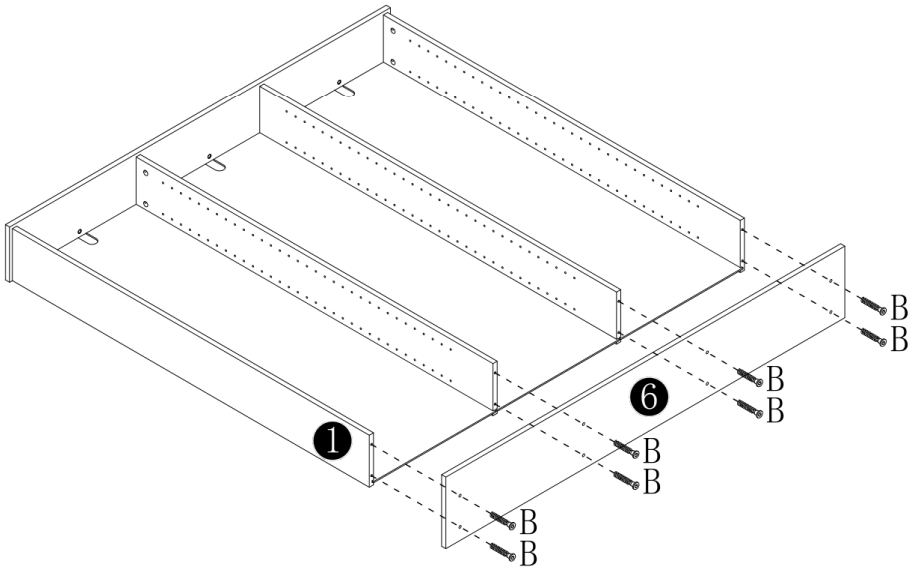
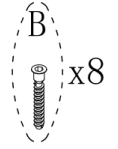

5

⚠ WARNING	
	<p>Children have died from furniture tipover. To reduce the risk of furniture tipover:</p> <ul style="list-style-type: none">-ALWAYS install Anti-tip device provided-NEVER climb, stand, or sit on the unit. It is not designed to support human weight-DO NOT overload shelves, tops, or bases. Place heaviest items in the lowest cubes.-DO NOT stack multiple units. Each must be anchored individually.

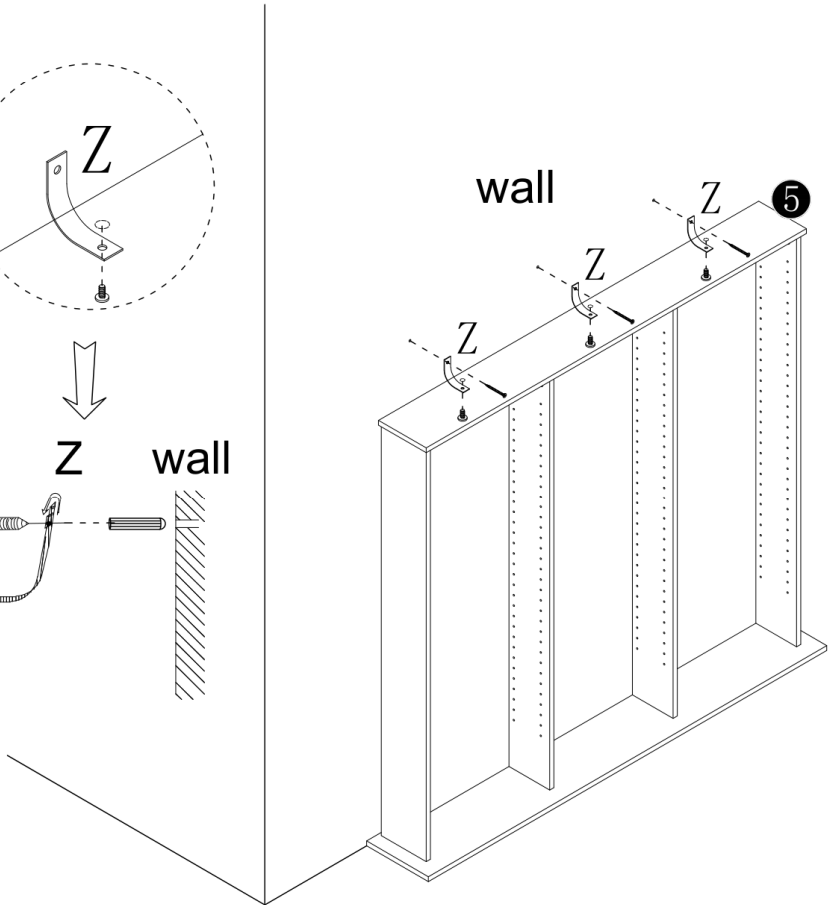
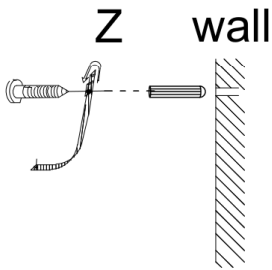
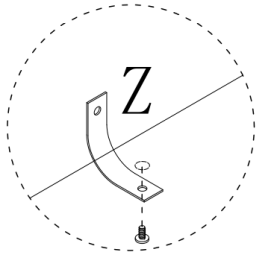
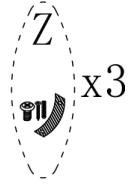

6

Adjust the height according to the requirements

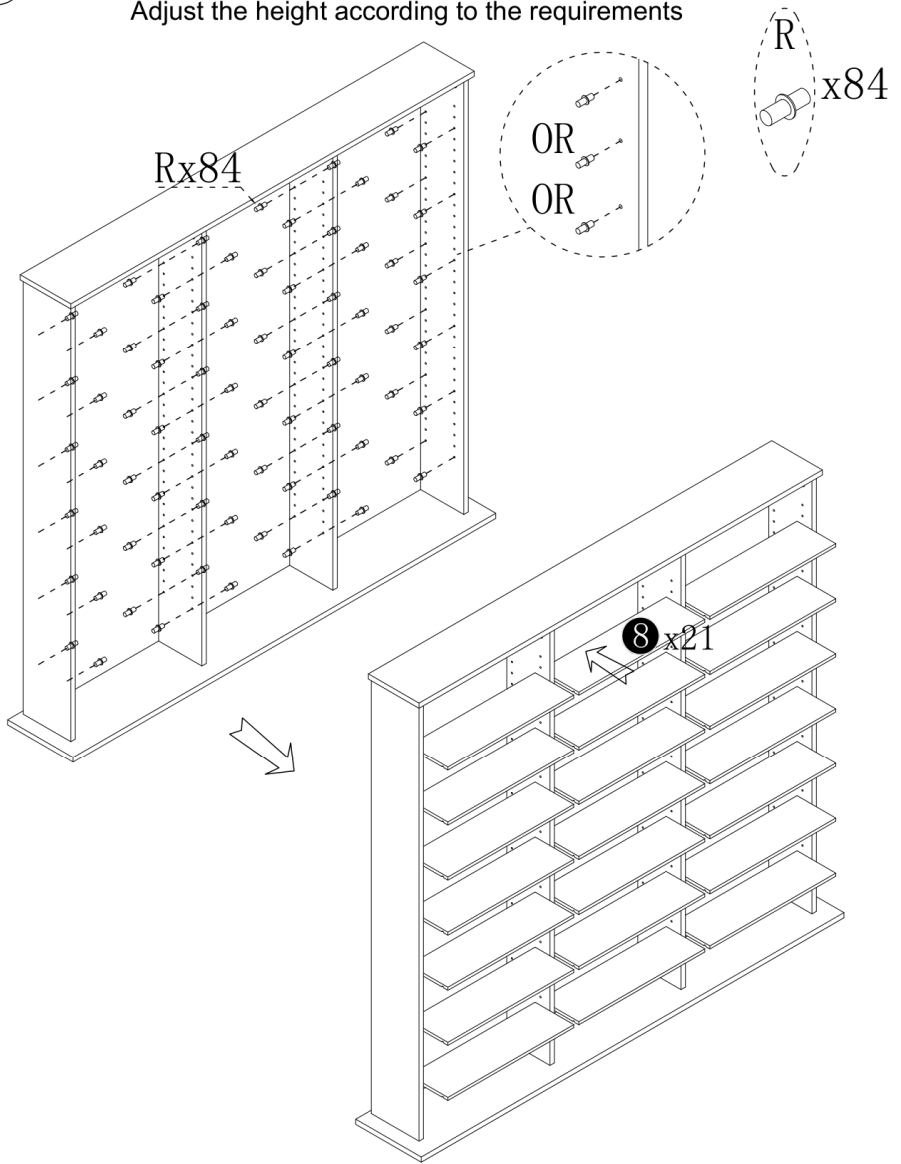

7

Write the product classification on M number, and affix it to the 8th layer board as a product categorization label for classification and identification

