

# ASSEMBLY INSTRUCTIONS

## FULL OVER FULL BUNK BED

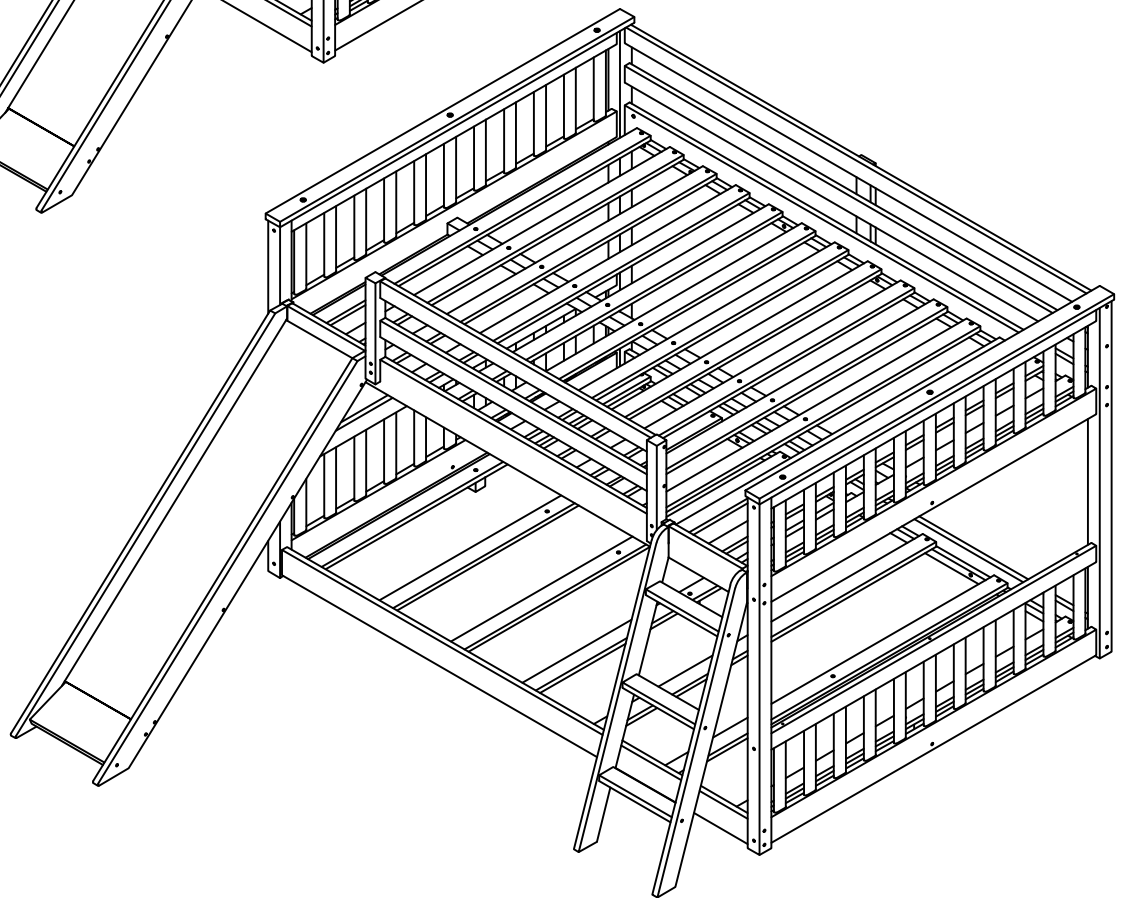

# ASSEMBLY INSTRUCTIONS

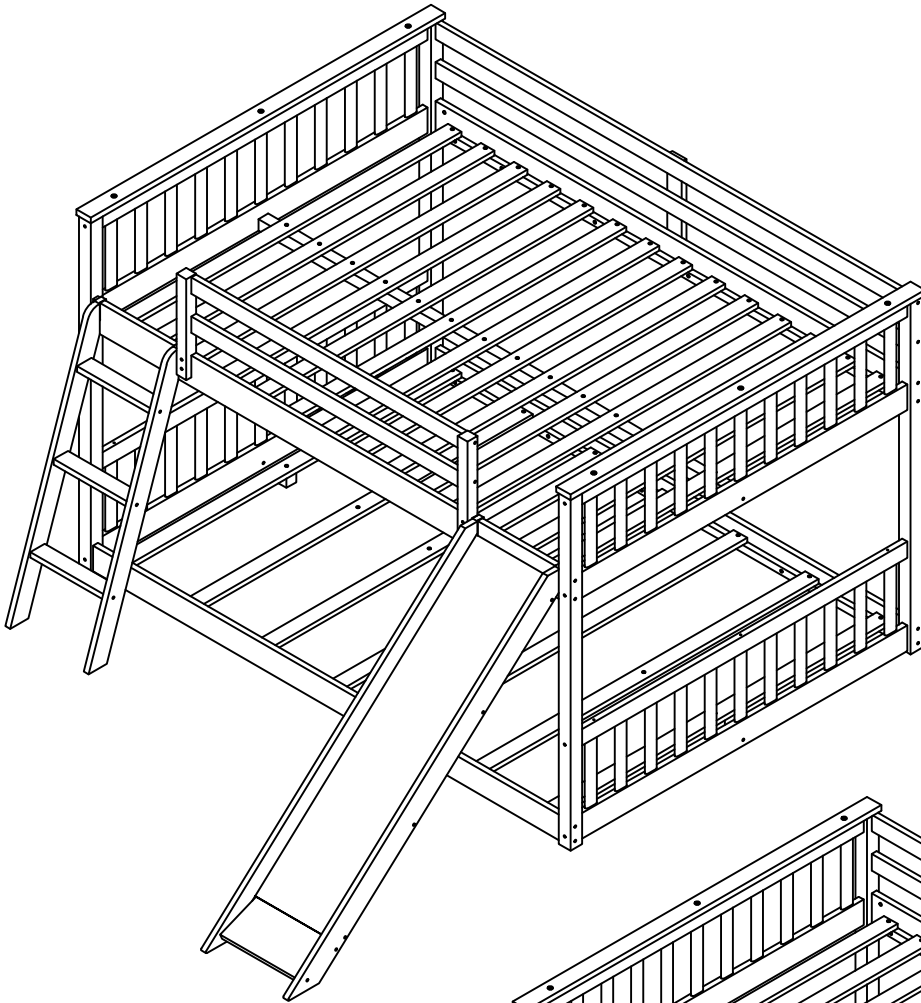
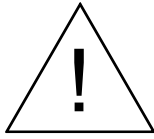

## **SAFETY WARNINGS**



1. This bed is designed for use only mattress (es) meeting the following specifications on the upper bunk, and lower bunk:

**Upper bunk (bunk bed and tribed included)**

<b>Bed Type</b>	<b>Length</b>	<b>Width</b>	<b>Thickness</b>
Full Standard	74" - 75"	53" - 54"	6" max

**Lower bunk**

<b>Bed Type</b>	<b>Length</b>	<b>Width</b>	<b>Thickness</b>
Full Standard	74" - 75"	53" - 54"	8"

2. Replacement parts, including additional guardrails, maybe obtained from any of our (GIGACLOUD TECHNOLOGY (USA) INC. 18961 ARENTH AVENUE CITY OF INDUSTRY, CA, 91748) dealers
3. Follow the information on the warnings appearing on the upper bunk bed end structure and on the carton. Do not remove warning label from bed.
4. Always use the recommended size mattresses or mattress supports, or both, to help prevent the likelihood of entrapment or falls.
5. Surface of mattress must be at least 5" (127mm) below the upper edge of guardrails.
6. Do not allow children under 6 years of age to use the upper bunk.
7. Periodically check and ensure that the guardrail, ladder, and other components are in their proper position, free from damage, and that all connectors are tight.
8. Do not allow horseplay on or under the bed and prohibit jumping on the bed.
9. Always use the ladder for entering and leaving the upper bunk.
10. Do not use substitute part. Contact the manufacture or dealer for replacement part.
11. Use of a night light may provide added safety precaution for a child using the upper bunk.
12. Always use guardrails on both long sides of the upper bunk. If the bunk bed will be placed next to the wall, the guardrail that runs the full length of the bed should be placed against the wall to prevent entrapment between the bed and wall.
13. The use of water or sleep flotation mattresses is prohibited.
14. **STRANGULATION HAZARD** - Never attach or hang items to any part of the bunk bed that are not designed for use with the bed; for example, but not limited to, hook, belts and jump ropes.
15. Keep these instruction for future reference.
16. Prohibit more than one person on upper bunk
17. We recommend assembling your bunk bed on the shipping carton to protect your floor or carpet.
18. Be certain all staples are out of the box before beginning assembly on the shipping carton.

# ASSEMBLY INSTRUCTIONS

1. At the beginning :

Tighten all hardware.

Check metal parts for rust. If found, sand and repaint using a non-lead-based paint meeting the requirements of 16 CFR 1303.

Check all wood members for deterioration and splinters. Sand down splinters and replace deteriorating wood members.

Rake and check depth of loose fill protective surfacing materials to prevent compaction and to maintain appropriate depth. Replace as necessary.

2. Twice a month

Tighten all hardware.

Rake and check depth of loose fill protective surfacing materials to prevent compaction and to maintain appropriate depth. Replace as necessary.

3. Owners shall be responsible for maintaining the legibility of the warning labels.

4. Disposal Instructions-

There shall be instructions advising the owner to disassemble and dispose of the playground equipment in such a way that no unreasonable hazards will exist at the time the playground equipment is discarded.

5. The instructions shall also include the information found in Section 4 of the United States Consumer Product Safety Commission's (USCPSC) Outdoor Home Playground Safety Handbook or specific surfacing guidelines for the product consistent with the USCPSC Handbook. A copy of this section may be found in Appendix X2.

6. Observing the following statements and warnings reduces the likelihood of serious or fatal injury.

7. Specifying the number and weight of occupants that may safely use the equipment singly or simultaneously,

8. Recommending on-site adult supervision for children of all ages,

9. Warning the owner to instruct children not to use the equipment in a manner other than intended,

10. Warning the owner to instruct children not to get off equipment while it is in motion,

11. Warning the owner not to allow children to wear inappropriate items, such as but not limited to, loose fitting clothing, hood and neck drawstrings, scarves, cord-connected items, capes and ponchos. These items can cause death by strangulation.

12. Warning the owner to instruct children not to climb when the equipment is wet.

13. Warning the owner to instruct children not to attach items to the playground equipment that are not specifically designed for use with the equipment, such as, but not limited to, jump ropes, clothesline, pet leashes, cables and chain as they may cause a strangulation hazard

14. Warning the owner to instruct children to remove their bike or other sports helmet before playing on the playground equipment.

15. Warning the owner to dress children with well-fitting and full foot enclosing footwear. Examples of inappropriate footwear are clogs, flip flops, and sandals.

16. Place the equipment on level ground, not less than 6 ft (1.8 m) from any structure or obstruction such as a fence, garage, house, overhanging branches, laundry lines, or electrical wires

17. Do not install home playground equipment over concrete, asphalt, packed earth, grass, carpet, or any other hard surface. A fall onto a hard surface can result in serious injury or death to the equipment user

18. To prevent serious injury, cautionary statements shall be included which warn that children must not use the equipment until properly installed.

# ASSEMBLY INSTRUCTIONS

## DETAIL VIEW

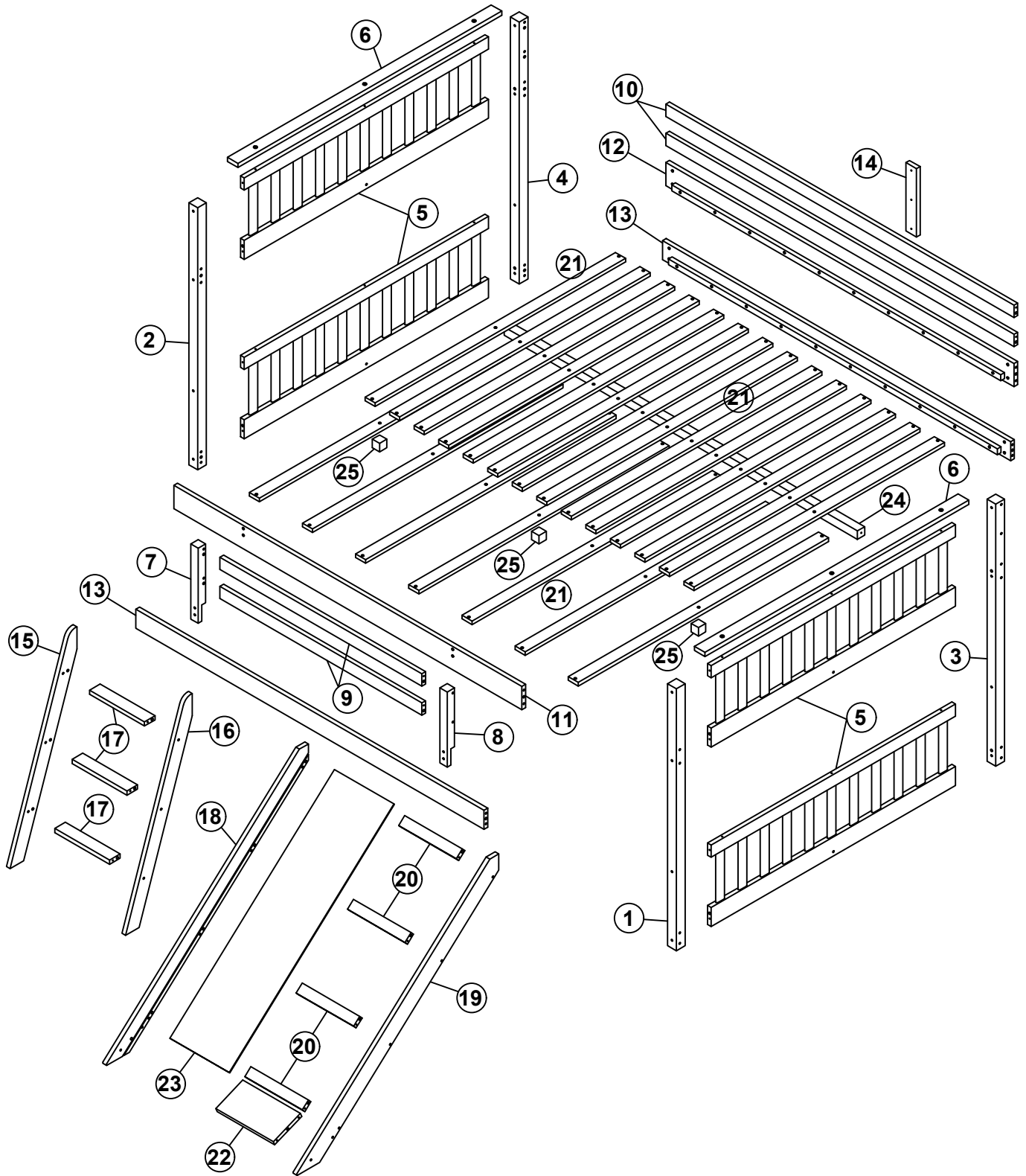





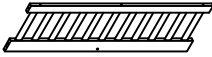
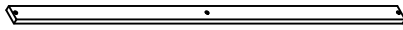

# ASSEMBLY INSTRUCTIONS

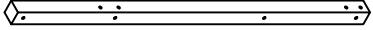
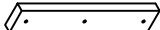
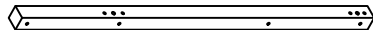
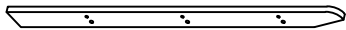
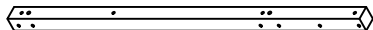
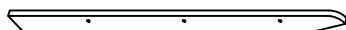
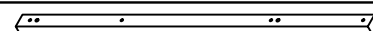
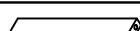
## PARTS LIST

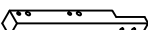
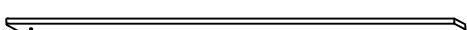
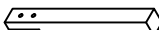
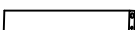
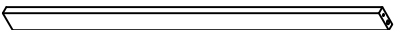
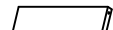
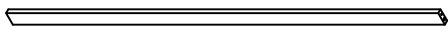

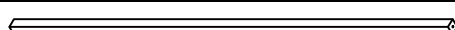
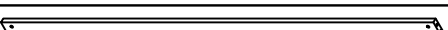

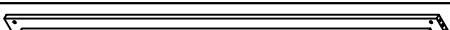



<b>5</b>	 Headboard frames	4pcs	<b>21</b>	 Slats (upper 14pcs / lower 7pcs)	21pcs
----------	---	------	-----------	---	-------

## PARTS LIST ( Hardware in this SKU)

<b>1</b>	 Right front leg	1pc	<b>14</b>	 Back guard rails support	1pc
<b>2</b>	 Left front leg	1pc	<b>15</b>	 Left stair side or left stair side	1pc
<b>3</b>	 Right back leg	1pc	<b>16</b>	 Right stair side or left stair side	1pc
<b>4</b>	 Left back leg	1pc	<b>17</b>	 Step stair sides	3pcs
<b>6</b>	 Headboard top panels	2pcs	<b>18</b>	 Slide left leg	1pc
<b>7</b>	 Left guard rails support	1pc	<b>19</b>	 Slide right leg	1pc
<b>8</b>	 Right guard rails support	1pc	<b>20</b>	 Slide supports	4pcs
<b>9</b>	 Top & bottom guard rails support	2pcs	<b>22</b>	 Slide bottom panel	1pc
<b>10</b>	 Top & bottom back bar	2pcs	<b>23</b>	 Slide panel	1pc
<b>11</b>	 Upper bed-Front side rail	1pc	<b>24</b>	 Upper bed-Center rail	1pc
<b>12</b>	 Upper bed-Back side rail	1pc	<b>25</b>	 Lower bed-Center rails	3pcs
<b>13</b>	 Lower bed-side rails	2pcs			

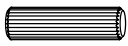

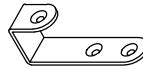

# ASSEMBLY INSTRUCTIONS

## HARDWARE LIST

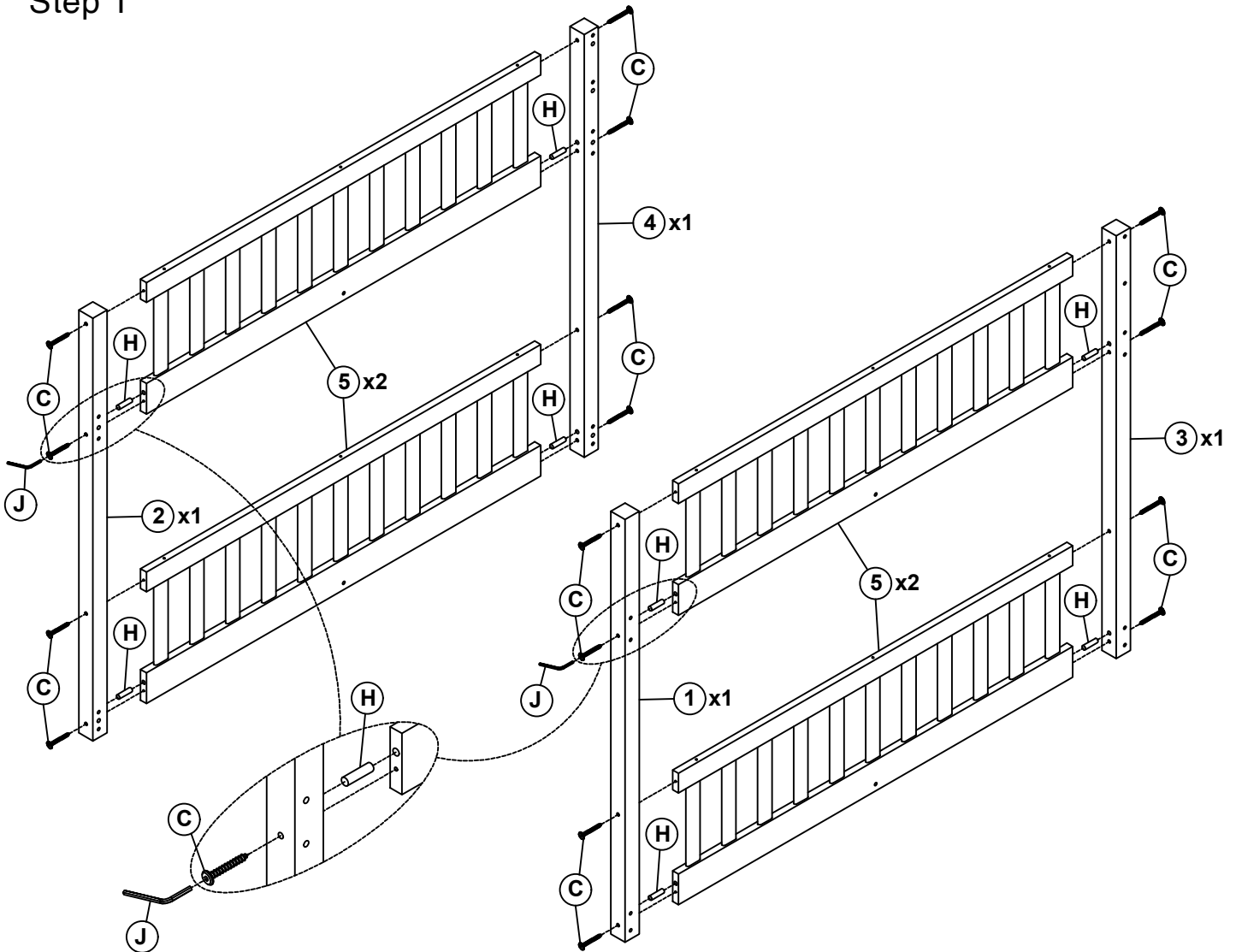
<b>A</b>	Ø4x30		62PCS	<b>F</b>	1/4x90		16PCS
<b>B</b>	Ø4x15		12PCS	<b>G</b>	1/4x35		4PCS
<b>C</b>	6.5x90		20PCS	<b>H</b>	Ø10x40		40PCS
<b>D</b>	6.5x80		4PCS	<b>I</b>	70x26x18		4PCS
<b>E</b>	6.5x60		26PCS	<b>J</b>	4x58		1PC

### Step 1



<b>J</b>	4x58		1PC	<b>J</b>	4x58		1PC
<b>C</b>	6.5x90		16PCS	<b>H</b>	Ø10x40		8PCS

# ASSEMBLY INSTRUCTIONS

## Step 2

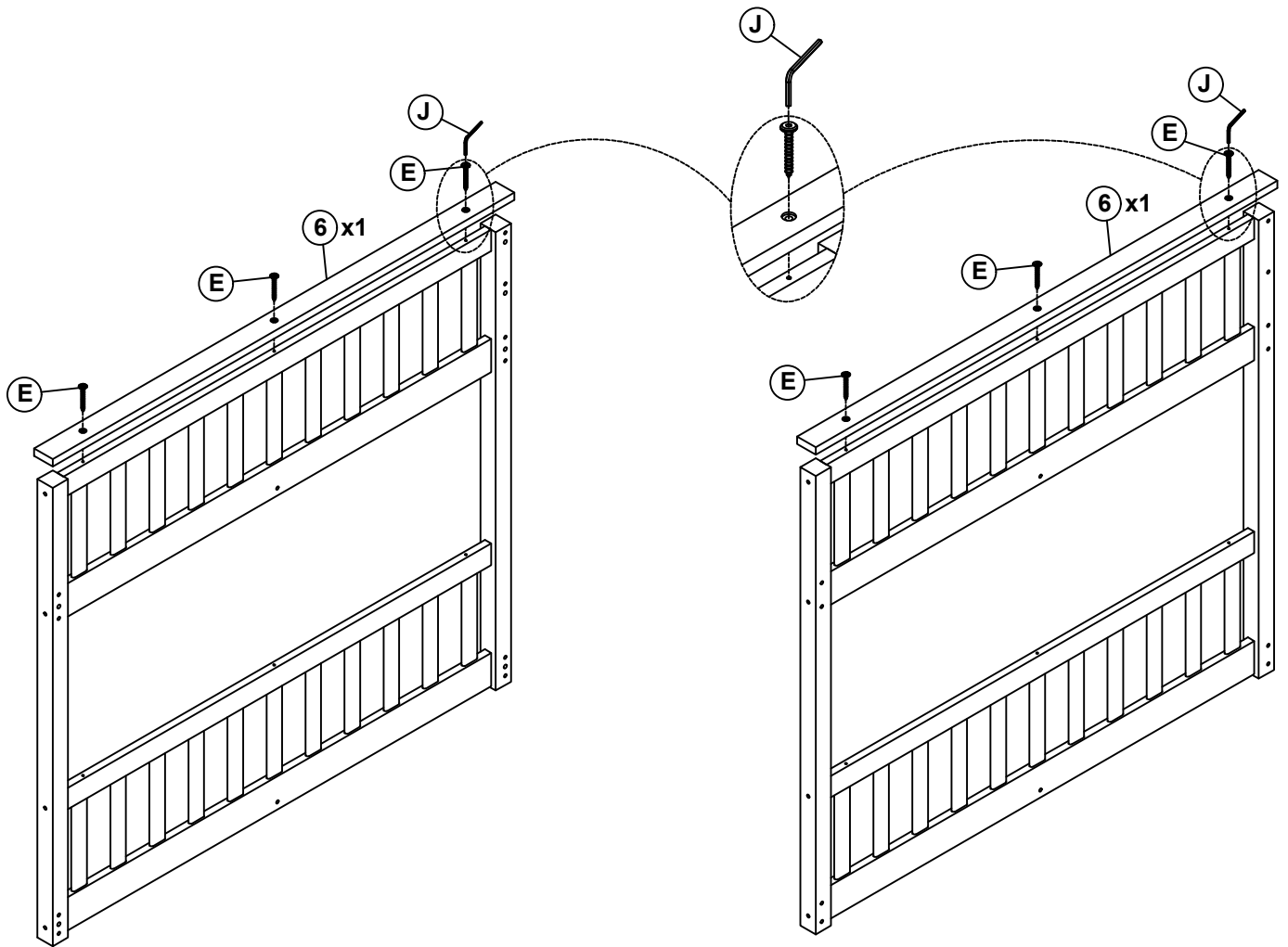

**J** 4x58



1PC

**E** 6.5x60





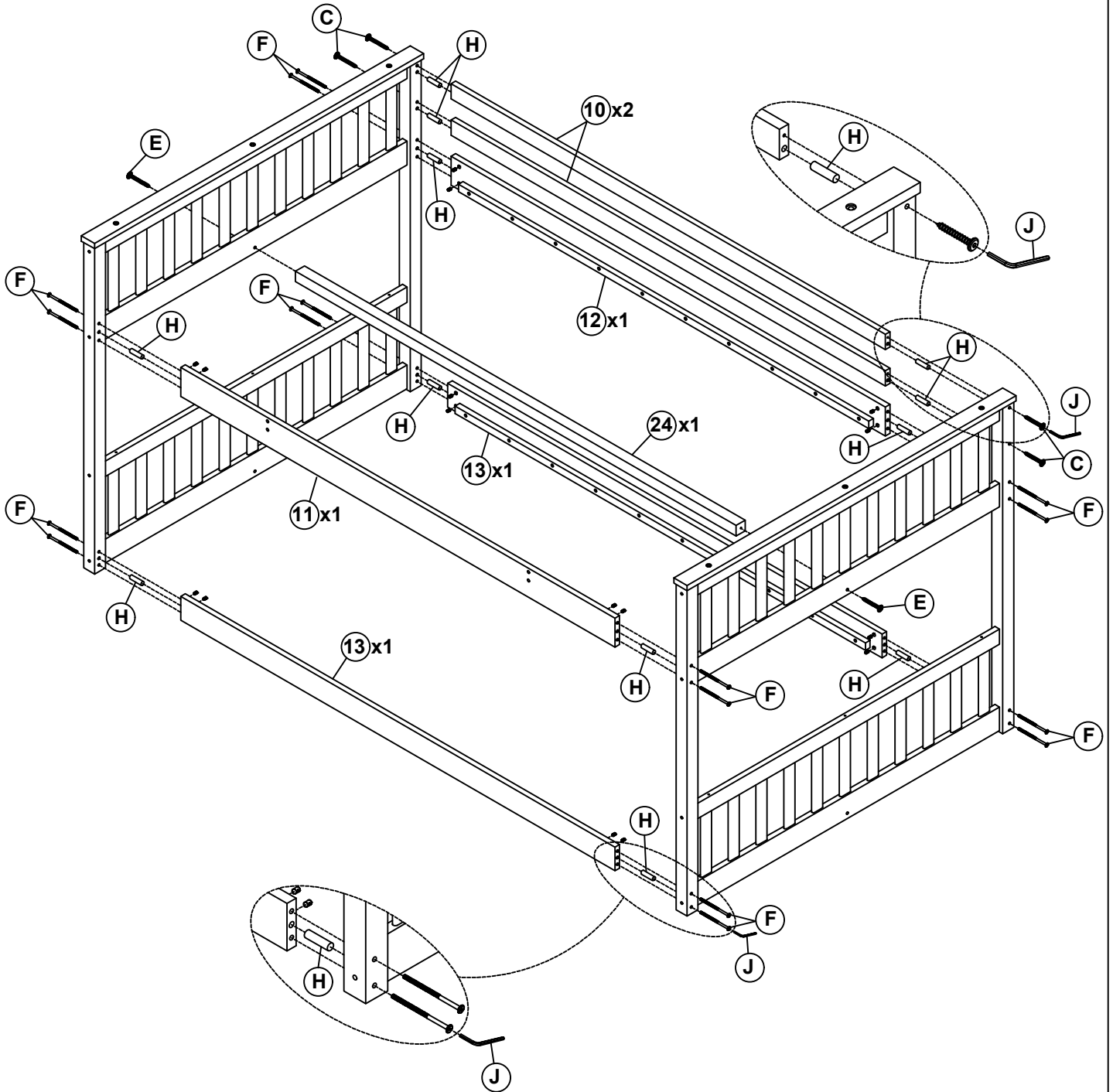

6PCS

# ASSEMBLY INSTRUCTIONS

## Step 3





				<b>J</b>	4x58		1PC
<b>E</b>	6.5x60		2PCS	<b>F</b>	1/4x90		16PCS
<b>C</b>	6.5x90		4PCS	<b>H</b>	Ø10x40		12PCS

# ASSEMBLY INSTRUCTIONS

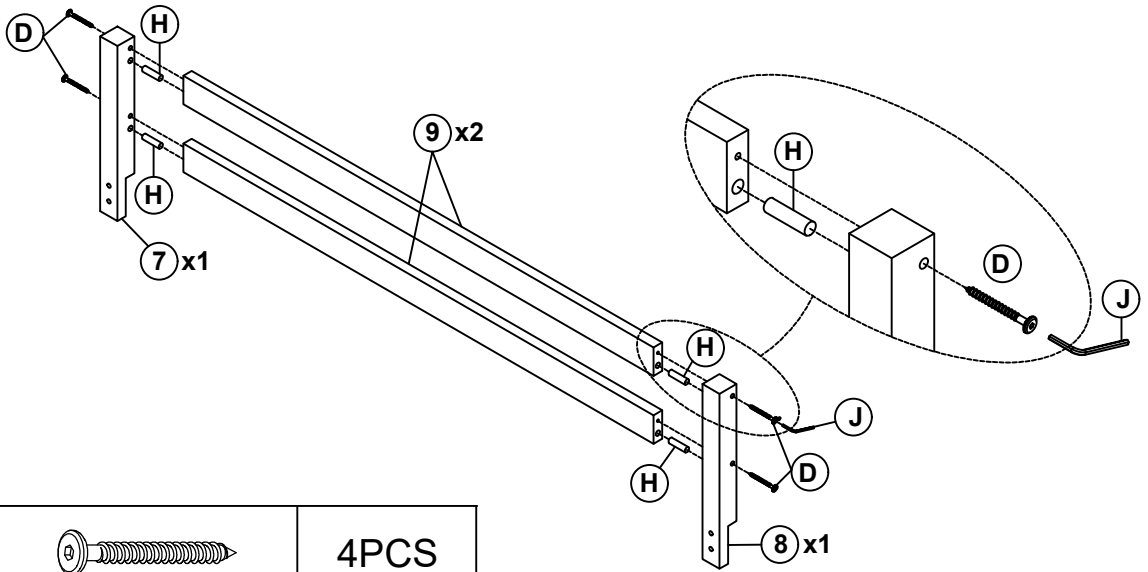

Step 4

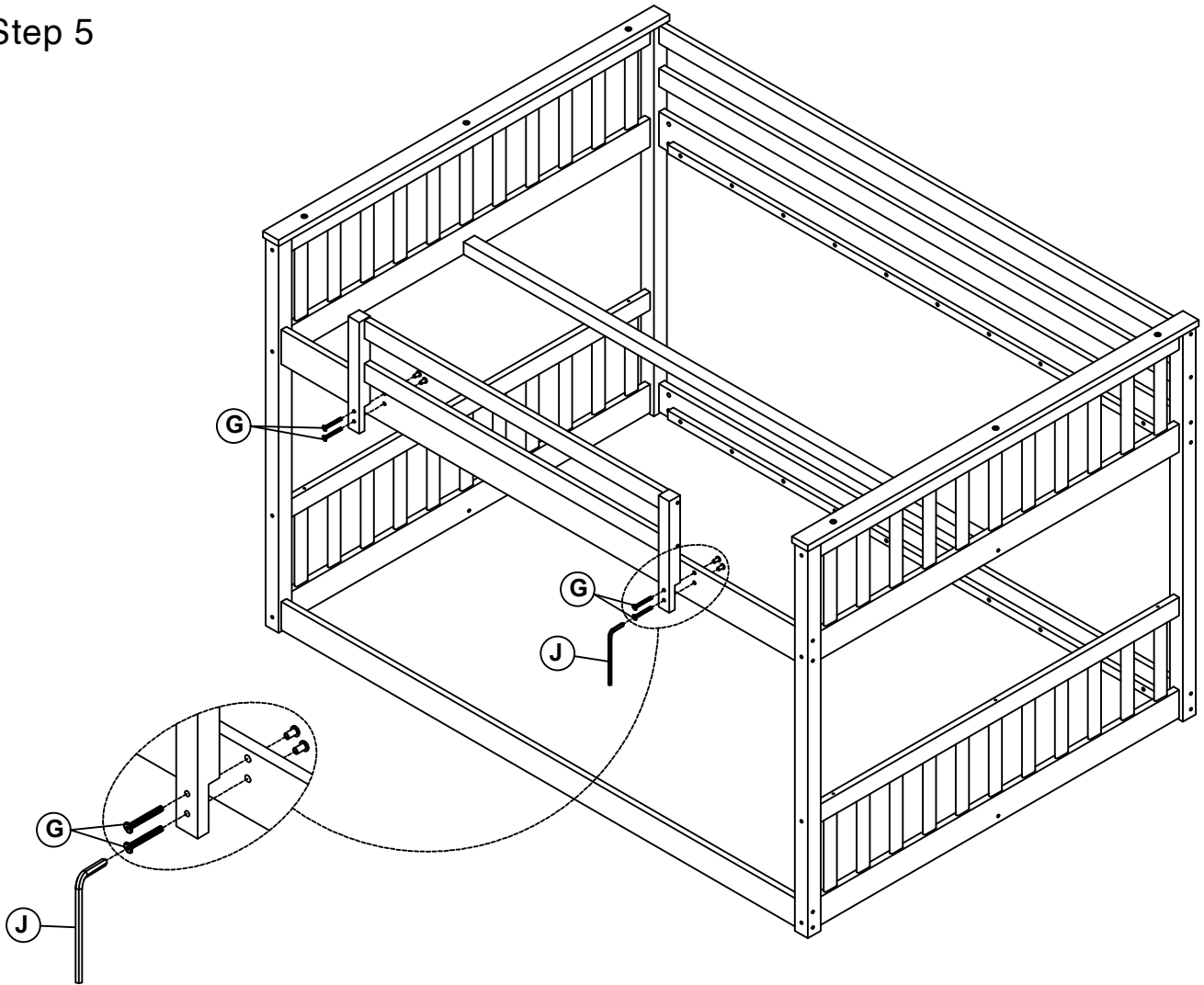

<b>D</b>	6.5x80		4PCS			
<b>H</b>	Ø10x40		4PCS	<b>J</b>	4x58	
						1PC

Step 5



<b>G</b>	1/4x35		4PCS	<b>J</b>	4x58	
						1PC

# ASSEMBLY INSTRUCTIONS

## Step 6

First attach 2pcs part 21 to the front and end of the frame between headboard. Then attach the remaining part 21 equidistantly between headboard

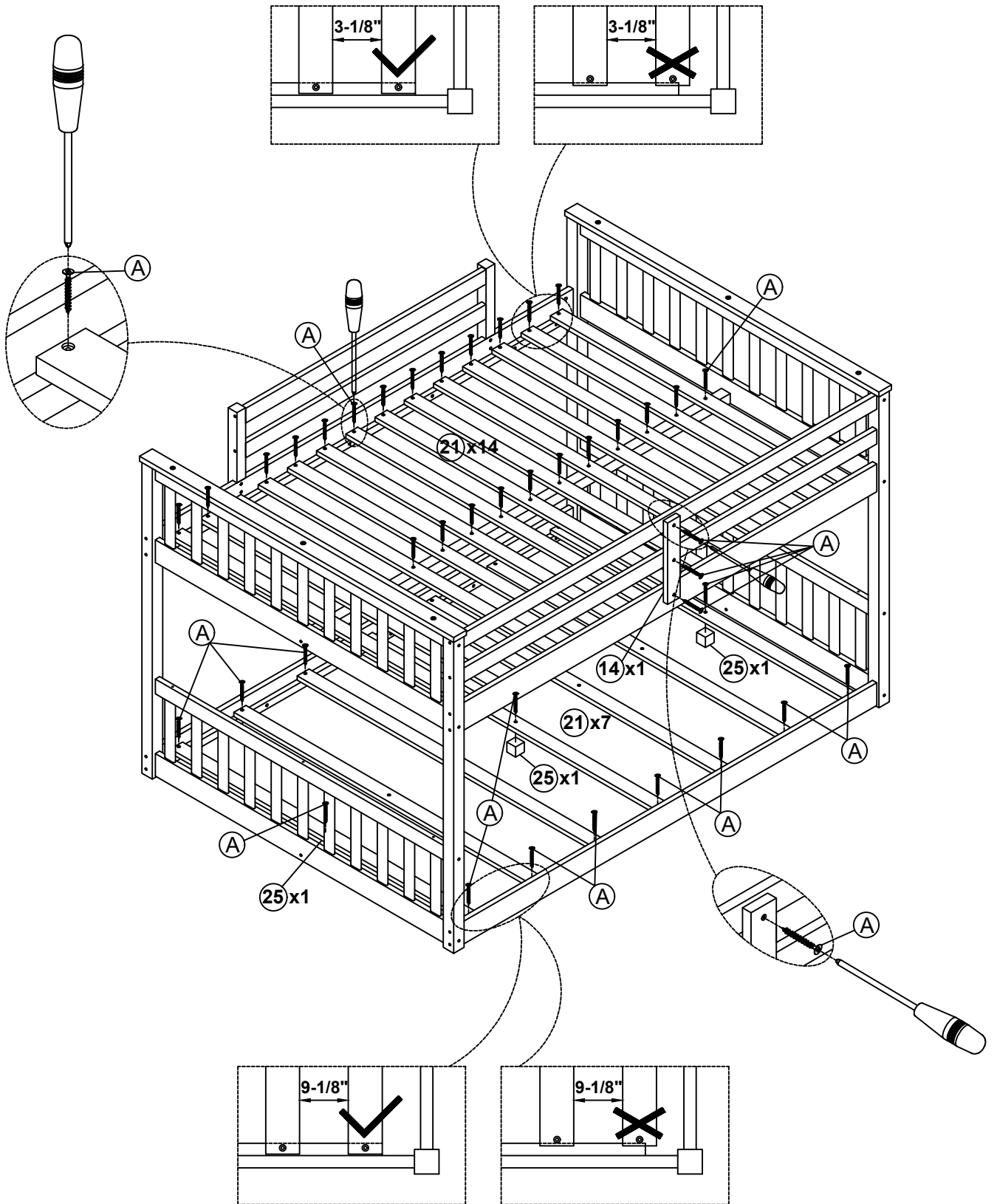

Note : Do not lock the screws of the bed slats to the outermost edge of the bed slats, you need to leave a certain space at the edges, otherwise it will cause the board to break

**A**

Ø4x30





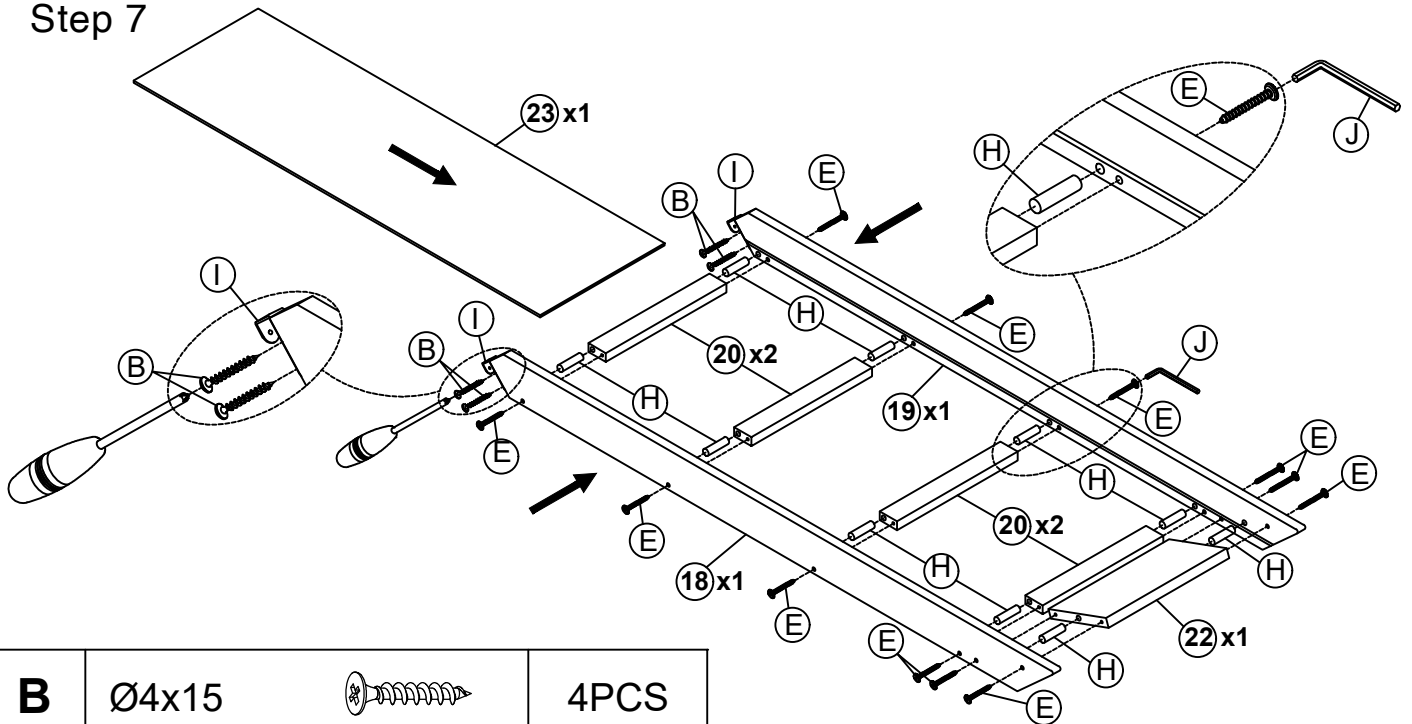

62PCS

# ASSEMBLY INSTRUCTIONS

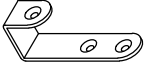



## Step 7

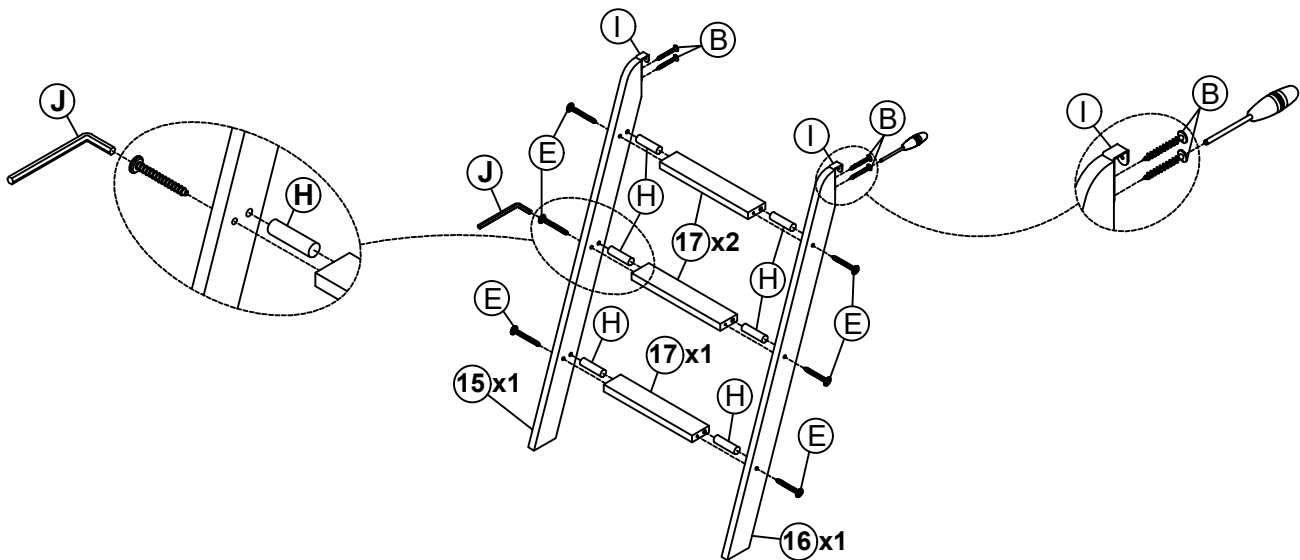

<b>B</b>	Ø4x15		4PCS				
<b>I</b>	70x26x18		2PCS	<b>J</b>	4x58		1PC
<b>H</b>	Ø10x40		10PCS	<b>E</b>	6.5x60		12PCS

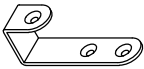
## Step 8



<b>B</b>	Ø4x15		4PCS				
<b>I</b>	70x26x18		2PCS	<b>J</b>	4x58		1PC
<b>H</b>	Ø10x40		6PCS	<b>E</b>	6.5x60		6PCS

# ASSEMBLY INSTRUCTIONS

Step 9

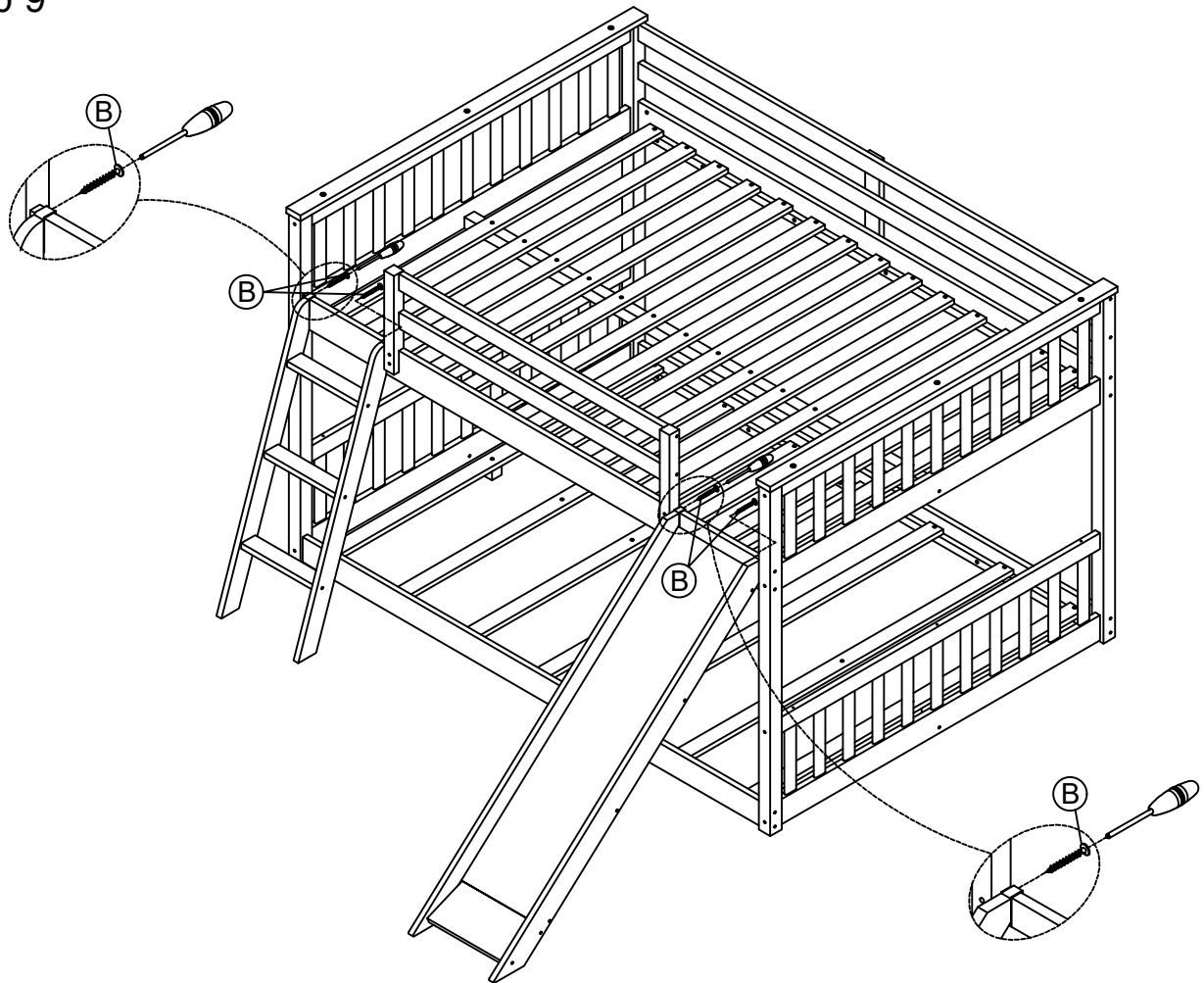

**B**

Ø4x15



4PCS