

INSTRUCTION MANUAL

60-Inch 4-Tier Storage Rack

(LY005)

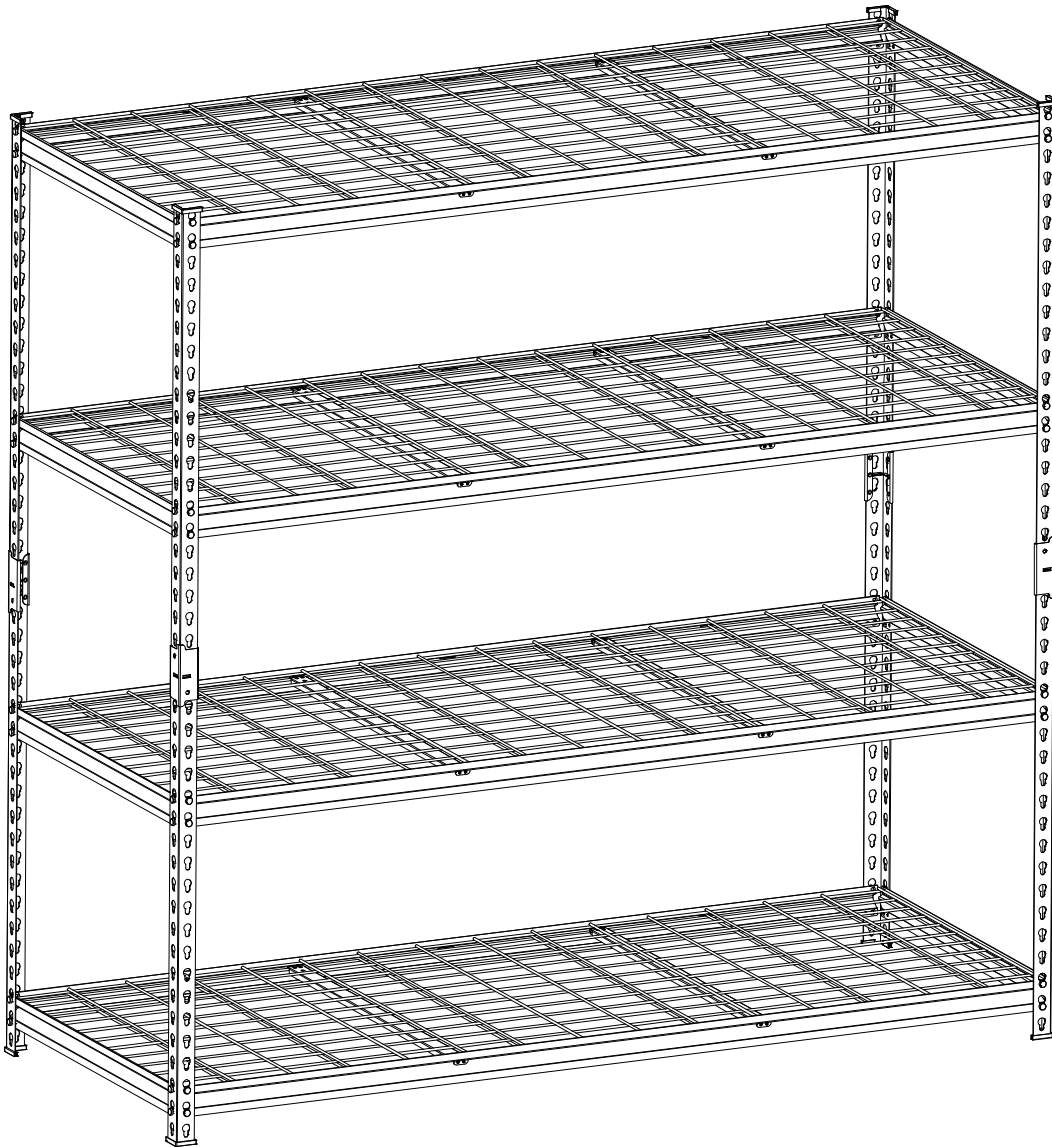



Customer Support

Phone: +1(986)-888-1726

Email: help@unified-support.com

Hours: Mon-Fri, 9:00 AM - 6:00 PM ET

WARNING!

	Warning - To reduce the risk of injury, user must read instructions manual carefully.
	This symbol, placed before a safety comment, indicates a kind of precaution, warning, or danger. Ignoring this warning may lead to an accident. To reduce the risk of injury, fire, or electrocution, please always follow the recommendation shown below.
	Warning- Be sure to wear gloves when using this product.

WARNING!

- (1) Keep this manual for the safety warnings and precautions. The manual offers important information on how to assemble, use and maintain this product.
- (2) Please handle metal edges carefully.
- (3) DO NOT stand on this product or use it as a ladder.
- (4) DO NOT alter this product in any manner that is not intended, as this may cause product damage or personal injury.
- (5) Always assemble on an even surface.
- (6) The maximum loaded weight for each shelf is no more than 600 LBS, evenly distributed.
- (7) Store the heaviest items on lower shelves.
- (8) Attach the unit to the wall if filling to capacity .

ASSEMBLY PRECAUTIONS

1. Please assemble the product in strict accordance with the instructions. Incorrect assembly could be hazardous.
2. Please wear goggles and work gloves correctly when assembling, place a piece of cloth or wood between the hammer head and the part, or use a rubber mallet.
3. Do not try to assemble the product when feeling tired or when under the influence of alcohol, drugs or medication.
4. Load bearing capacity and other product parameters are applied to the properly and completely assembled product only.



USE PRECAUTIONS

1. This product is not a toy. Do not allow children to play with or get access to this item.
2. Check carefully before use. Do not use if parts get loosened or damaged.
3. Use on flat, level, and hard surfaces only.
4. Do not exceed the listed load bearing capacity. Tighten all the knobs securely before placing weights on. Be aware of the dynamic load bearing capacity! Sudden load changes may temporarily cause excessive load, resulting in product failure.

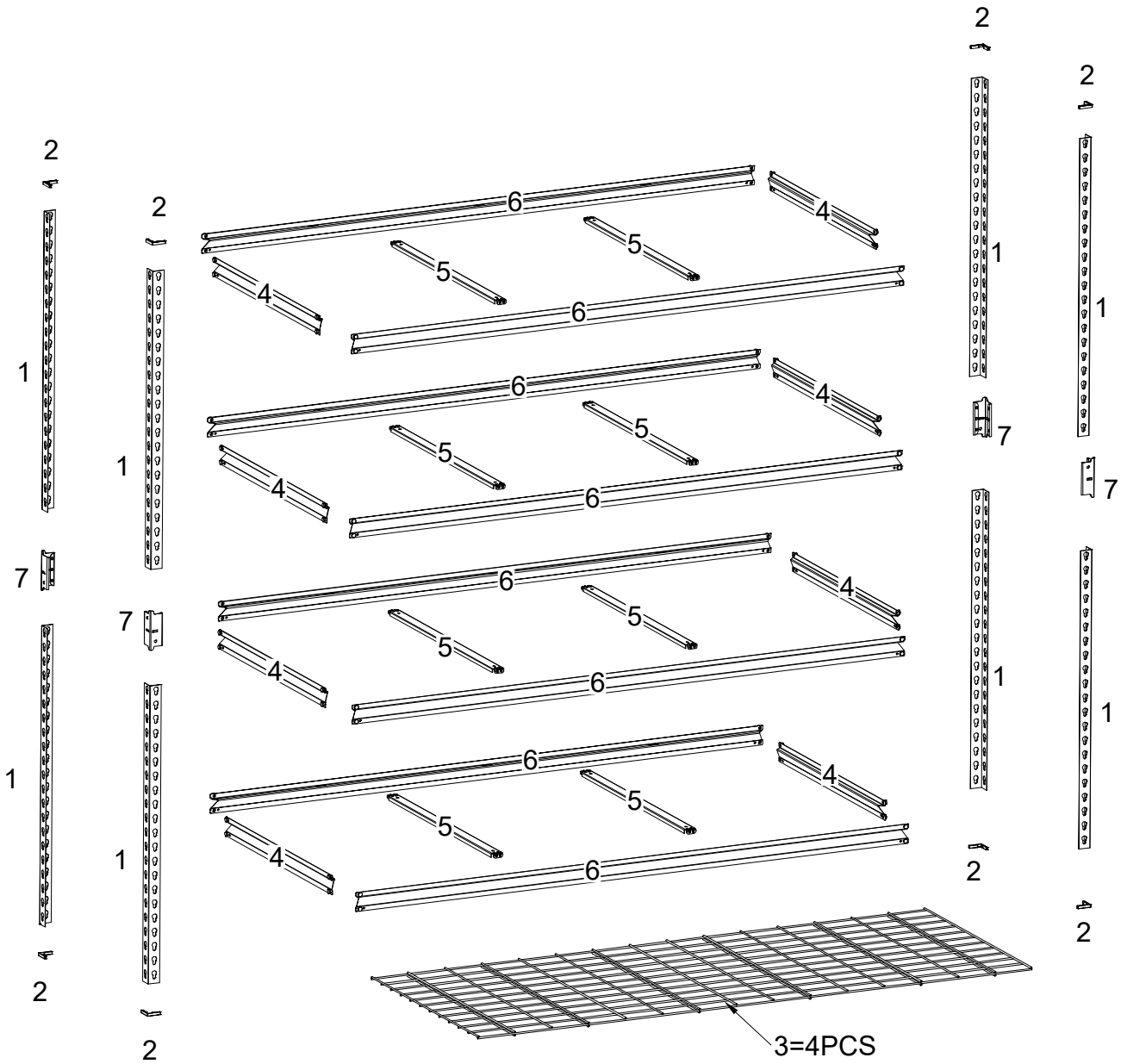
Parts List

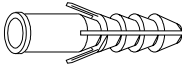

Hardware List

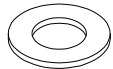
A		Expansion plastic plug	2 PCS
B		Screw	2 PCS
C		Washer	2 PCS

Step 1

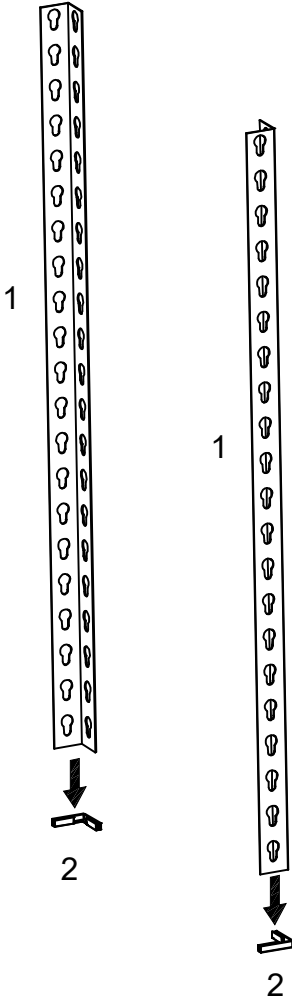
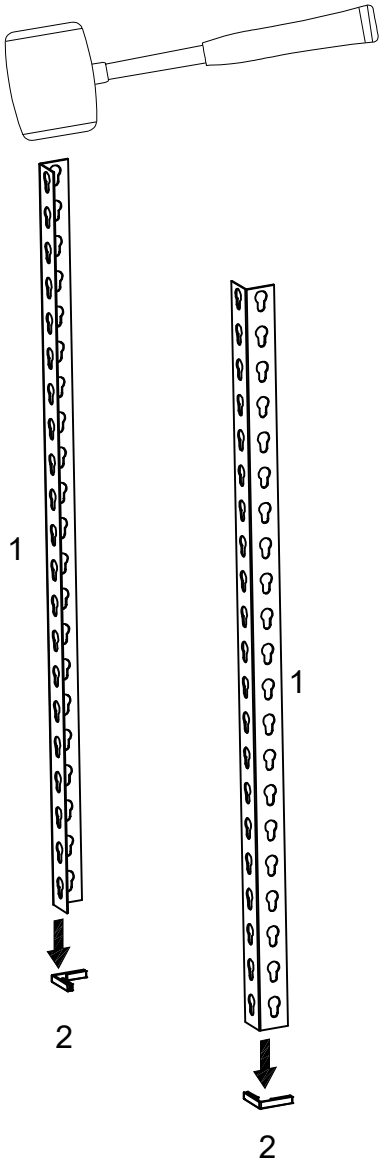

Step 2

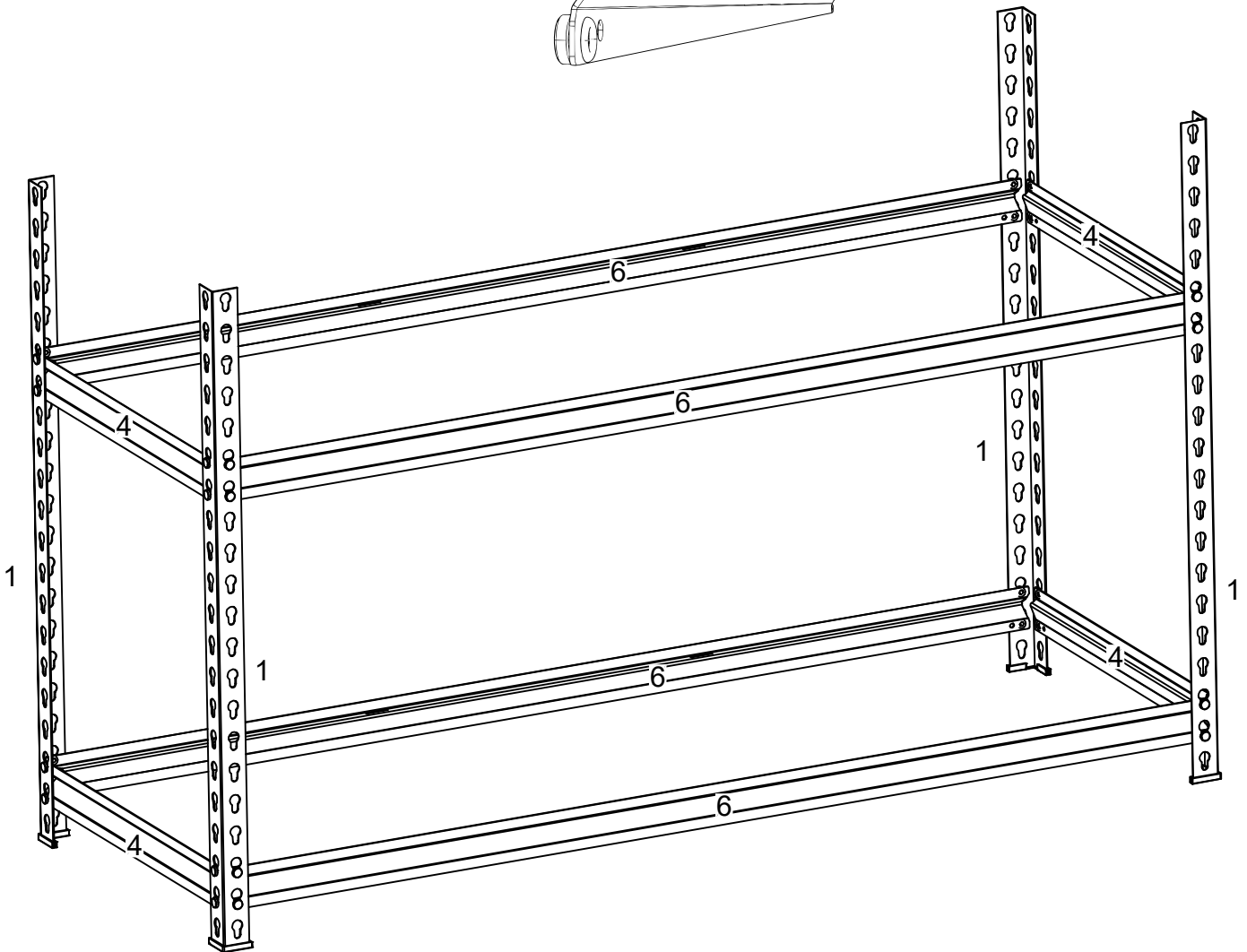
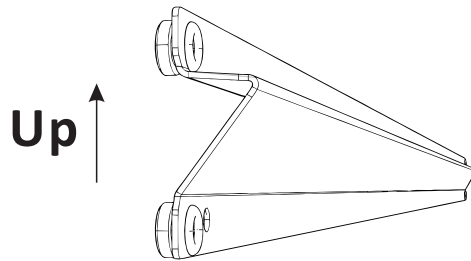
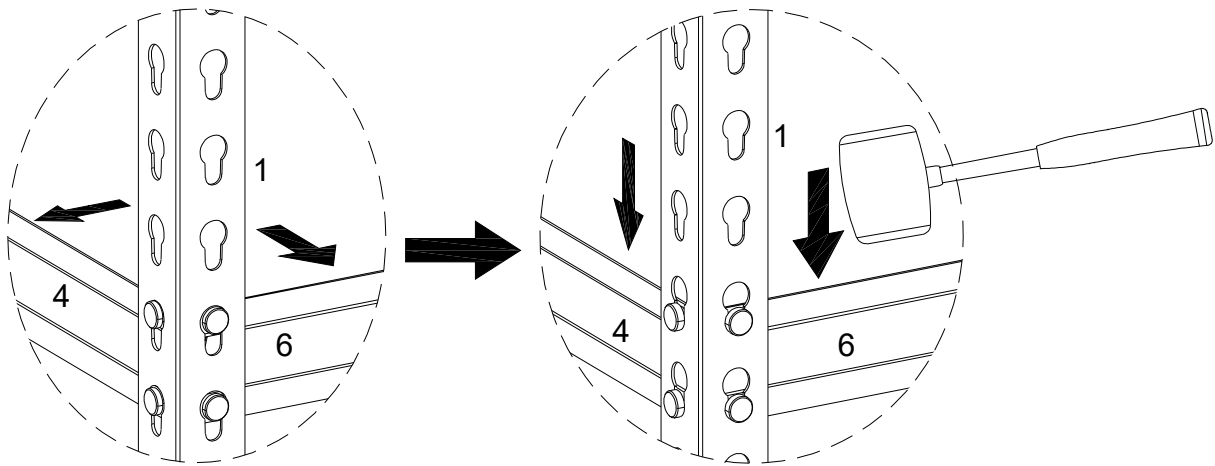

Step 3

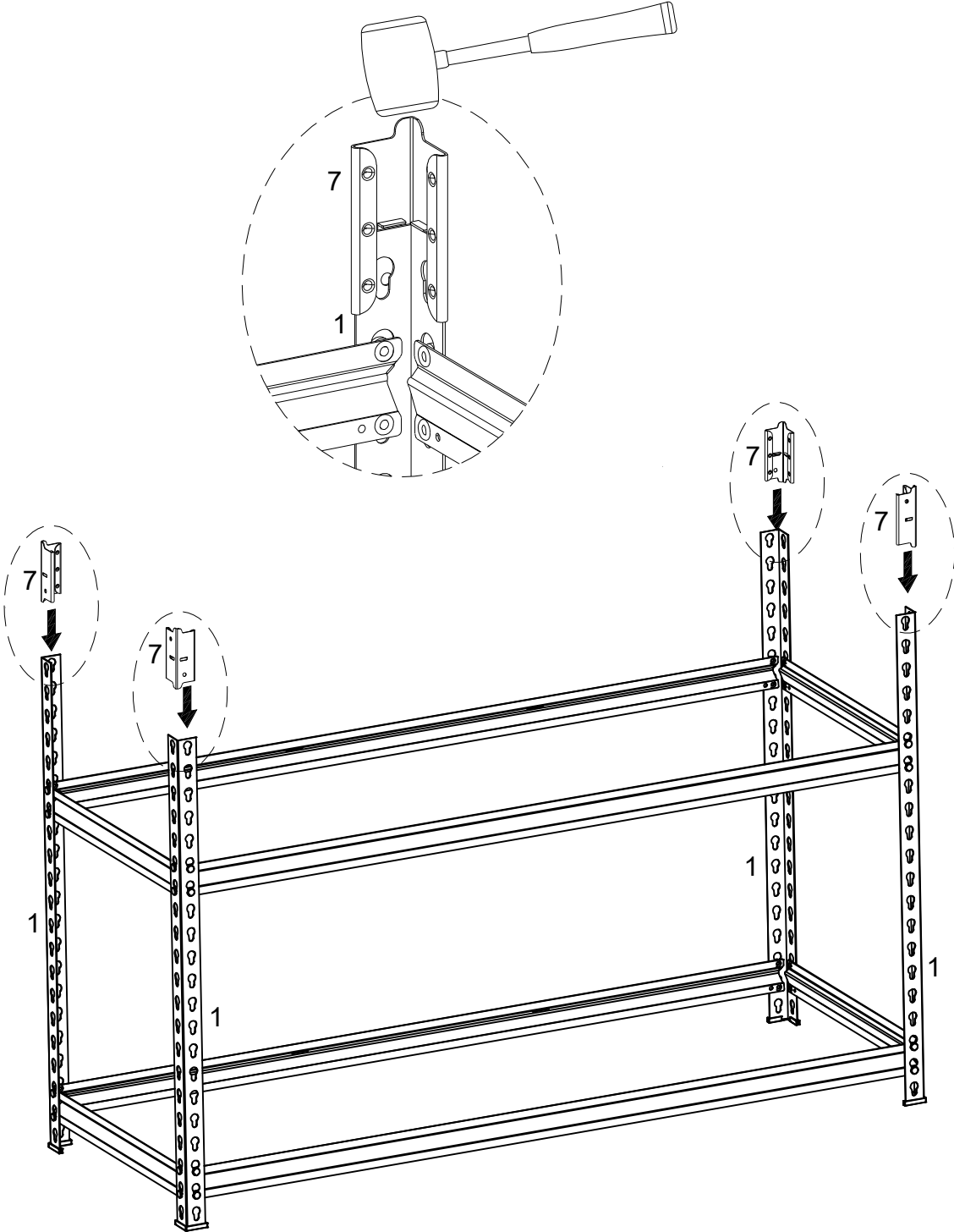

Step 4

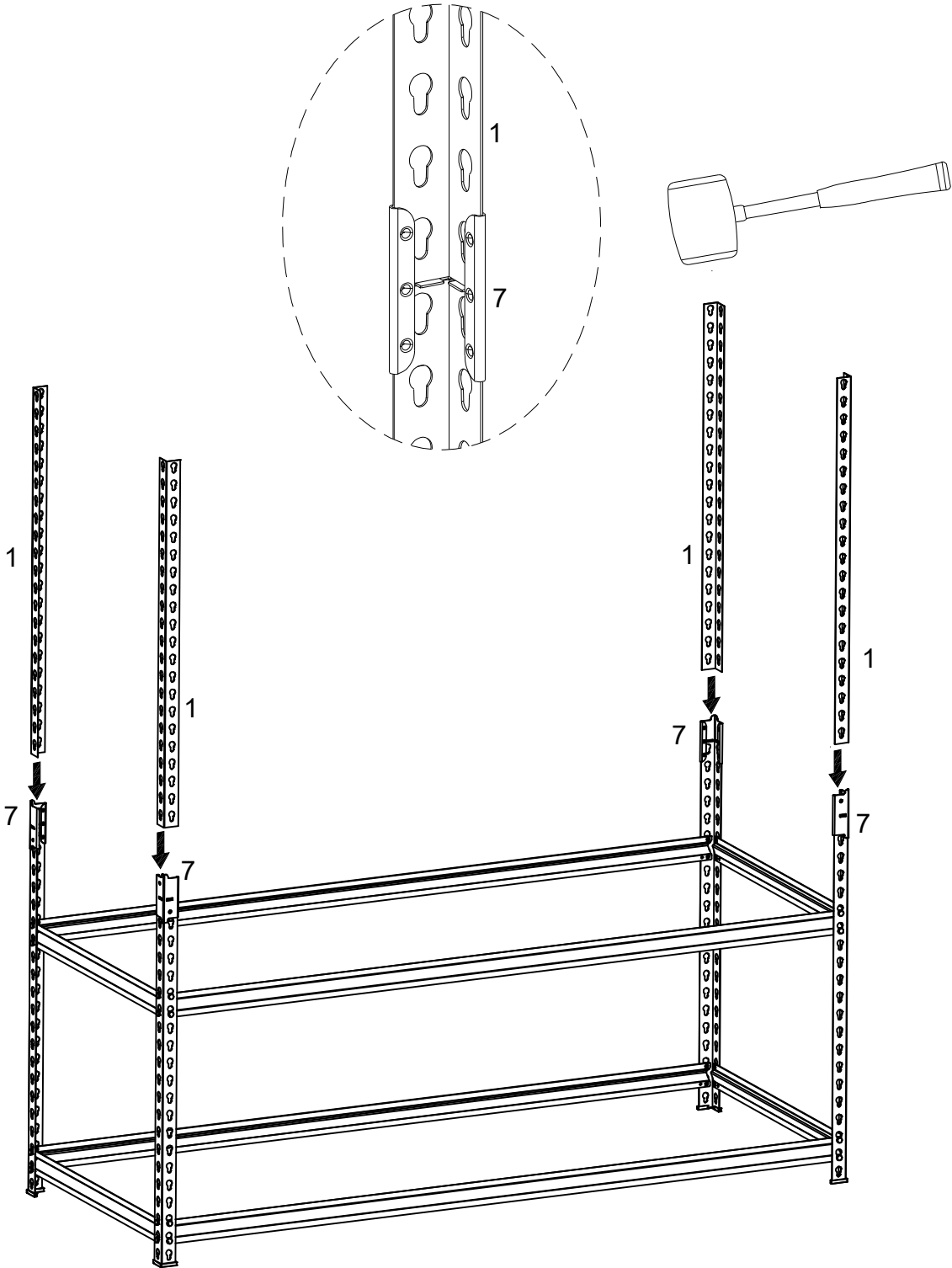

Step 5

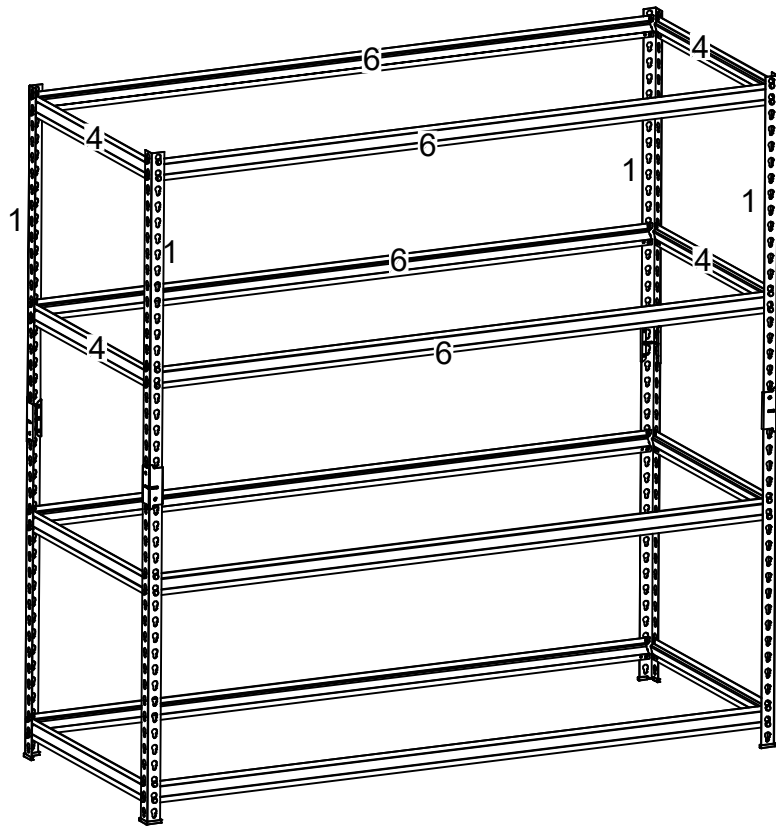
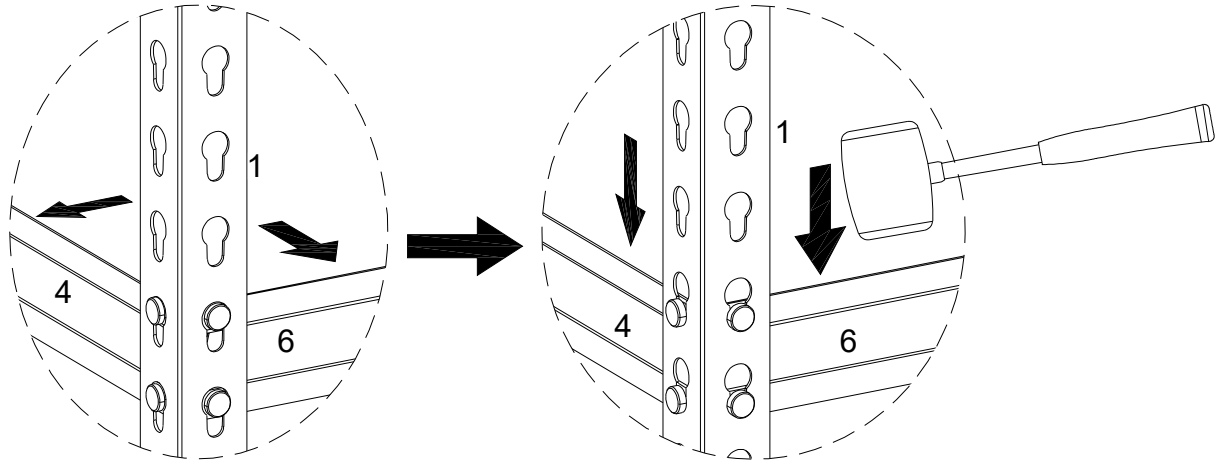

Step 6

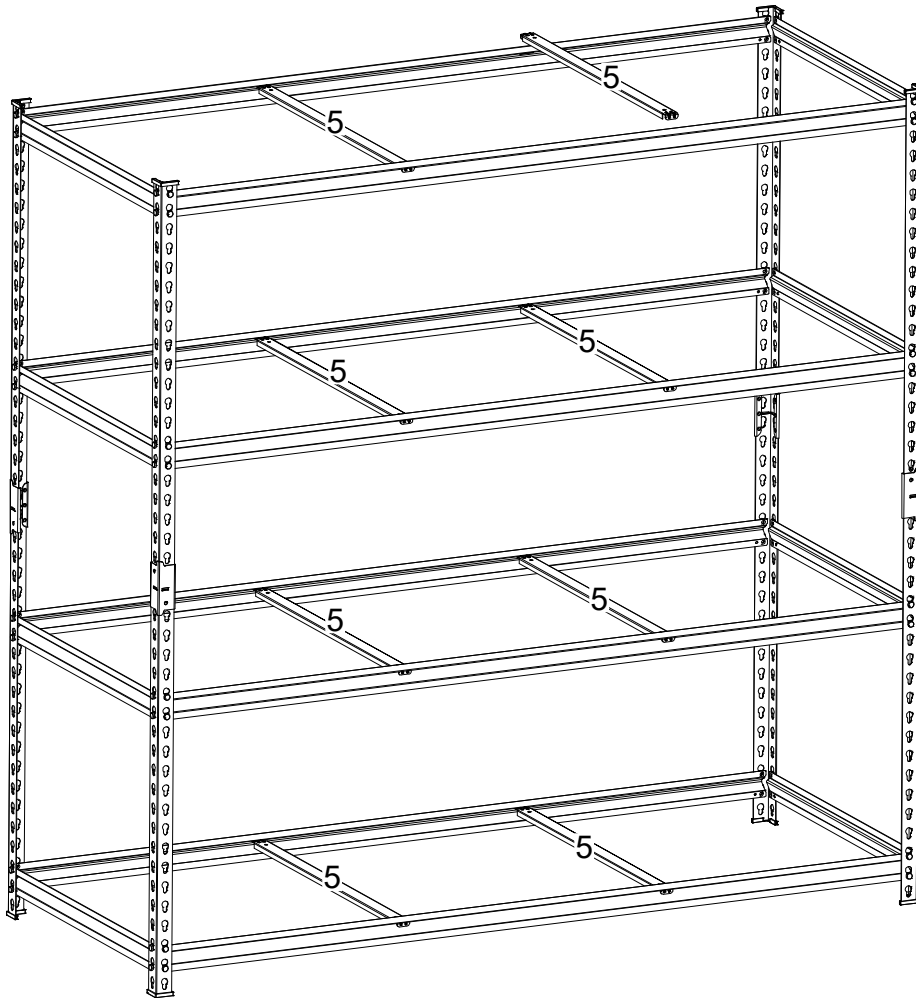
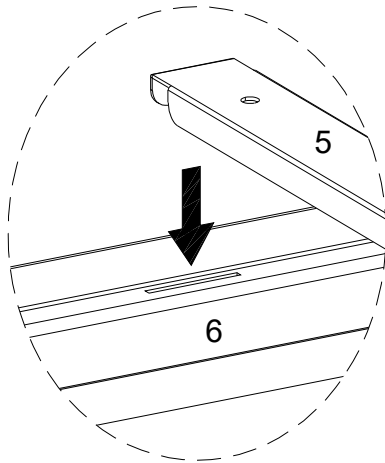

Step 7

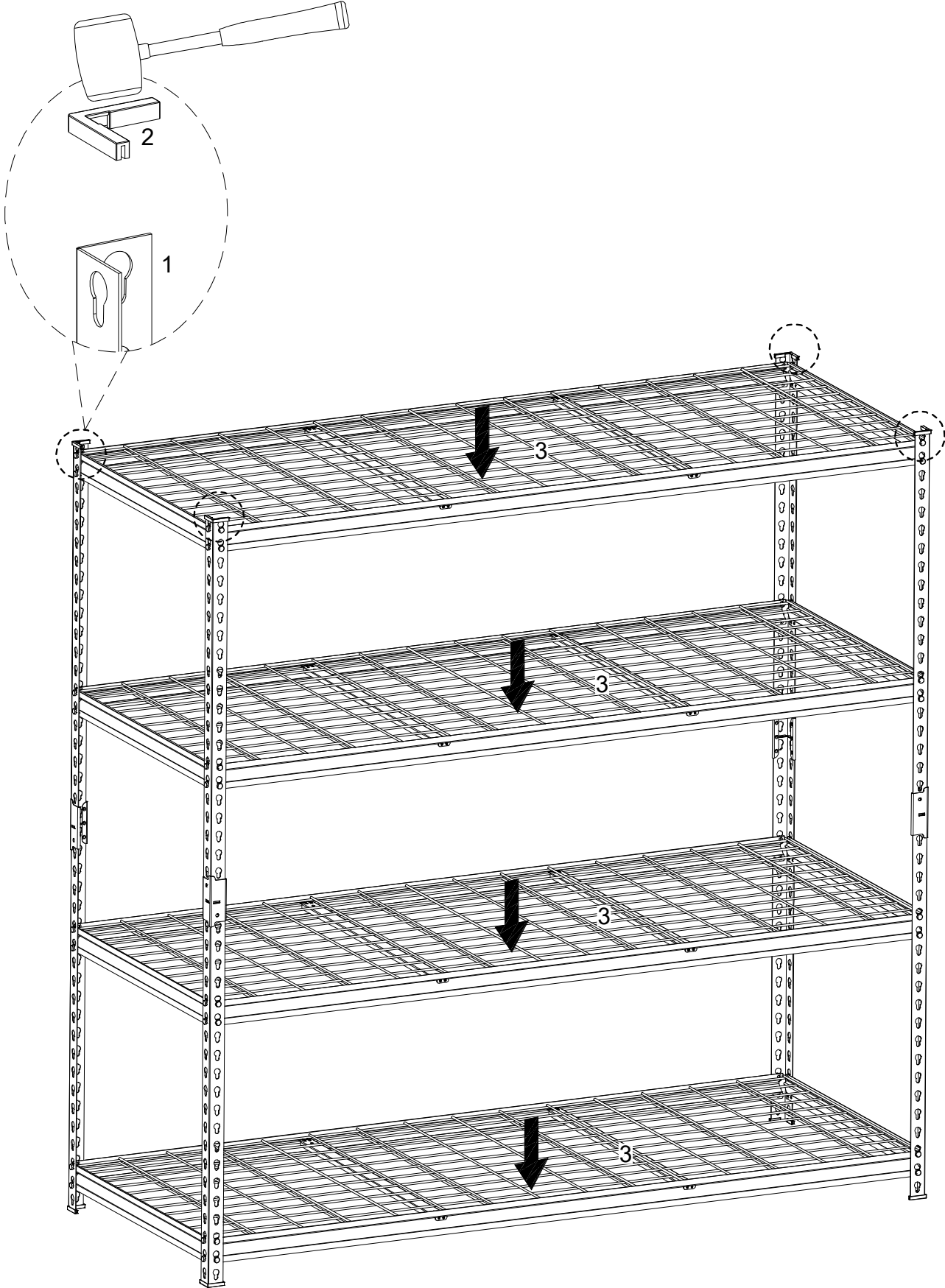

Step 8

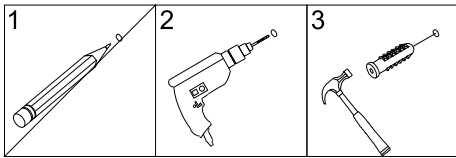

WARNING: Serious or fatal injuries can occur from furniture tipping over. To prevent the furniture from tipping over we recommend that it is permanently fixed to the wall. Wall anchor and hardware are included with this product. Please make sure hardware is suitable for your walls before installing, as different wall materials may require different types of anchors.

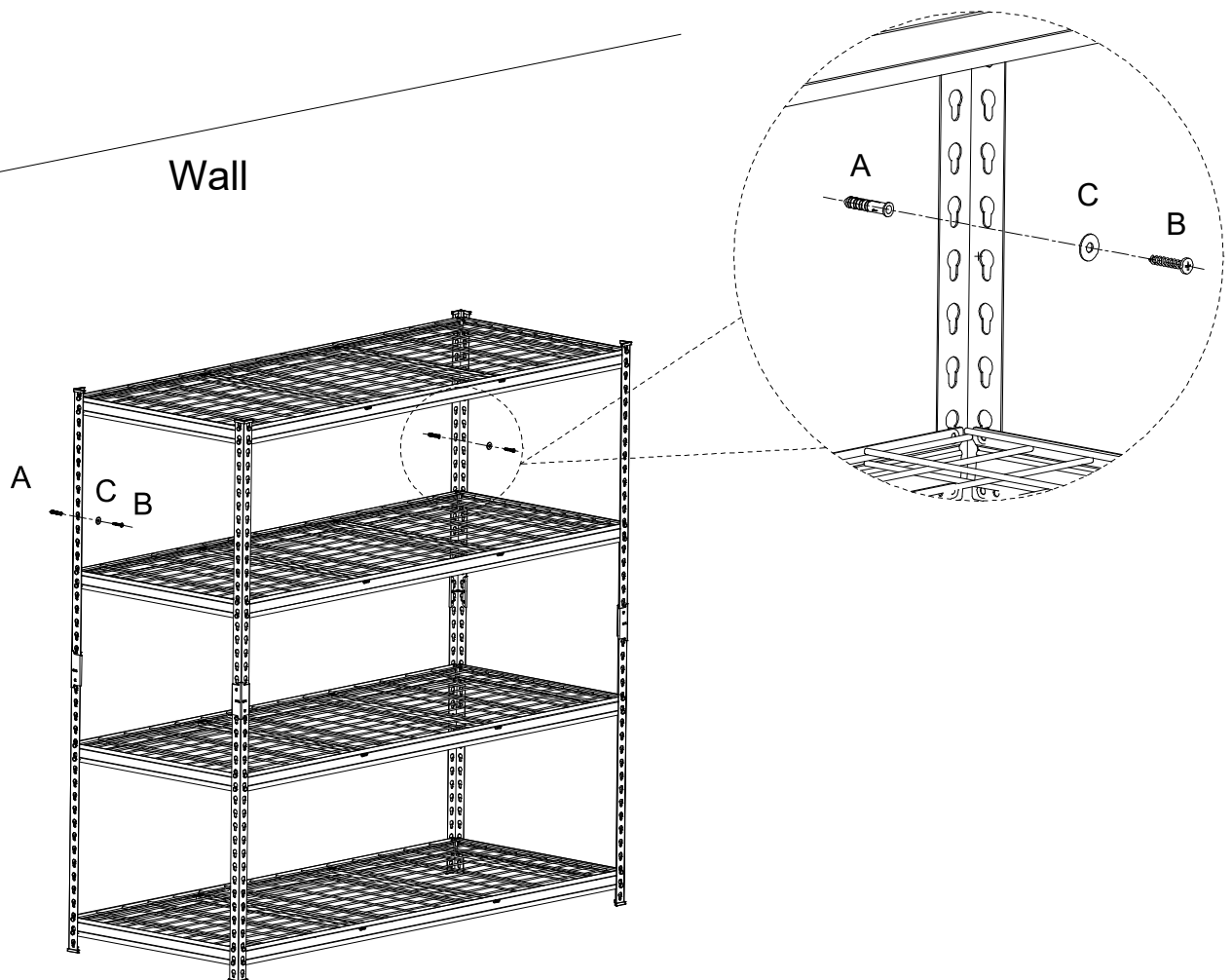

AFTER-SALES SERVICE CARD

We sincerely thank you for trusting our service and our products, and may this product add enrichment to your home. We guarantee that the product has undergone strict quality inspection and meticulous packaging. If you encounter any issue regarding either shipping or the product, please feel free to contact us at any time. We'd be more than happy to serve you wholeheartedly.

Yours Sincerely

- Please avoid harsh, corrosive and abrasive cleaners
- Keep dry and avoid damp environments

Customer Support

Phone: +1(986)-888-1726

Email: help@unified-support.com

Hours: Mon-Fri, 9:00 AM - 6:00 PM ET

If you have any questions or concerns please feel free to contact us. We're committed to providing our customers with the quality service.