

Product Installation Instructions

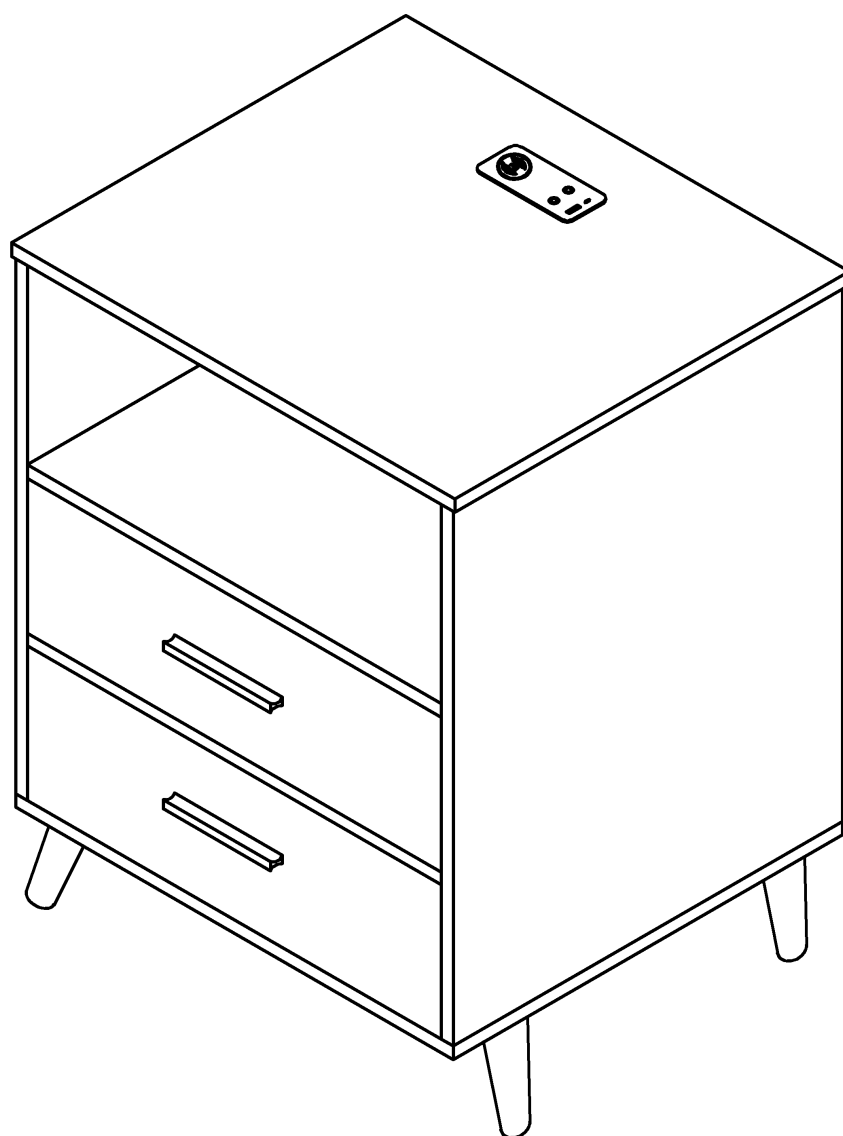

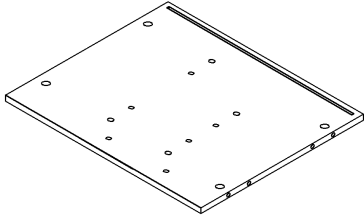

Ax1

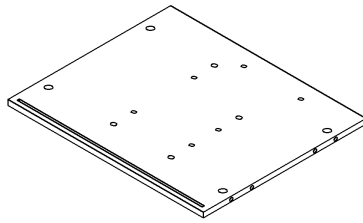

A2x1

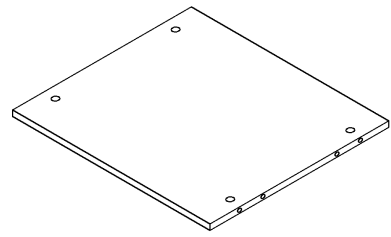

Bx1

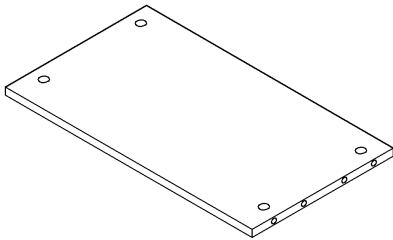

Cx1

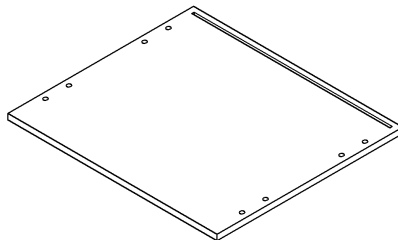

Dx1

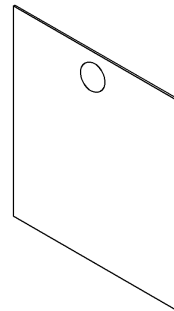

Ex1

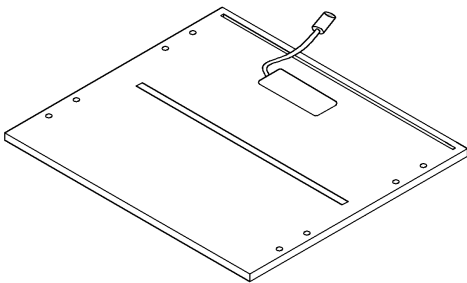

Fx1

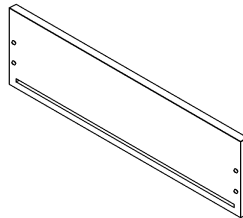

Gx2

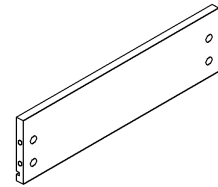

Hx4

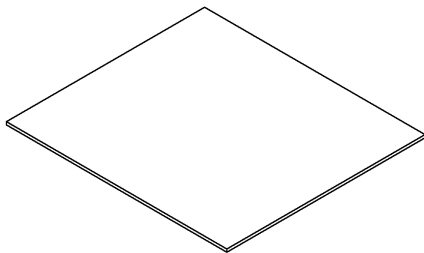



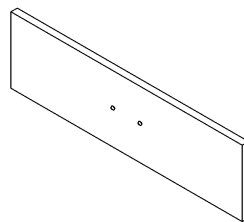

Ix2

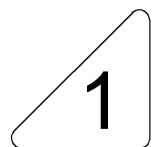

Jx2

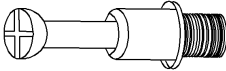

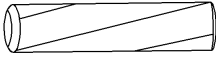
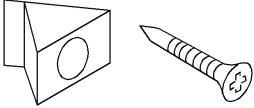
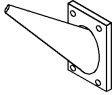
1

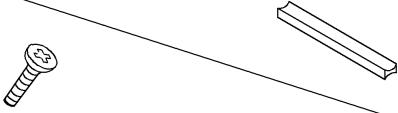
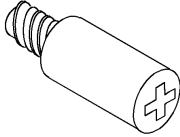
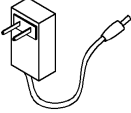
①		Two In One Screw (6x28mm)	32pcs +4pcs
②		Two In One Nut (10x12mm)	32pcs +4pcs
③		Wood Chipping (6x30mm)	16pcs +2pcs
④		Back Plate Buckle & Screw (3x16mm)	4pcs
⑤		Taper foot	4pcs
⑥		Screw (4x12mm)	16pcs +2pcs
⑦		Screw & Handle (4x16mm)	2pcs 4pcs +1pcs
⑧		Iron Pin Screw	4pcs +1pcs
		AC/DC Adapter (12V=3.0A)	1pcs

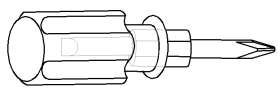

1pcs

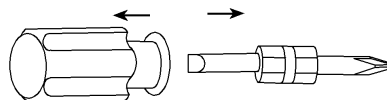



Double-head screwdriver, use as required

2

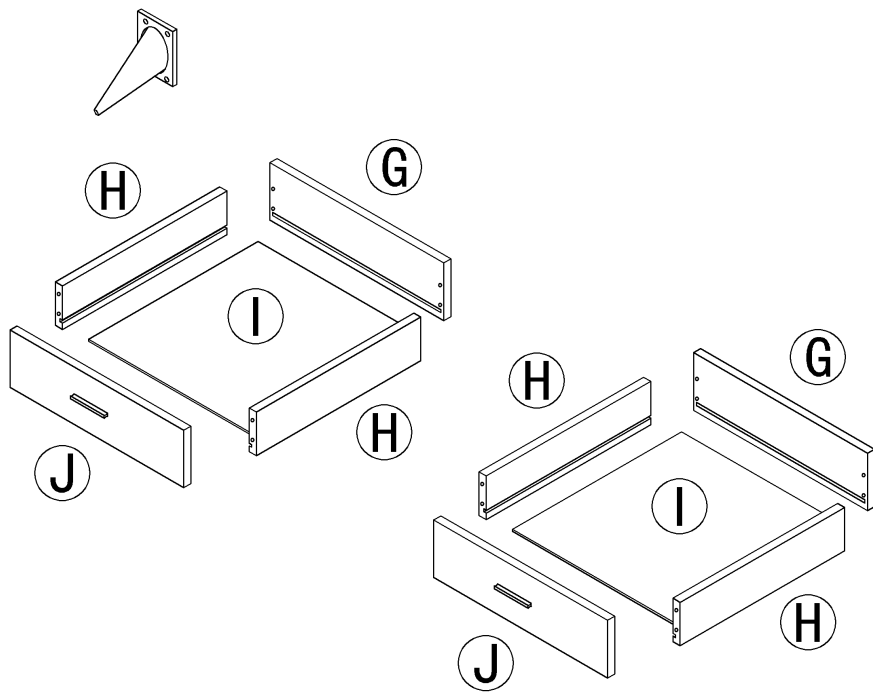
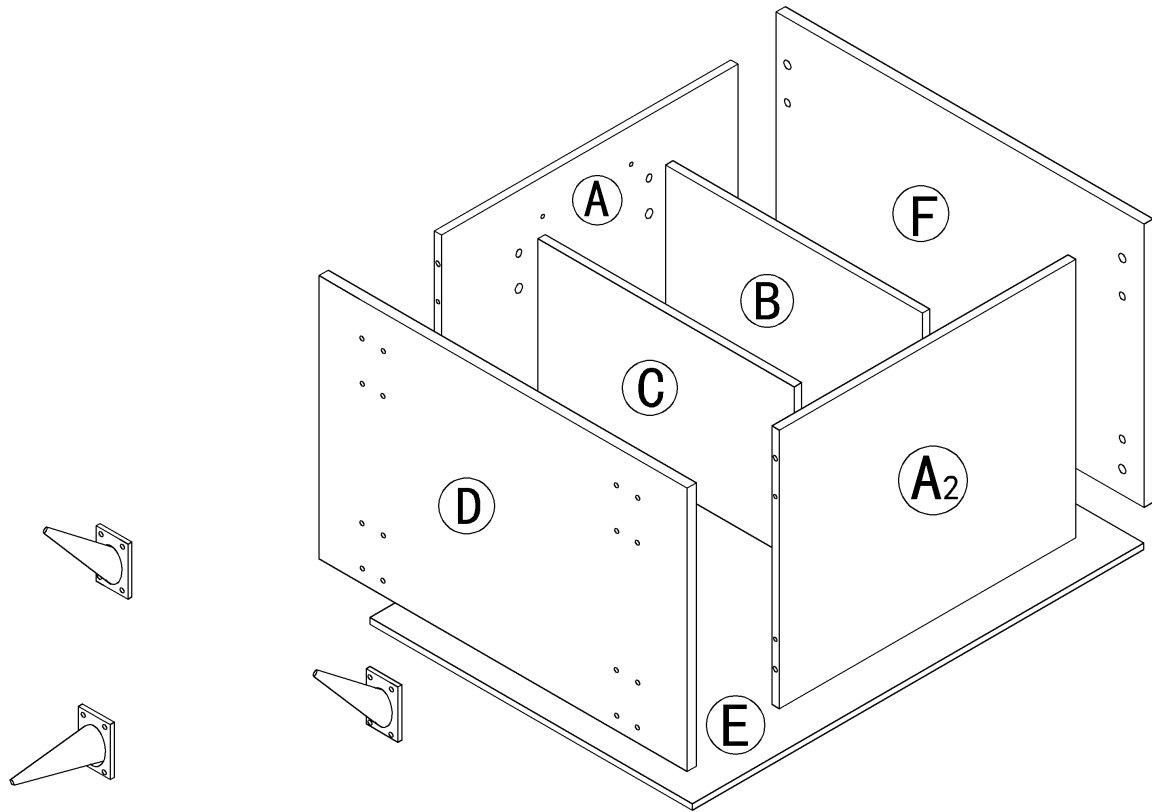
Product structure decomposition

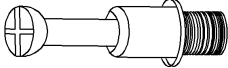
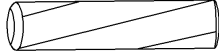

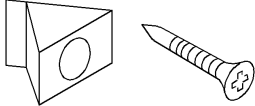
1		16pcs	3		16pcs
2		16pcs	4		4pcs

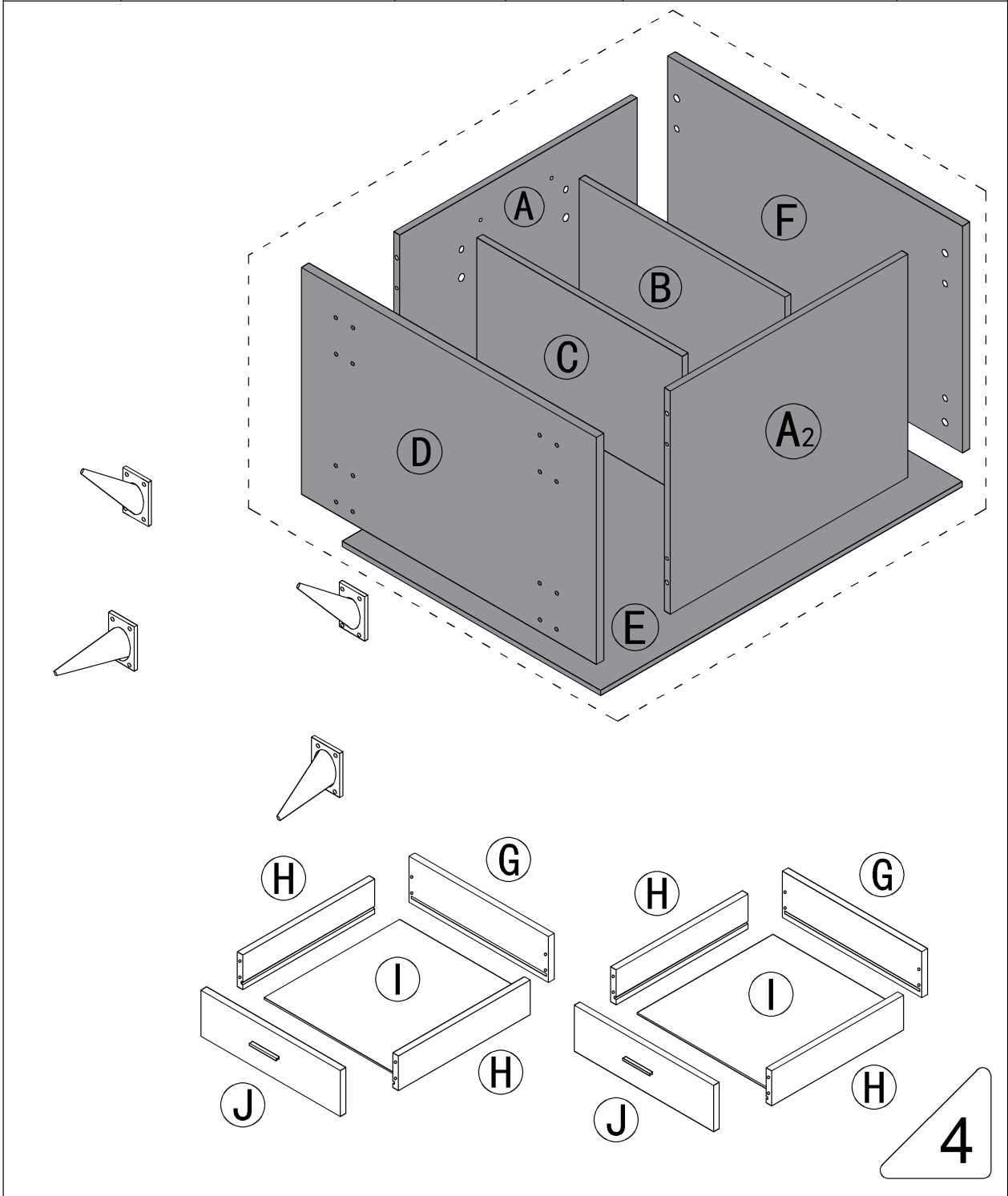

Use parts ① and ②

Step1

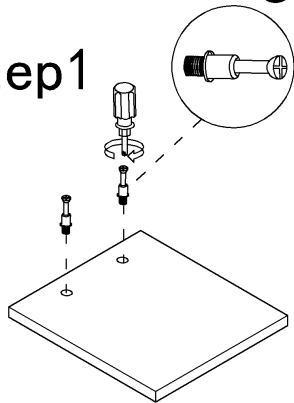

Step2

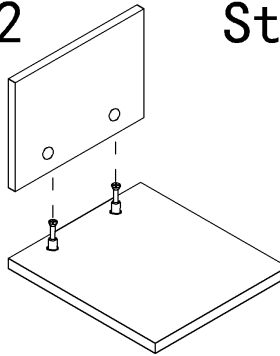

Step3

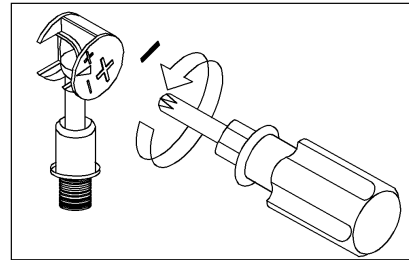
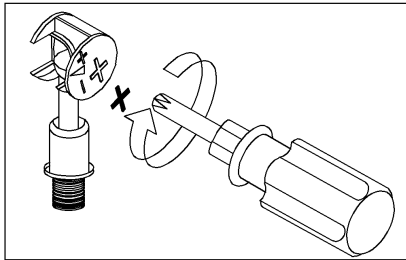
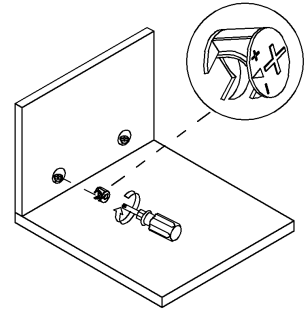

Use a screwdriver to lock in the direction of the "+" sign

Disassemble along the direction of "-" sign

Step 1

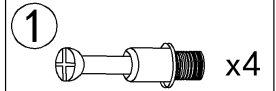
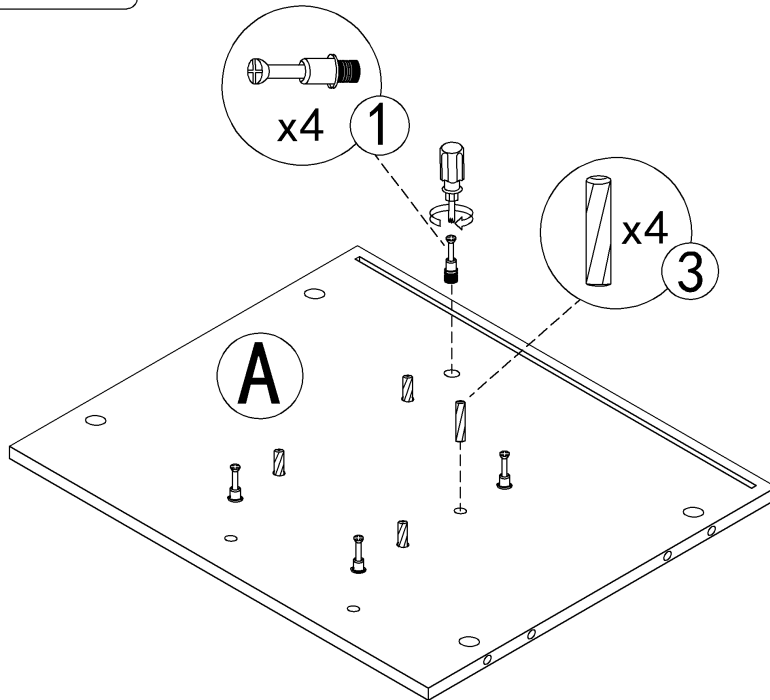

5

Step 2

2



x2

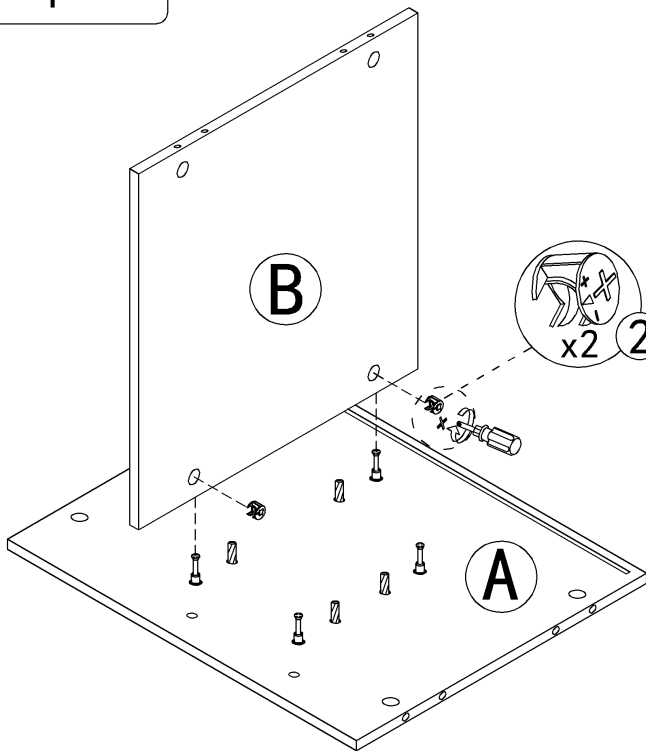

Step 3

2



x2

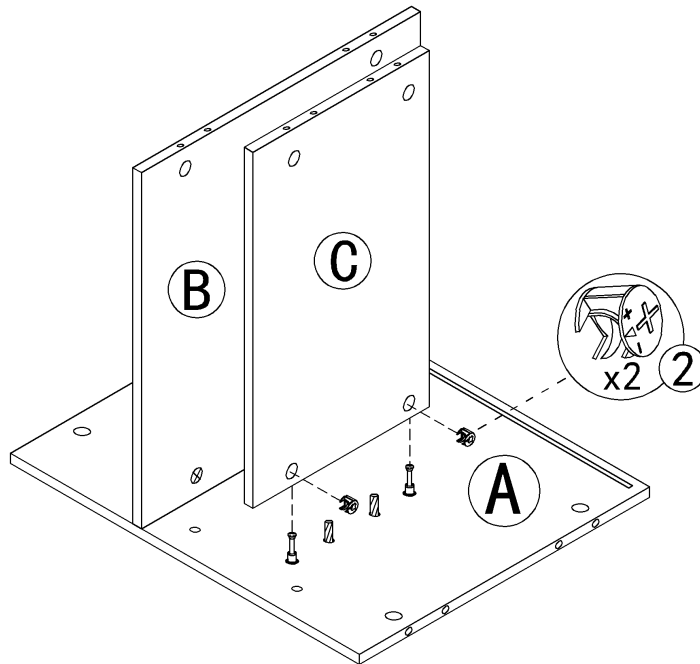

Step 4

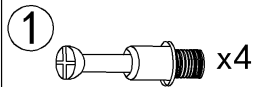
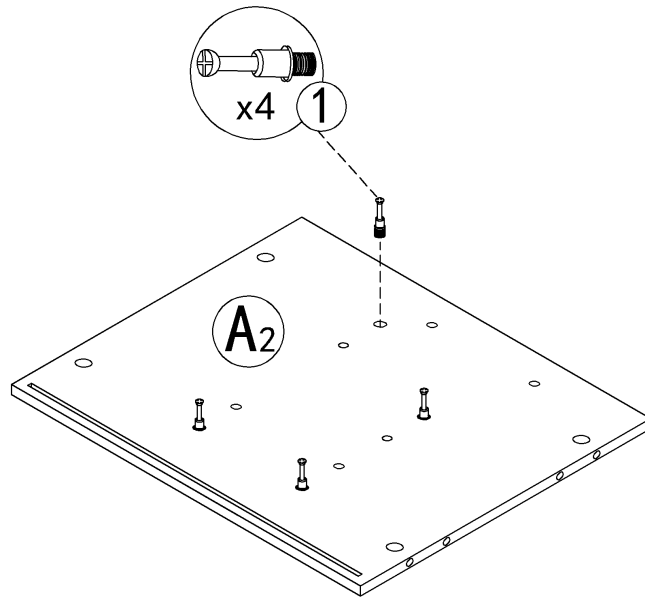

Step 5

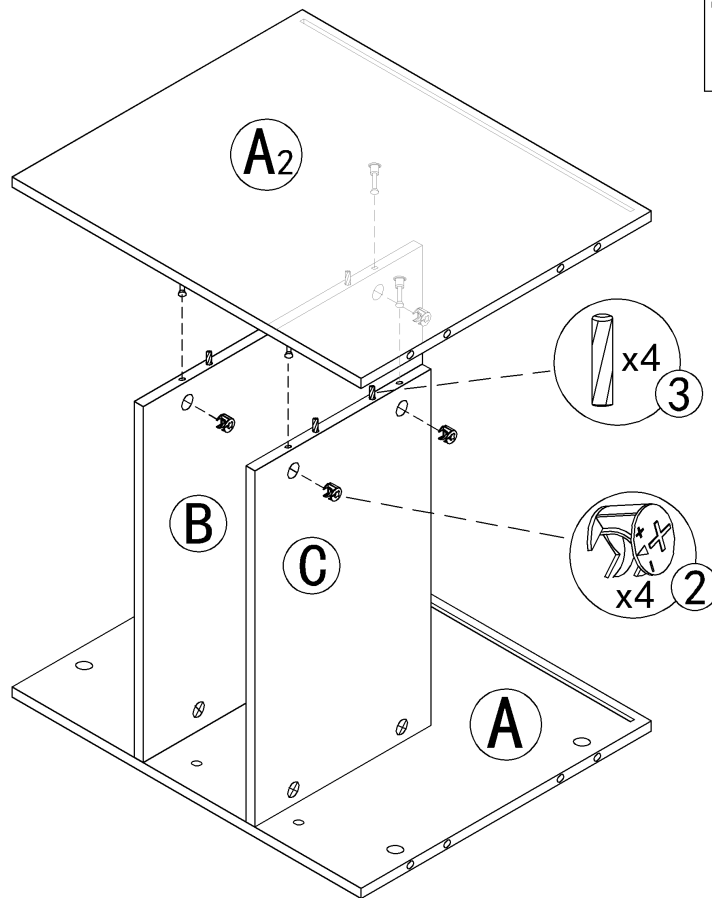

Step 6

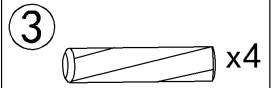
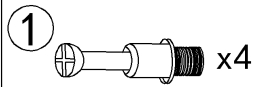
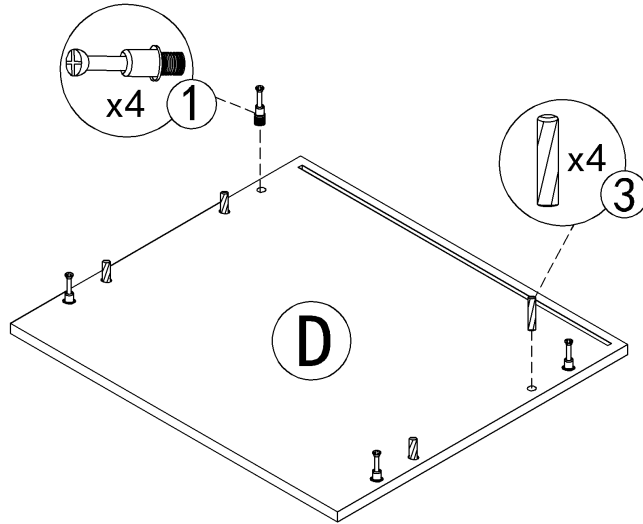

Step 7

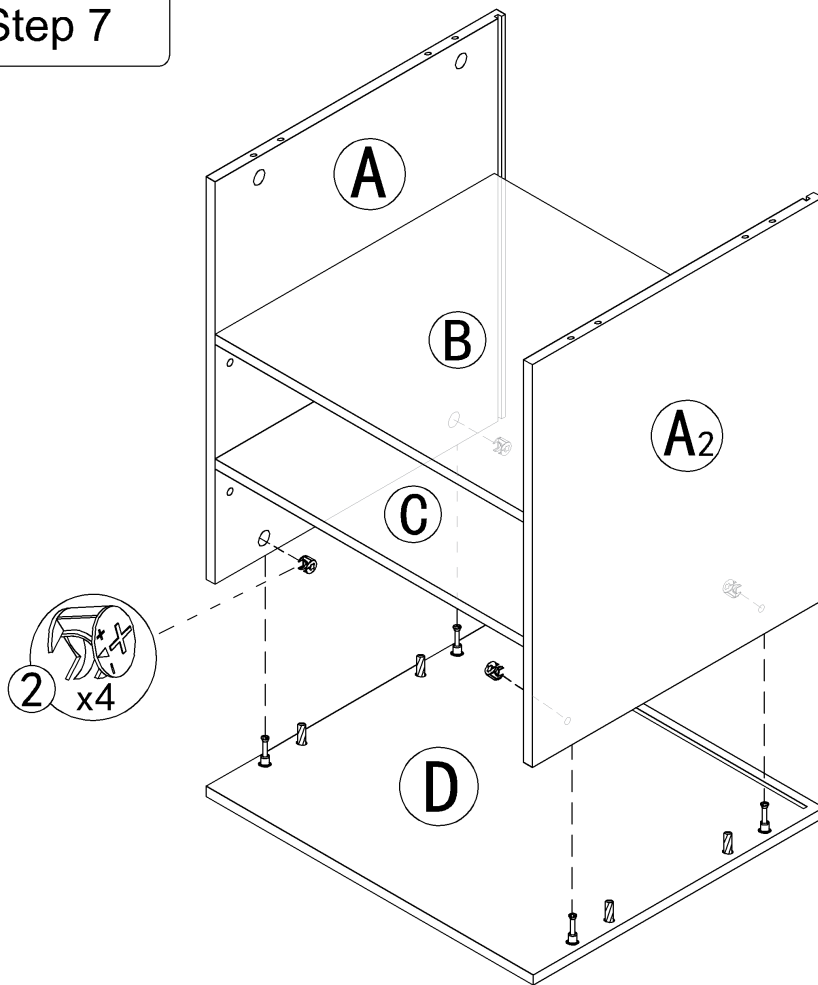

Step 8

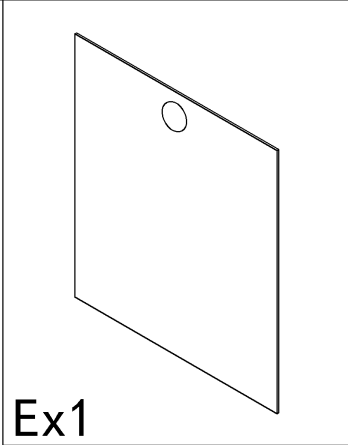
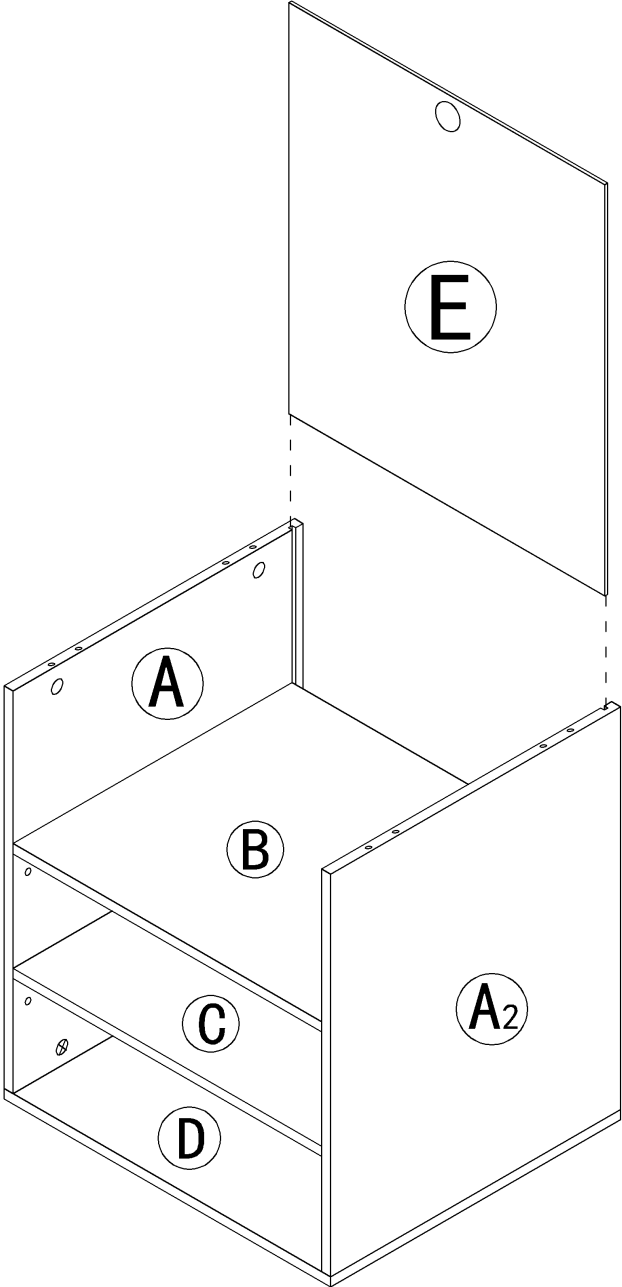

Step 9

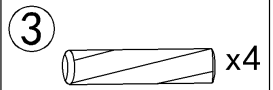
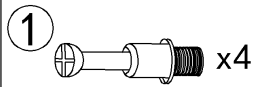
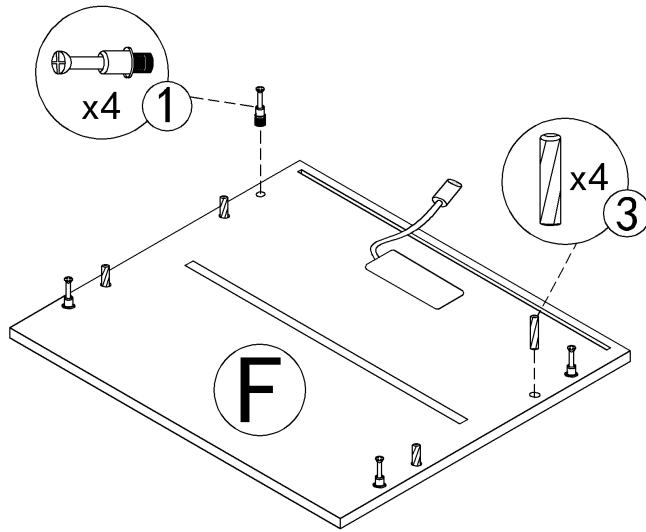

Step 10

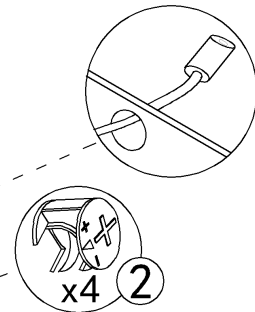
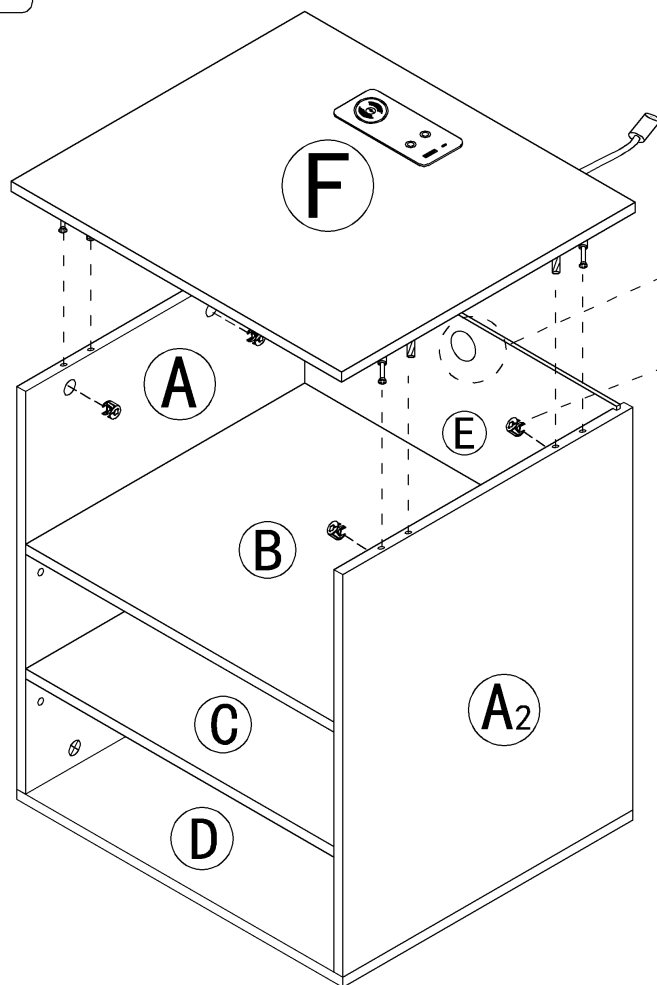

Step 11

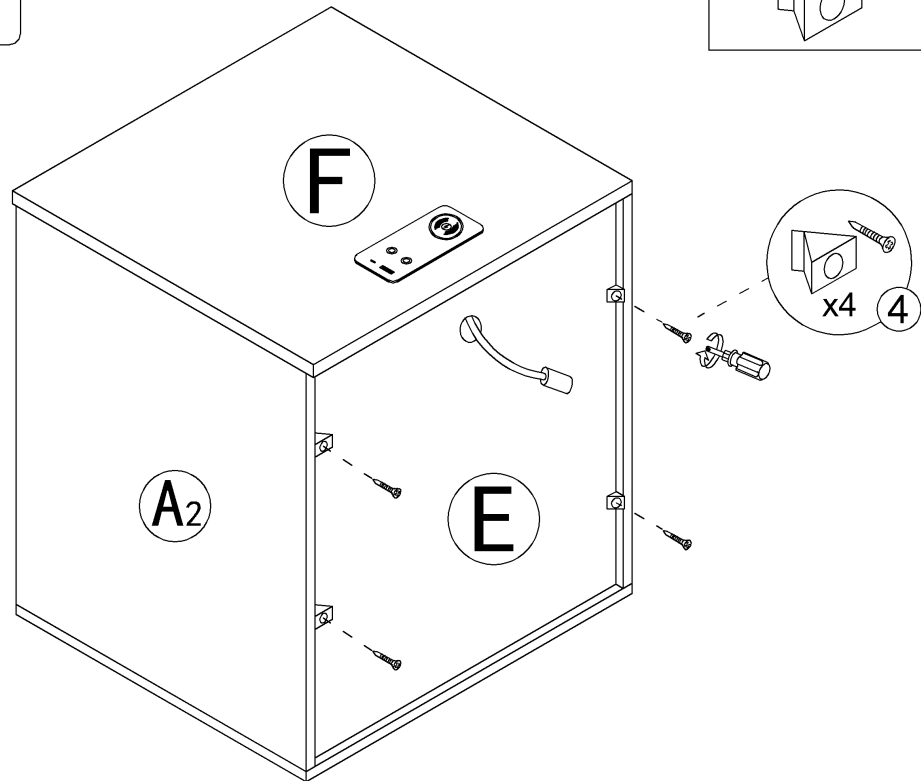
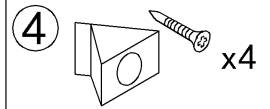

Installation completion drawing

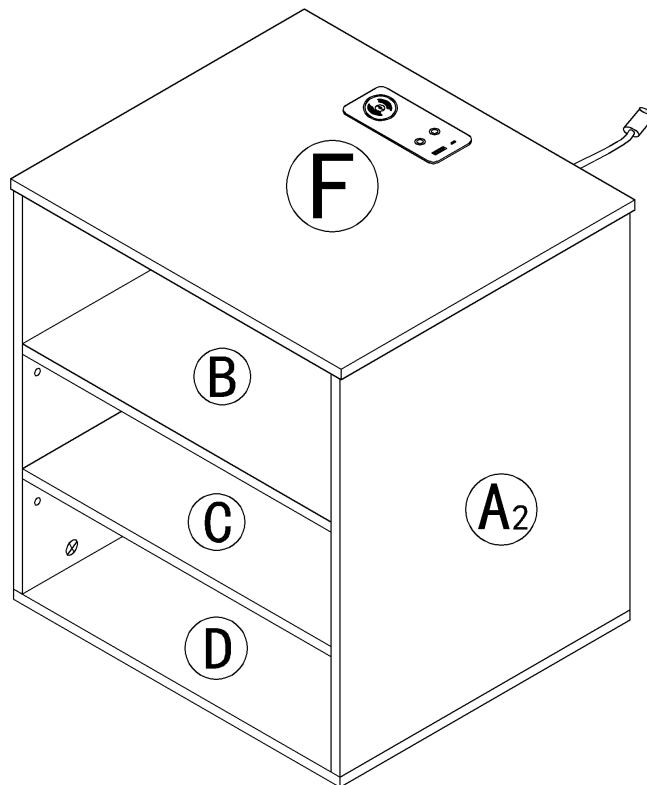

5

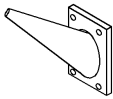

4pcs

6



16pcs

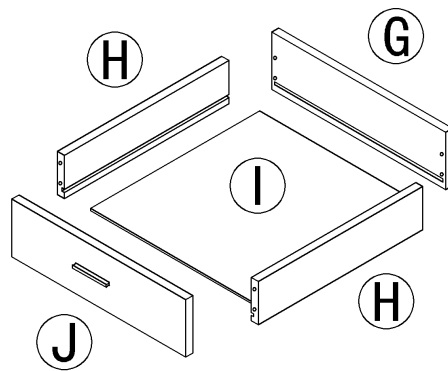
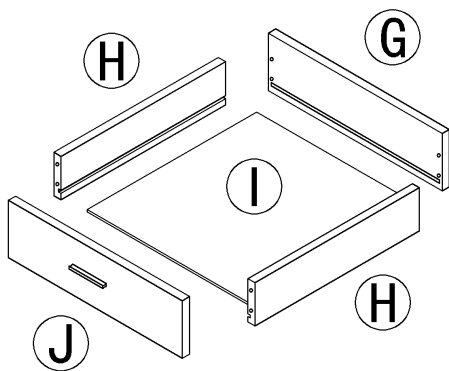
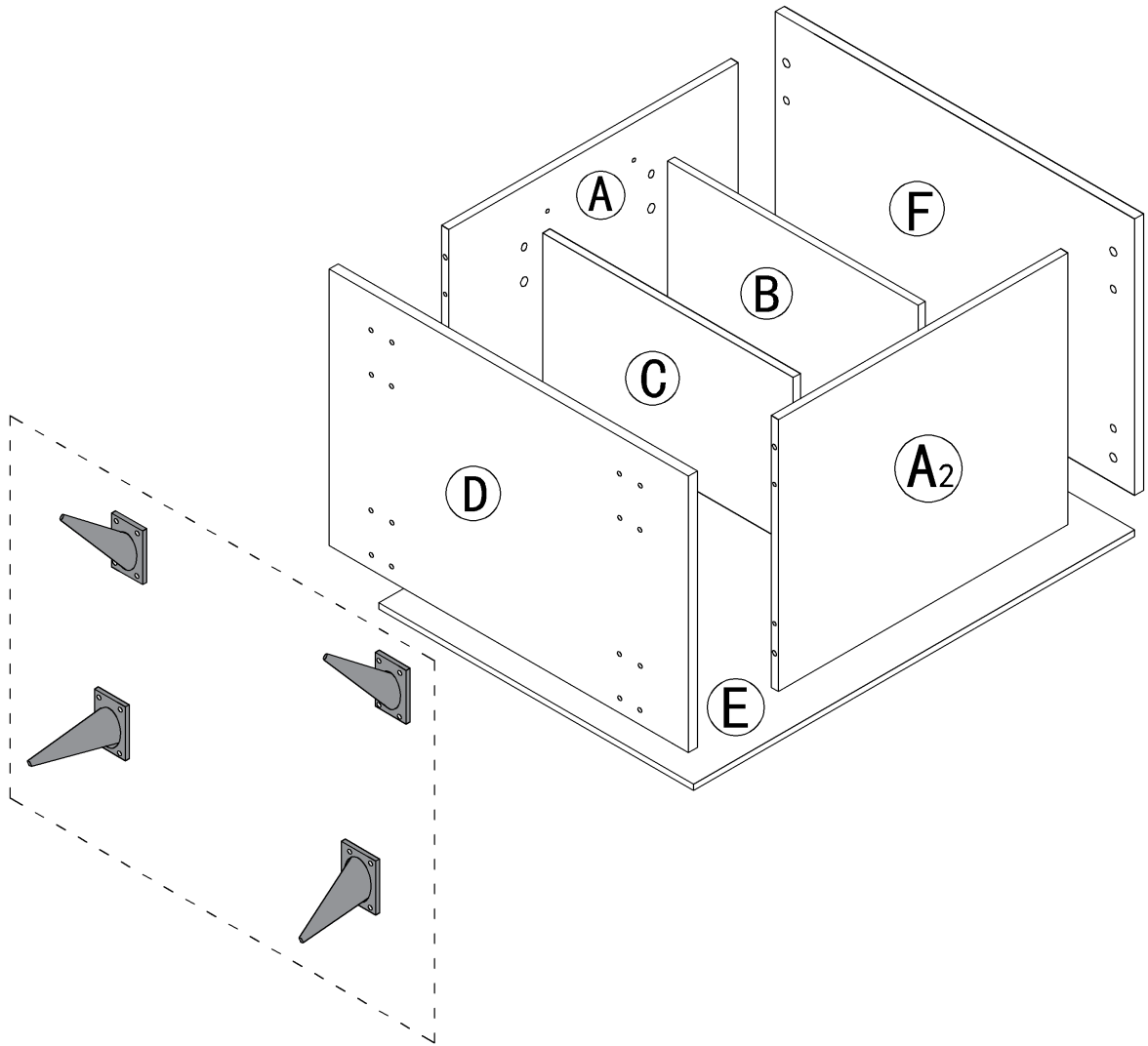

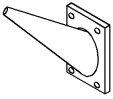

12

Step 12

5  x4

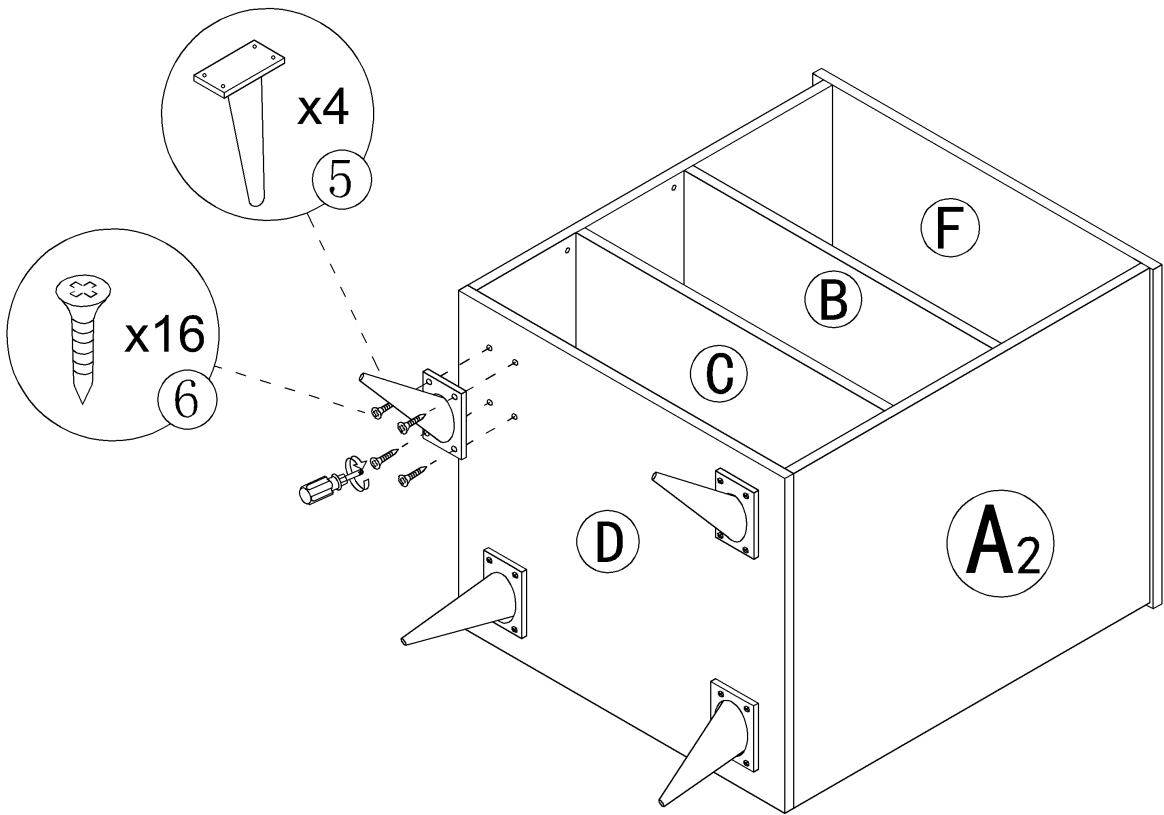
6  x16

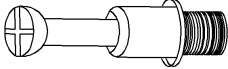
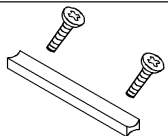

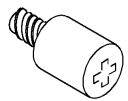
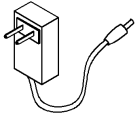
1		16pcs	7		2pcs
2		16pcs	8		4pcs
		1pcs			

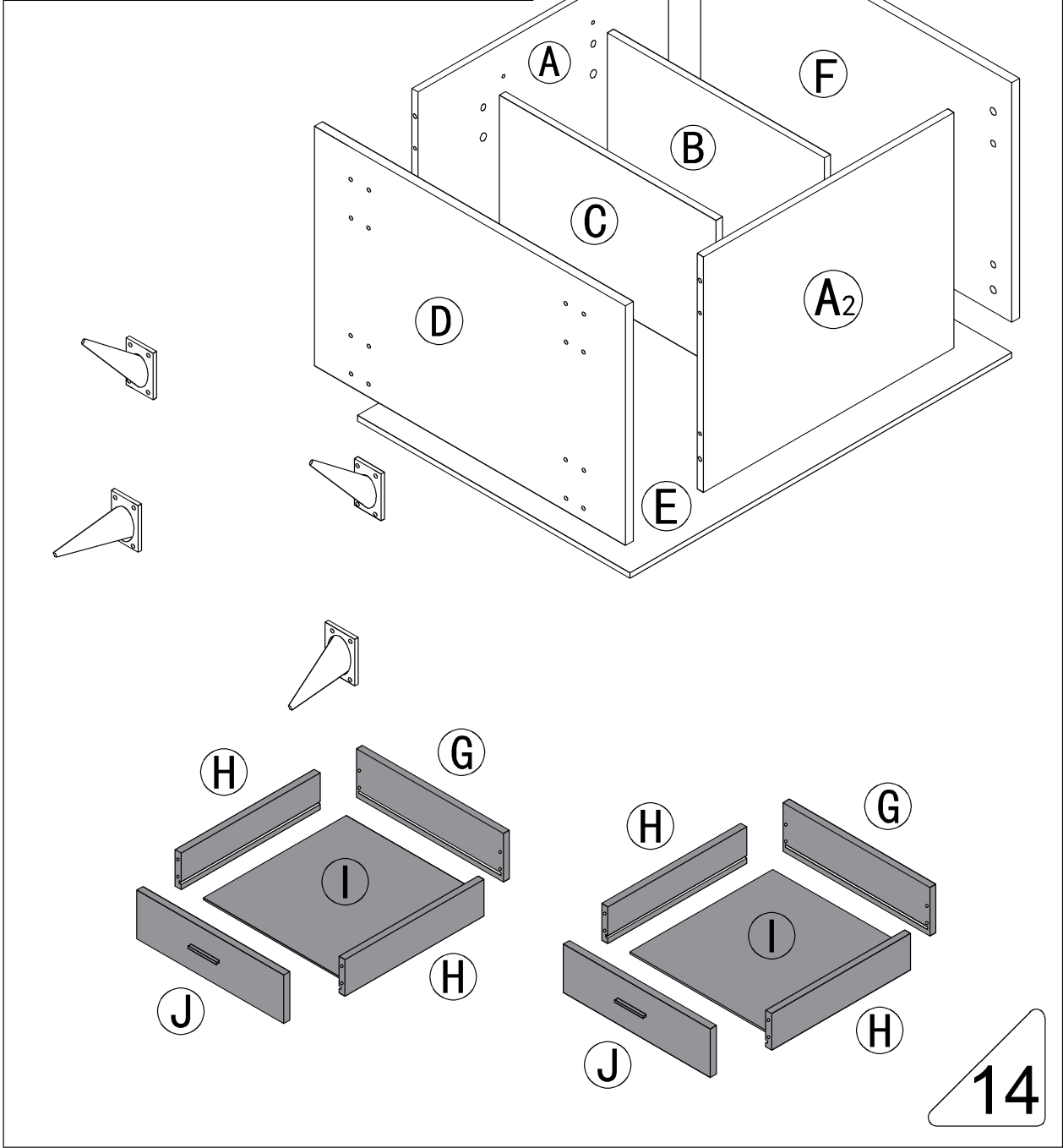

Step 13

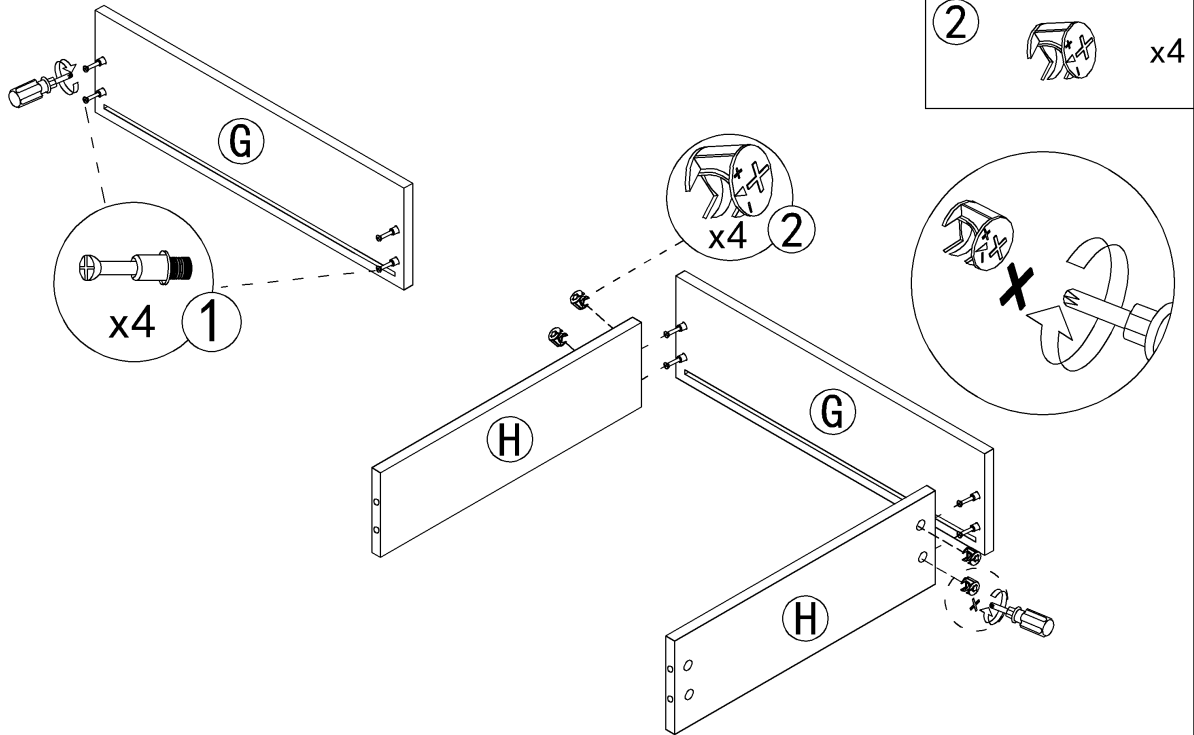

Step 14

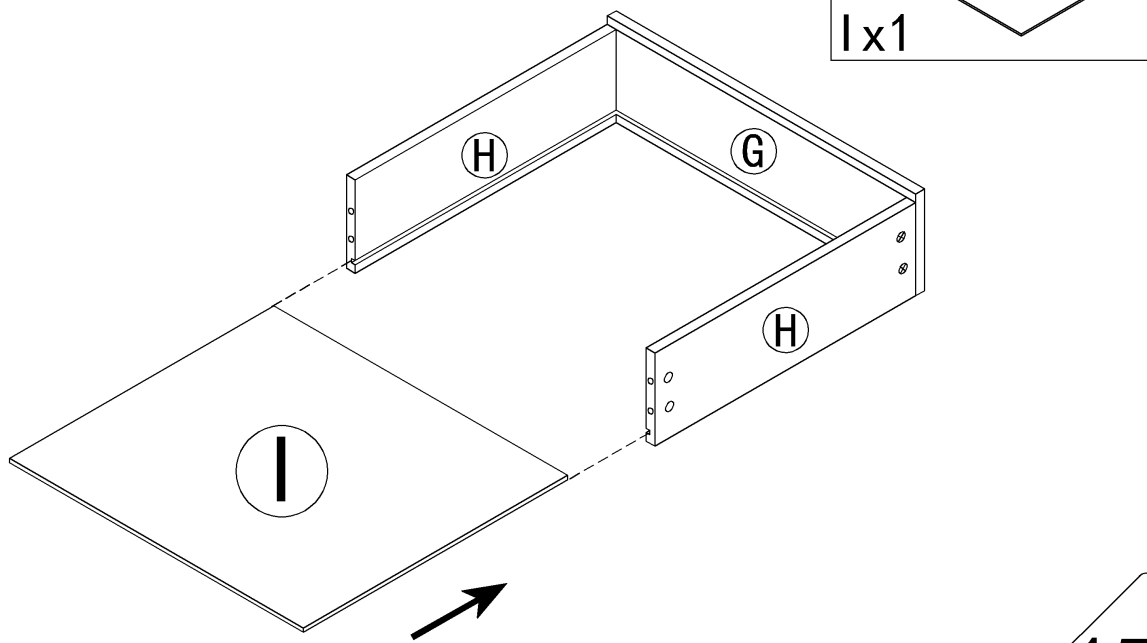

Step 15

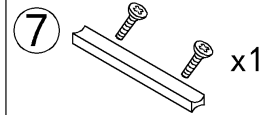
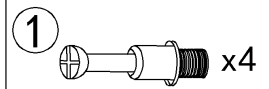
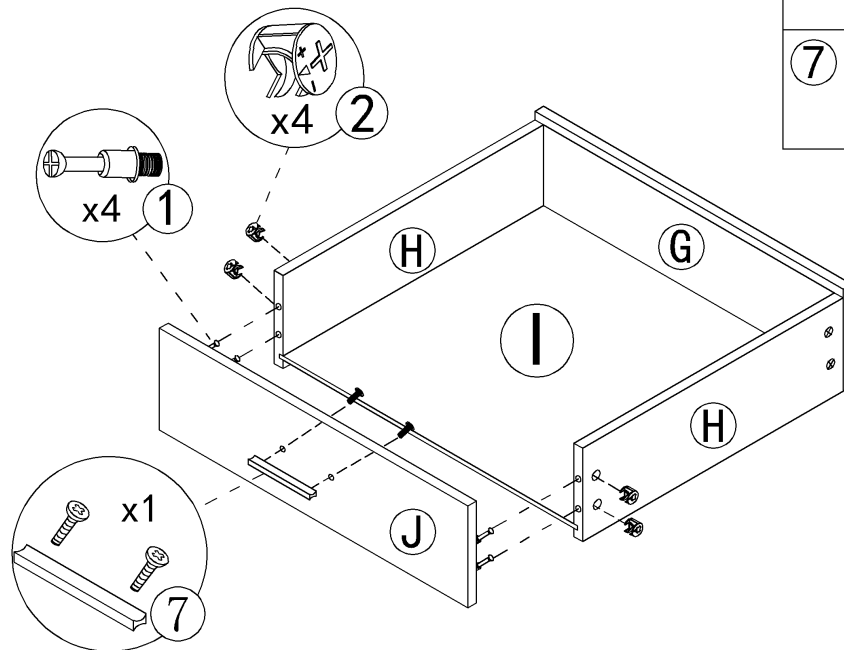

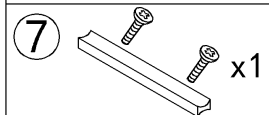
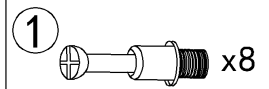
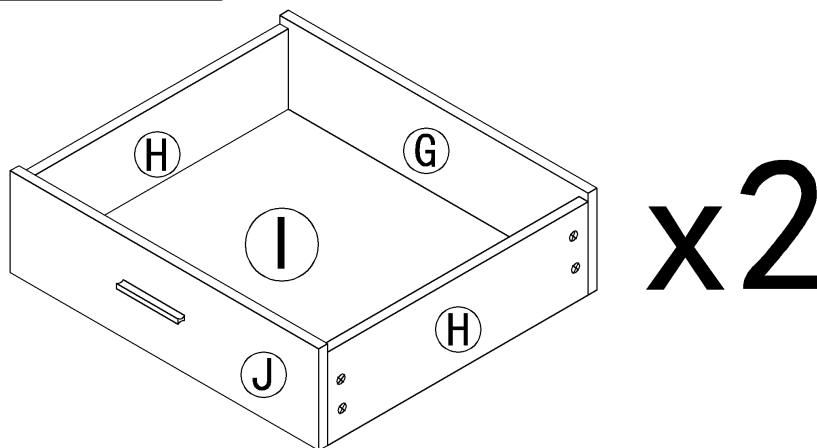

Step 16

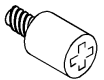

Use the same way to instalthe drawer

Step 17

8  x2

8  x2

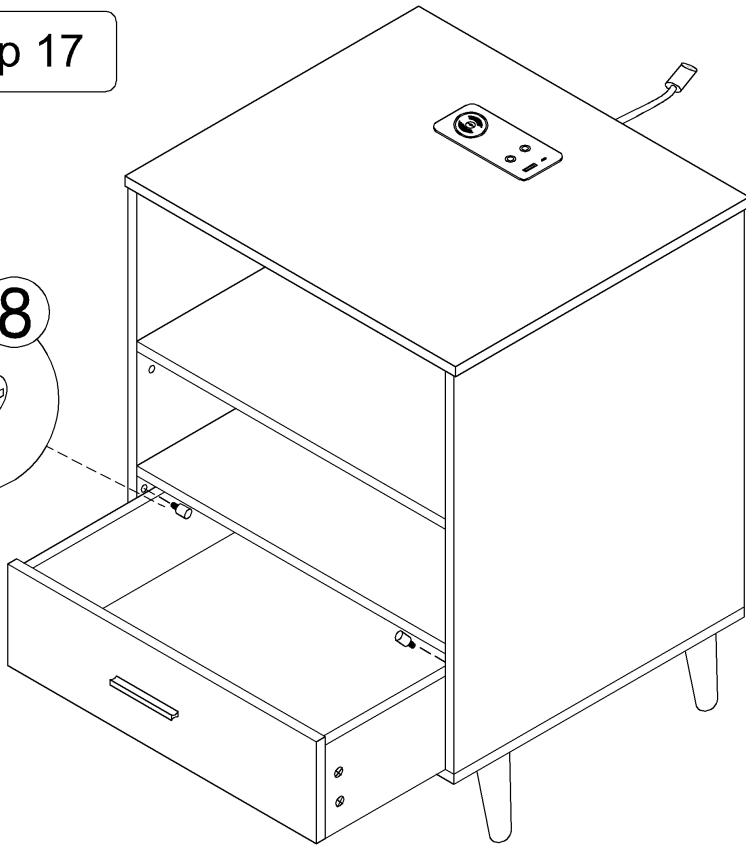

Step 18

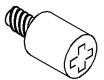
8  x2

8  x2

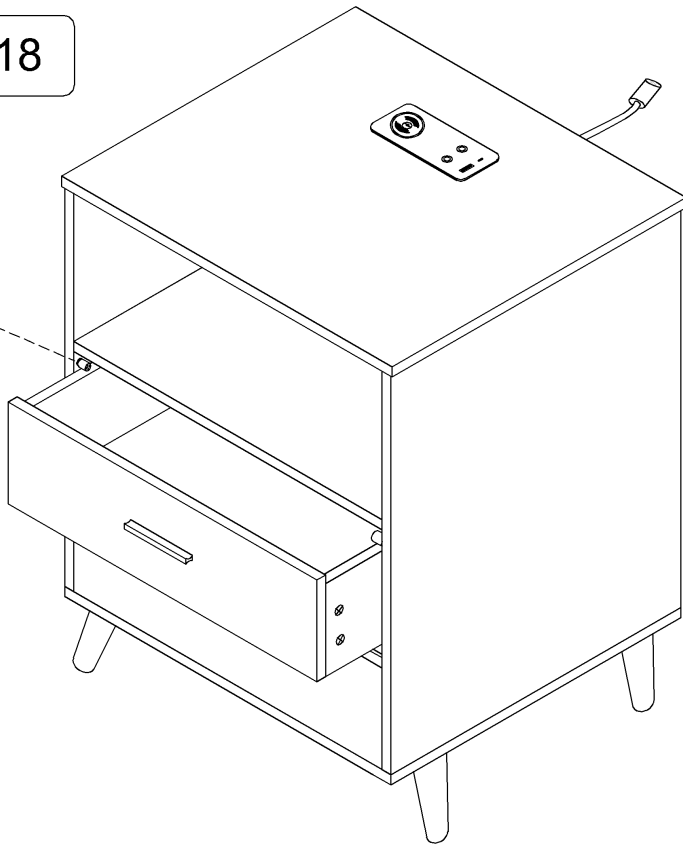

Step 19

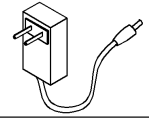

x1

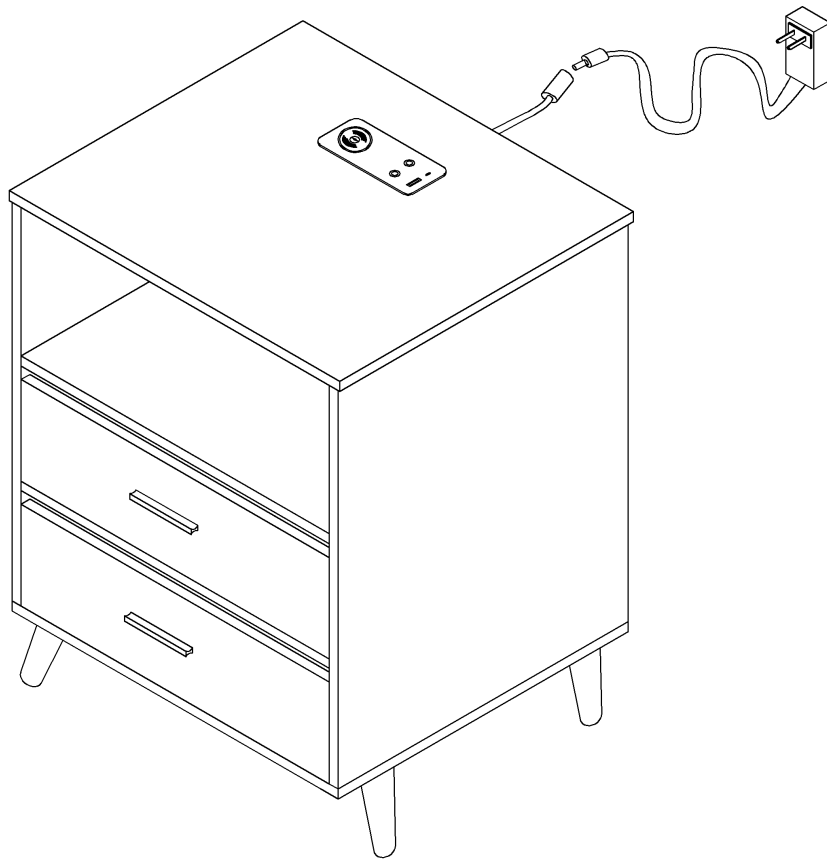



User's Guide

Thank you for purchasing this product.

To use this product, please plug it into a 12V DC power supply.

Please use if the product works normally after connecting to power.

Introduction

The box is an intelligent controller. It has 1 USB port and 1 type-C port and can distribute the current output up to 5V DC-2A. With 2 touch buttons, it can turn ON/OFF the light, change light colors, and adjust the light luminance.

Operation



This touch button is used to turn on/off, change colors, and adjust brightness.

- A. Short touch -> lighting on -> short touch -> change light color -> short touch -> change light color -> short touch -> lighting off.
- B. Long touch -> adjust the luminance.



This touch button is used to turn on/off the induction function.

- A. Short touch to turn on the induction function. It can auto-turn on the light when people are close to the controller in 1 meters. It can auto power off the light when the body is far away from the controller after 30 seconds.
- B. Long touch to turn off the induction function.
- C. Note: When you touch the light button to change the light modes, the induction function will automatically turn off. It is best to turn on this function after selecting the light color and adjusting the brightness you want.

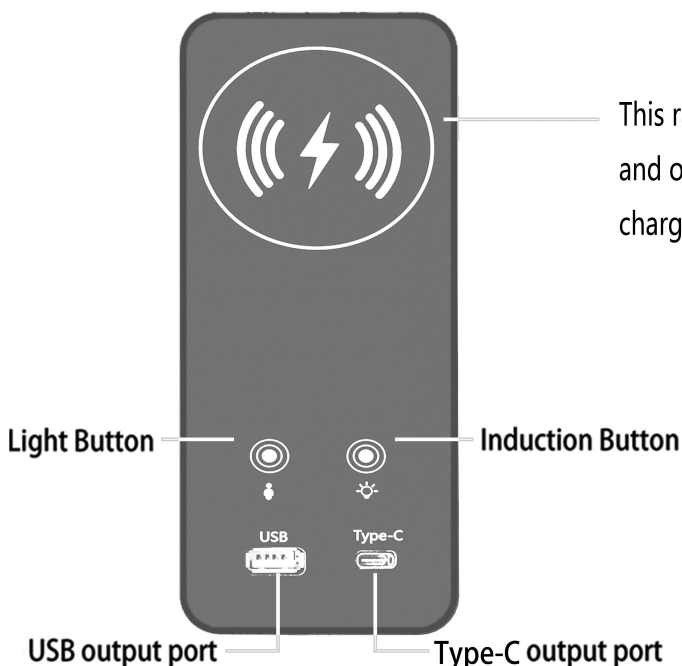

ATTENTION PLEASE

1. If there is no touch response suddenly, Re-plug the power to reset the touch static electricity.
2. If bubbles appear on the panel, remove the protective film.
3. If you have any questions when installing, please feel free to contact us. Thank you.