



General Manual for Rolling Tree Planter 20 Gallon

Gardening Made Easier. Anytime, Anywhere.

Copyright © 2025 Vego



**Gardening
Made Easier.
Anytime,
Anywhere.**



Contact Us



+1 (866) 597-1888



Vego Garden Academy



hello@vegogarden.com



vegogarden.com



vego_garden















Houston, TX



vegogarden.com

Parts List

Parts	Set	Single Pack	Twin Pack
P1		4	8
B1		1	2
Non-Locking Caster		2	4
Locking Caster		2	4
F1 M6 x 18		4	8
F2 M6 x 10		16	32
F3 M6 x 14		12	24
F4 M6 Cap Nut		8	16
F5 M6 Standard Nut		8	16
T1		1	1
T2		1	1
SE		1	2
Gloves		1	1

Safety Precautions

This product may contain sharp metal corners and edges. To prevent injury:

- Handle with care at all times
- Wear gloves, closed-toe shoes & long pants when handling
- Work on a stable, clean surface away from children and pets
- Follow all instructions carefully and use tools only as directed

If you are unsure about any step, pause and seek assistance.



Assembly Guide

- 1 Remove protective film from both sides of all P1 curved panels.

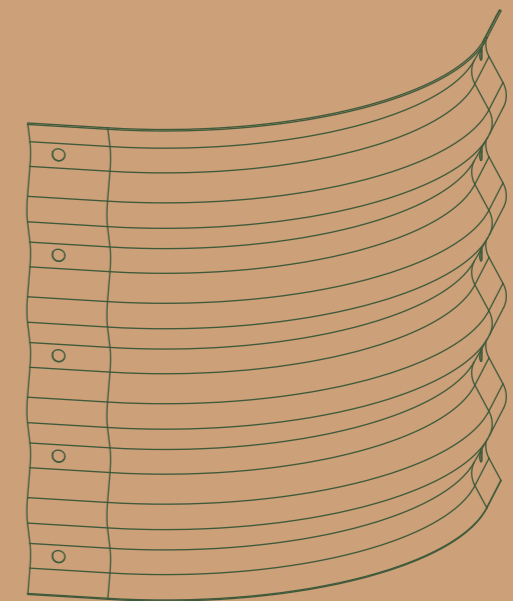
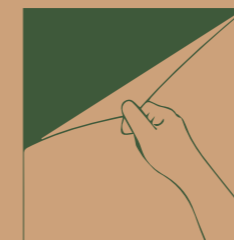

2 Take out the assembly support card from the package. Follow the diagram to fold it into a triangular support stand.

Note: The notched part should fold inward to lock the stand in place.

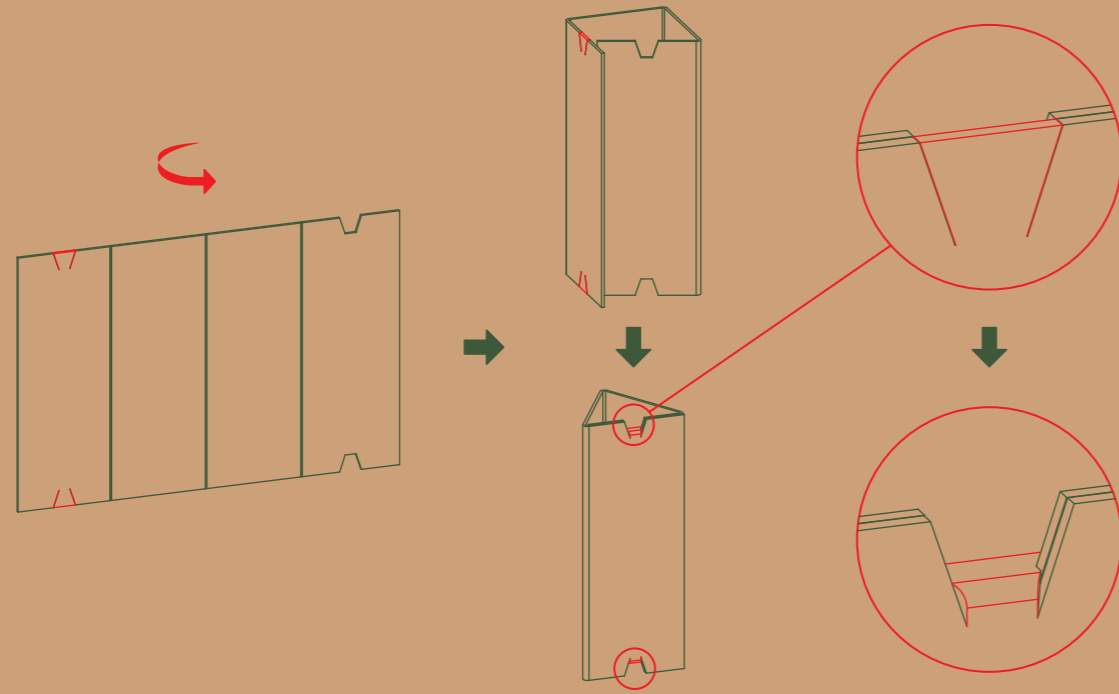

3 Put on gloves and place the B1 base on top of the triangular stand. Make sure the base is centered and stable, with the side that has the frame facing up.

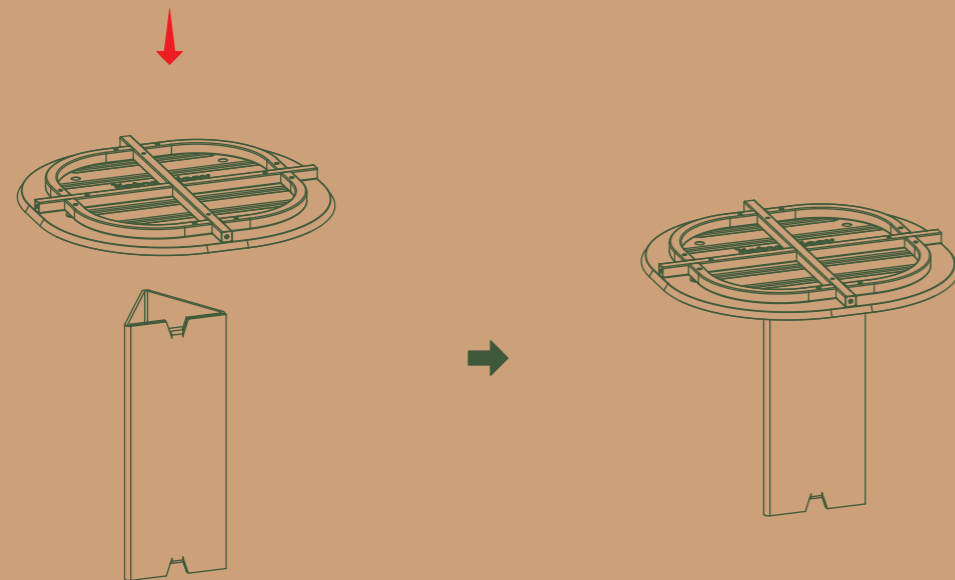

4 As shown in the diagram, place the P1 curved panels around the B1 base. Make sure the holes on each P1 panel line up with the holes on the base frame.

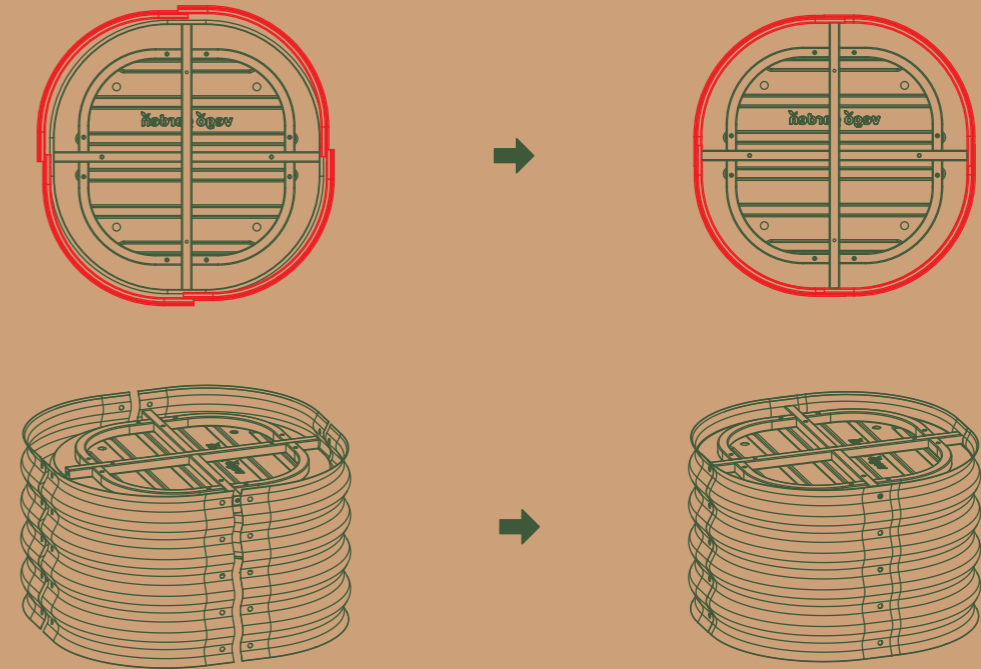

5 Attach the P1 panels to the B1 base using the F1 bolts.

Note: To make later assembly easier, do not fully tighten the F1 bolts yet.

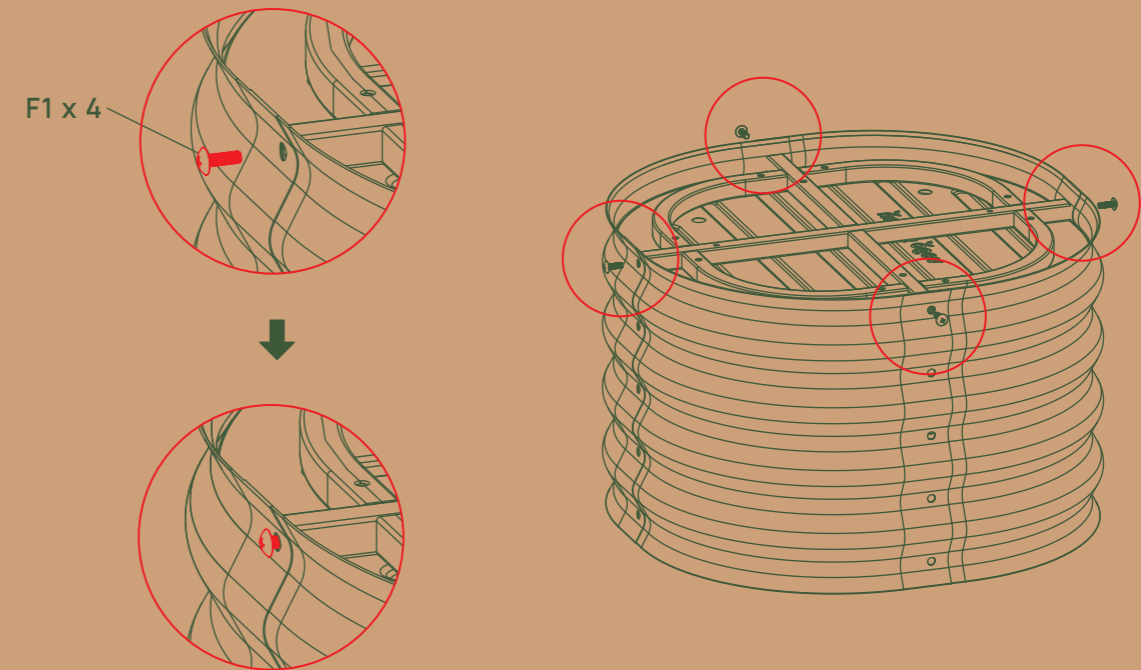

6 Use the T1 wrench and F3 bolts to secure both the locking and non-locking casters to the base frame.

Notes:

- The two locking casters should be installed diagonally, on opposite sides, for better locking control.
- Fully tighten all F3 bolts.

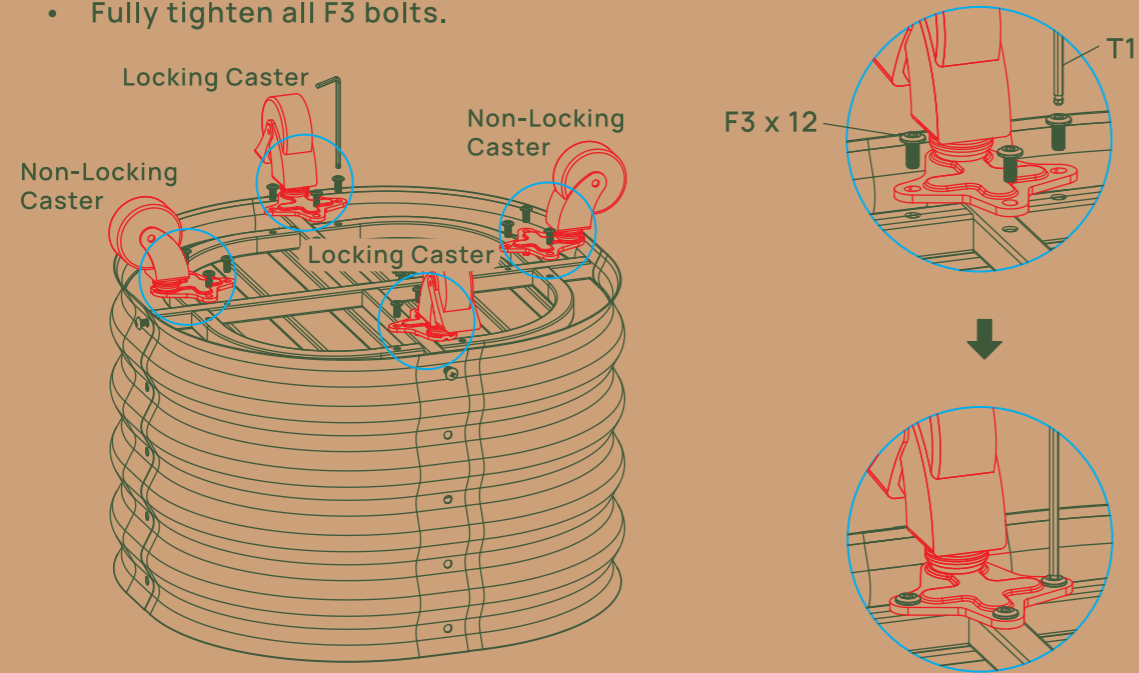

7 Gently turn the planter upside down. Connect the four curved panels together. Use the F2 bolts and F4 cap nuts for the top two rows, and use the F2 bolts and F5 standard nuts for the bottom two rows. Then use the T2 wrench to fully tighten all bolts.

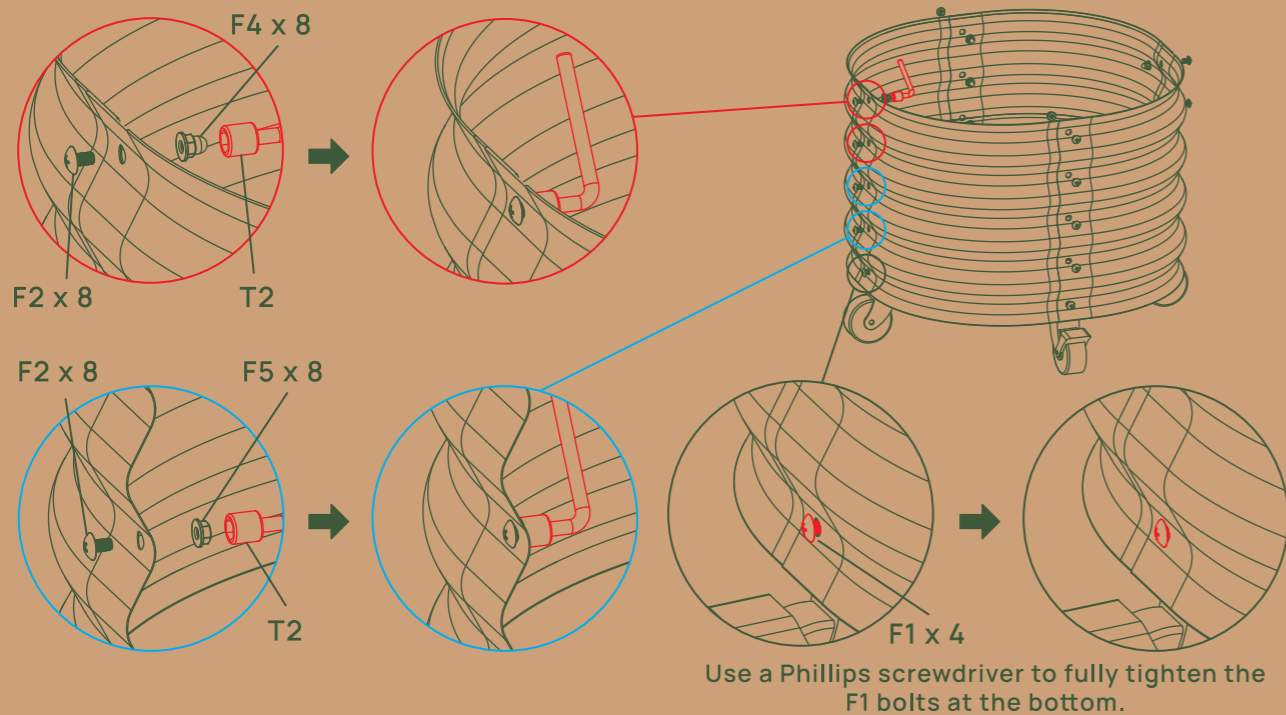

8 Carefully push the safety edging along the top rolled steel edge, guiding it into place.

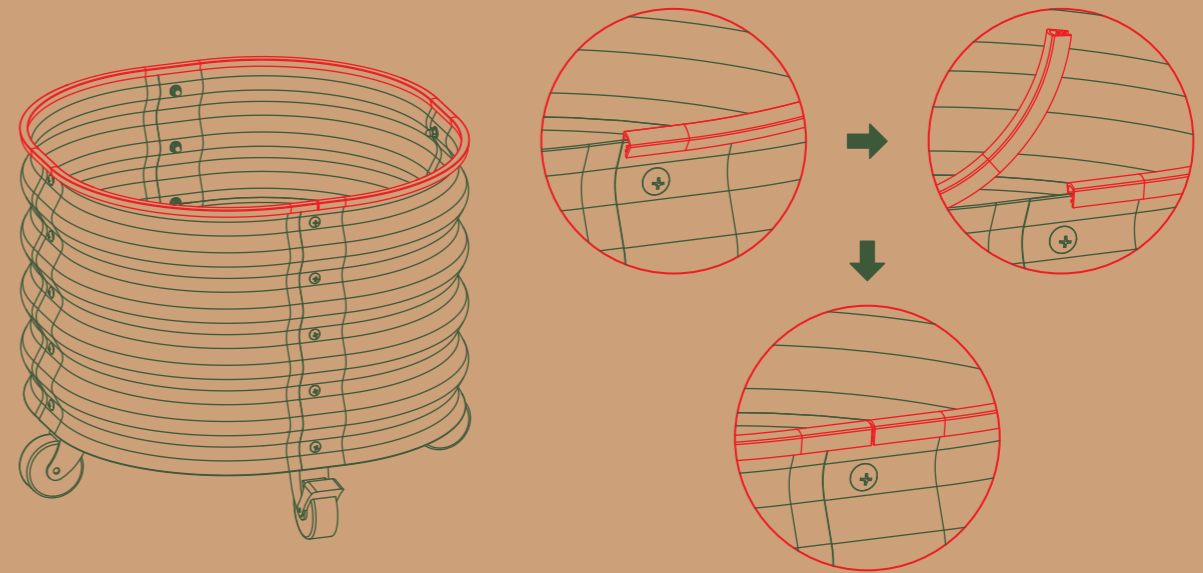

Important Caster Note

For optimal use, safety, and to prolong the lifespan of the casters please adhere to the following guidelines:

- Always engage the casters' brakes when the planter is stationary to prevent unintended movement.
- Avoid depressions or grooves deeper than 0.75 inches, as they may cause the casters to become unstable.
- Remove any small stones, debris, or obstacles that could hinder movement or damage the casters over time.
- Use only on the suitable surfaces listed below:

Suitable Surfaces

- Flat, stable surfaces
- Concrete
- Wooden & composite decks
- Pavers & tile

Unsuitable Surfaces

- Slopes or inclines
- Soft ground such as grass, soil, or sand
- Uneven gravel or rocky areas