

Assembly Instructions

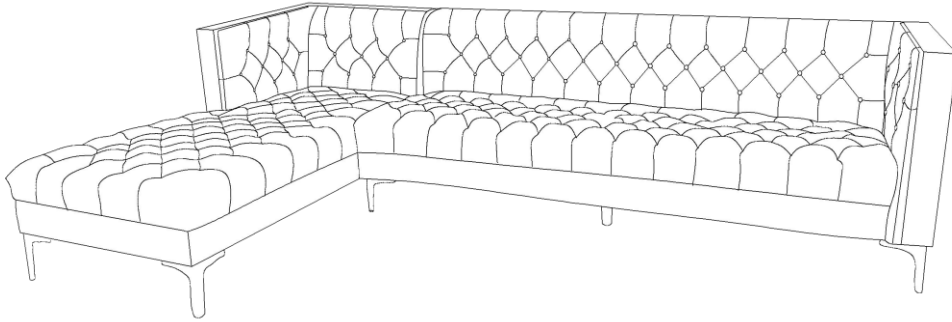

Caution: You must read this before you proceed

Sofa

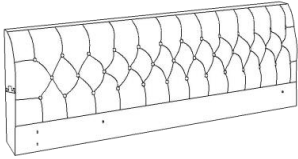
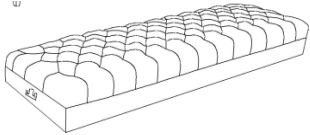
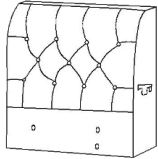
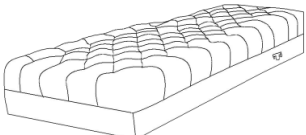
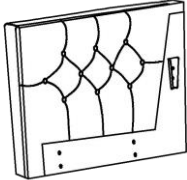

Parts List

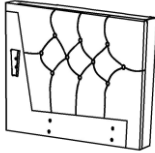
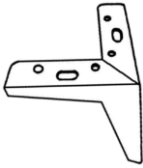
Label	Picture	Description	QTY(pc)
A		Sofa Backrest	1
B		Sofa Seat Base	1
C		Chaise Back	1
D		Chaise Seat Base	1
E		Left Arm	1

F		Right Arm	1
G		Metal Leg	8
H		Middle Leg with 1 Plastic Gasket	2

Hardware List

Label	Picture	Description	QTY
①		Plastic Gasket	2
②		Allen Key	1
③		Spring Ring(Φ13mm)	32
④		Big Flat Washer(Φ30mm)	16
⑤		Small Flat Washer(Φ22mm)	17
⑥		Bolt(M8*70mm)	16
⑦		Bolt(M8*30mm)	17

Assembly Preparation

Before
Beginning
Assembly:

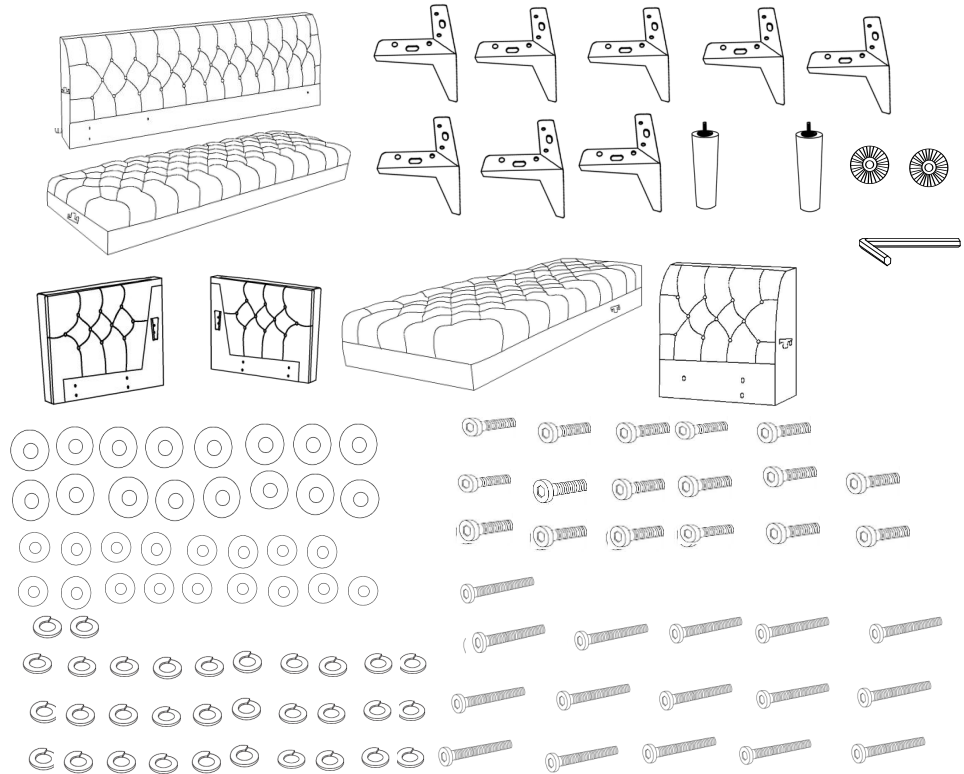

- Read instructions, cover to cover-



- Have 2 adults on hand for assembly-



- Do not assemble on flooring or carpet-



- Assemble on a clean non-marring surface (packing foam)-



- Save all packaging until finished-

Assembly Steps

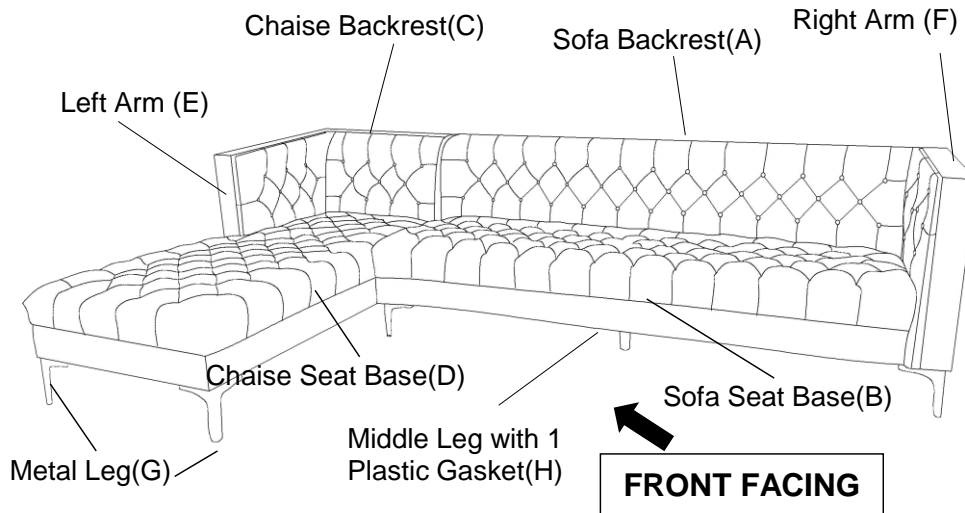

This Sofa has multiple parts and may require about 30 minutes to assemble. To give you an overview of the Sofa parts, the above picture is to help you put the various parts into perspective. Please read through the instructions below to familiarise yourself with the parts and steps before assembly.

Step 1

Carton "A"

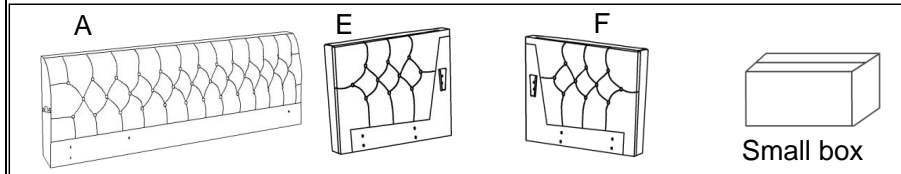

Take the Sofa Backrest(A), Left Arm(C), Right Arm(D) and Small Box out from the carton "A" and place them on a clean, non-marring surface.

Step 2

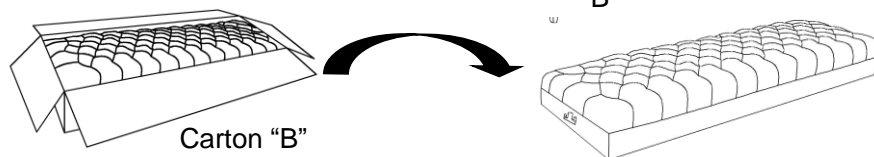

Take the Sofa Seat Base(B) from the carton "B" and place it on a clean, non-marring surface.

Step 3

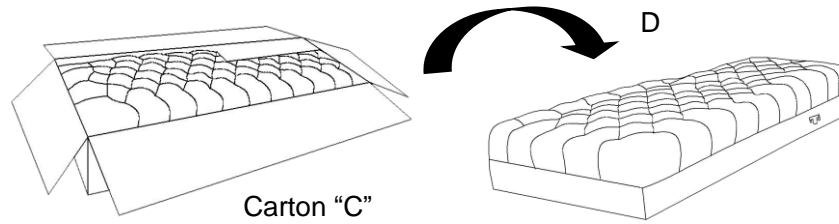

Take the Chaise Seat Base(D) from the carton "C" and place it on a clean, non-marring surface.

Step 4

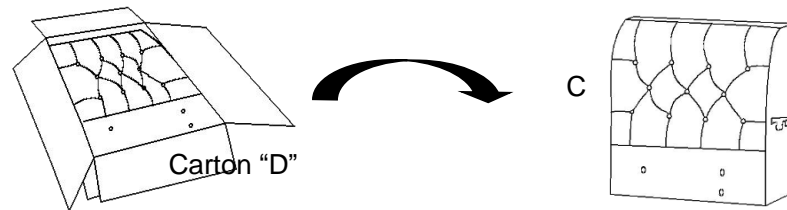

Take out the Chaise Back(C) from the Carton "D", place it on a clean, non-marring surface.

Step 5

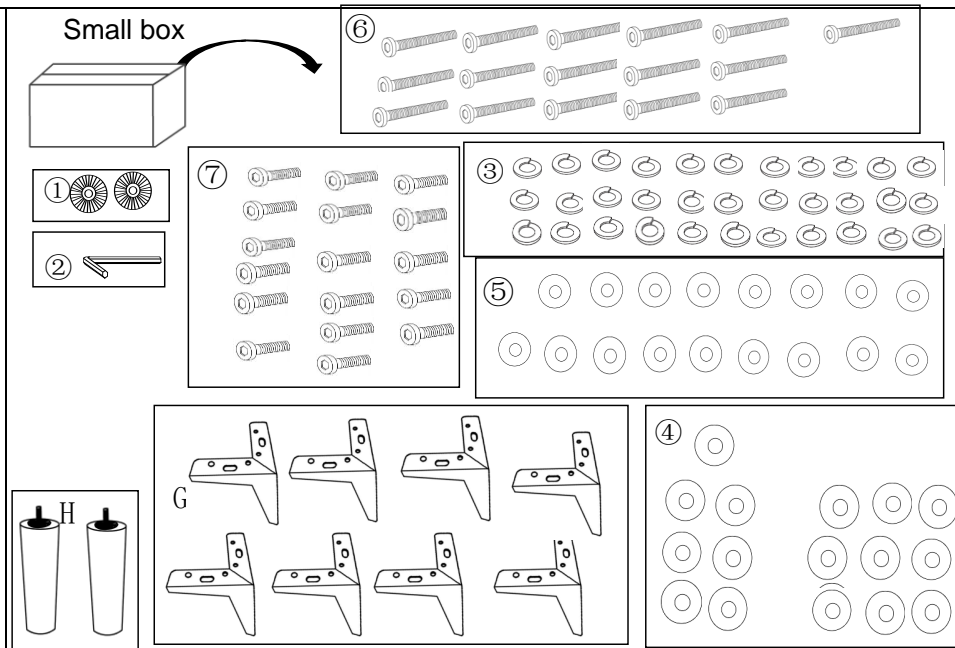

Open the Small Box to take out the Hardwares and Metal Legs(G) and Middle Legs(H) as shown above.

Step6

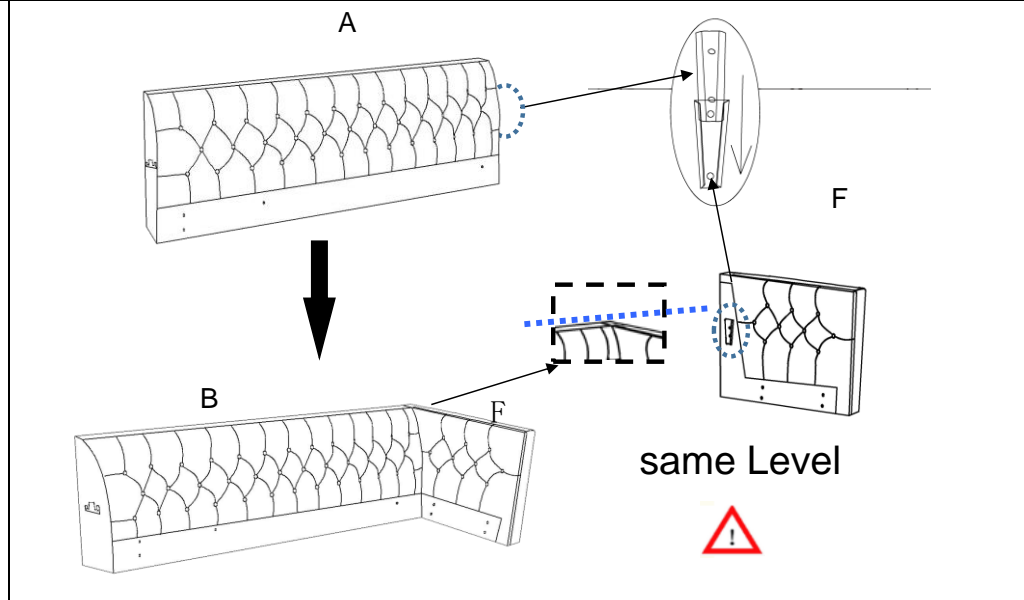

With assistance from your adult partner, align the mounting bracket on the Sofa Backrest(A) with those on the Right Arm(F). Then slide the Sofa Backrest(A) downwards to make sure it locks into place as pictured. Please squeeze the armrest properly against the backrest to ensure that the inserts can be assembled smoothly.

Step7

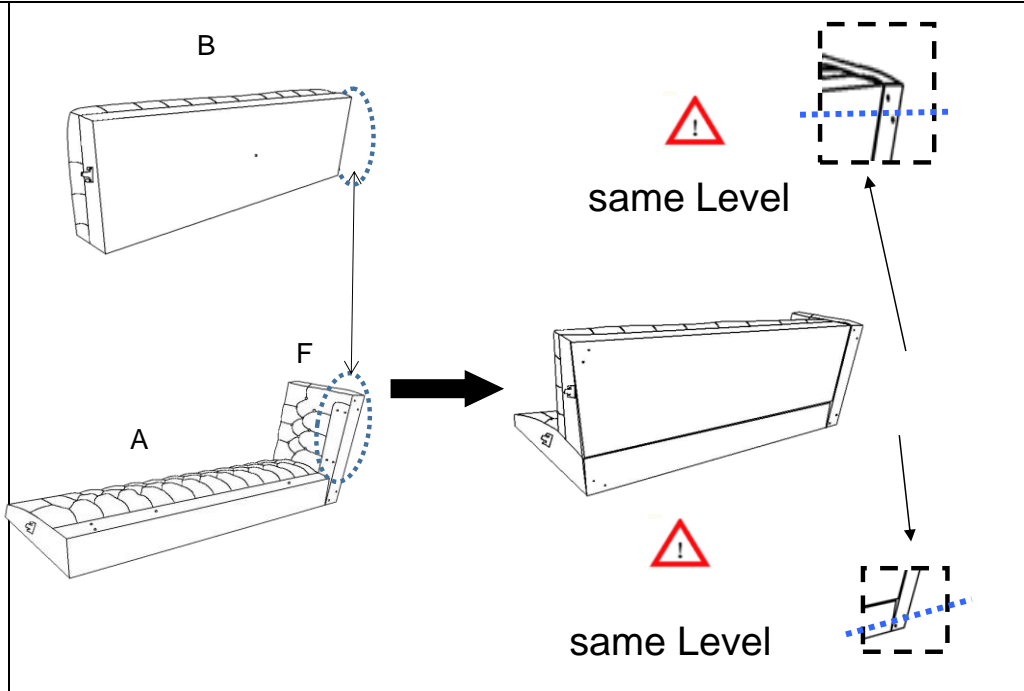

With assistance from your adult partner, align the mounting position on the hind and Right side of Sofa Seat Base(B) to the mounting position of the Sofa Backrest(A) and Right Arm(F) as pictured, make sure the bottom of the Right Arm(F), Sofa Backrest(A) and Sofa Seat Base(B) are at the same level.

Step 8

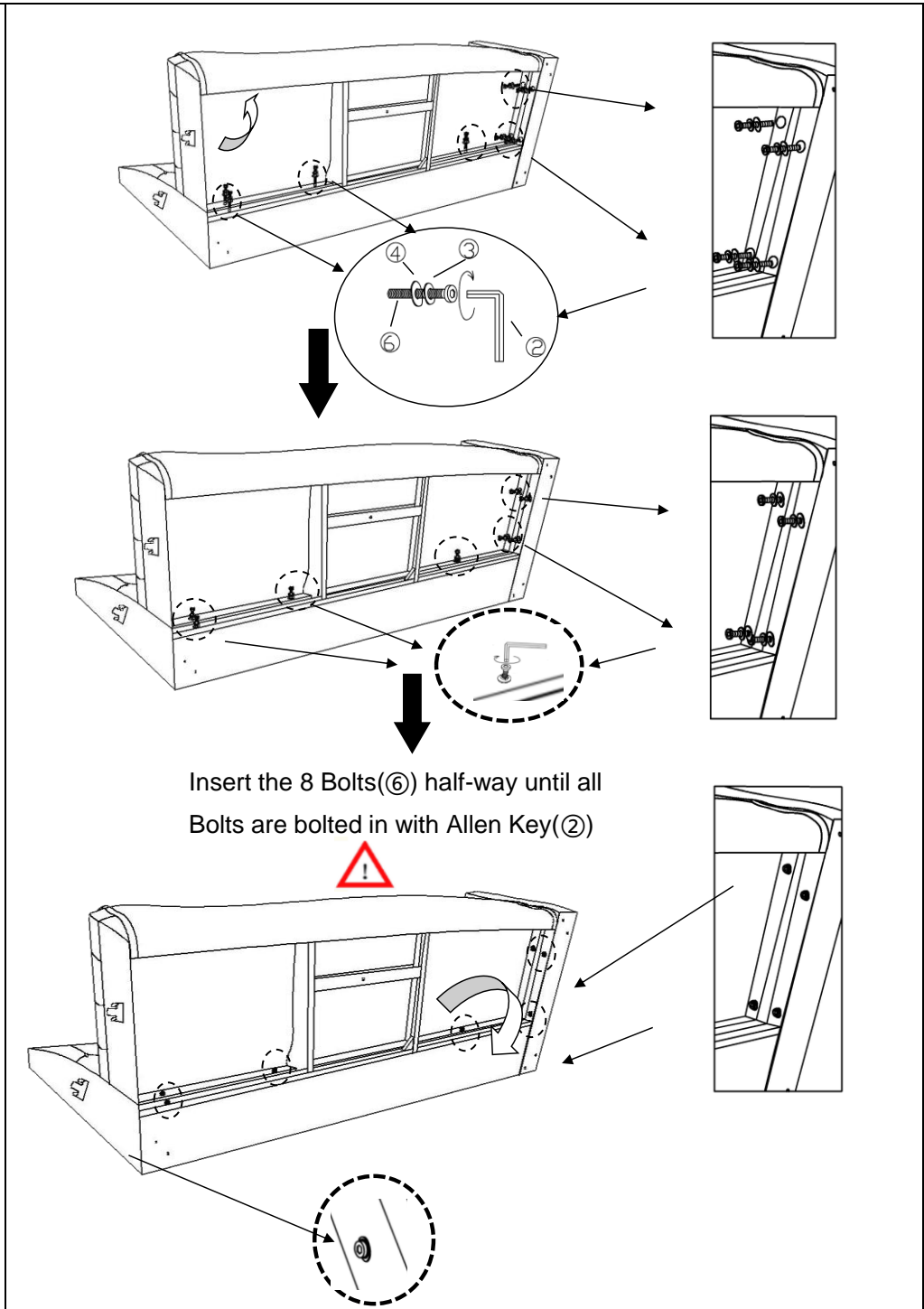

Open the Non-woven cover under the Seat Base(B).

Using the Allen Key(②), secure the Sofa Seat Base(B) to the front-bottom of the Sofa Backrest(A) and Right Arm(F) with Bolts(⑥), Spring Rings(③) and Big Flat Washers(④).

Insert all the Bolts(⑥) half-way starting one by one as pictured.

Then tighten the Bolts(⑥) with the Allen Key(②).

Close the non-woven fabric under the Sofa Seat Base(B) with Velcro.

Step 9

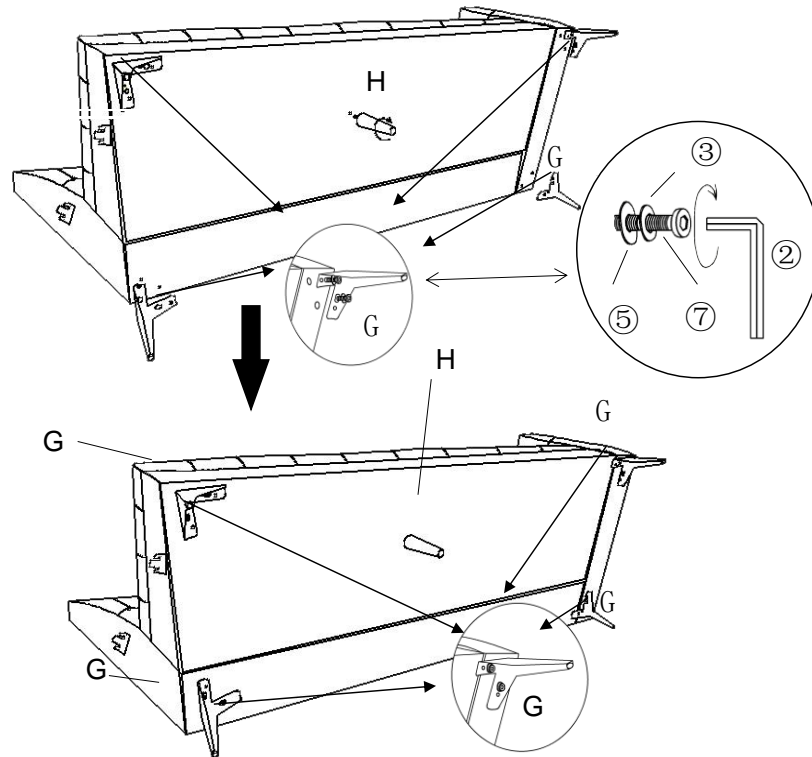

Carefully install the Metal Legs(G) at the bottom of Sofa Seat Base(B) using Bolts(7), Small Flat Washers(5), Spring Rings(3) and the Allen Key(2). And also install the Middle Leg with 1 Plastic Gasket(H) at the bottom of the Sofa Seat Base(B).

Step 10

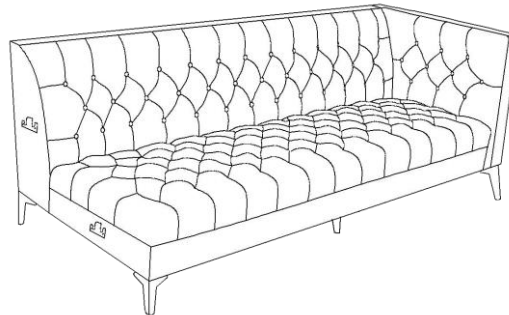

Now the Right Sofa is complete and ready for the other part to be assembled.

Step 11

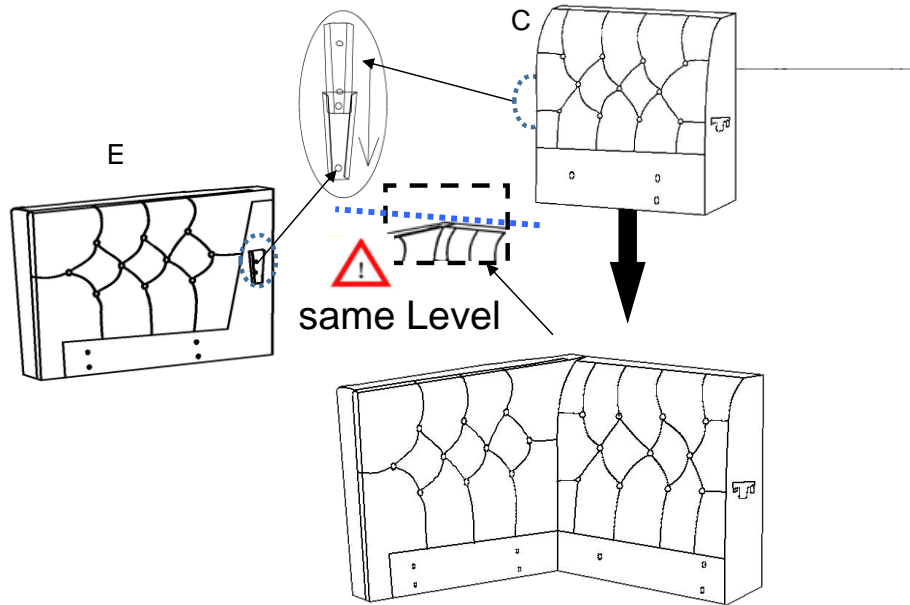

With assistance from your adult partner, align the mounting brackets on the Chaise Backrest(C) with those on the Left Arm(E).
Then slide the Chaise Backrest(C) downwards to make sure it locks into place as pictured.
Please squeeze the armrest properly against the backrest to ensure that the inserts can be assembled smoothly.

Step 12

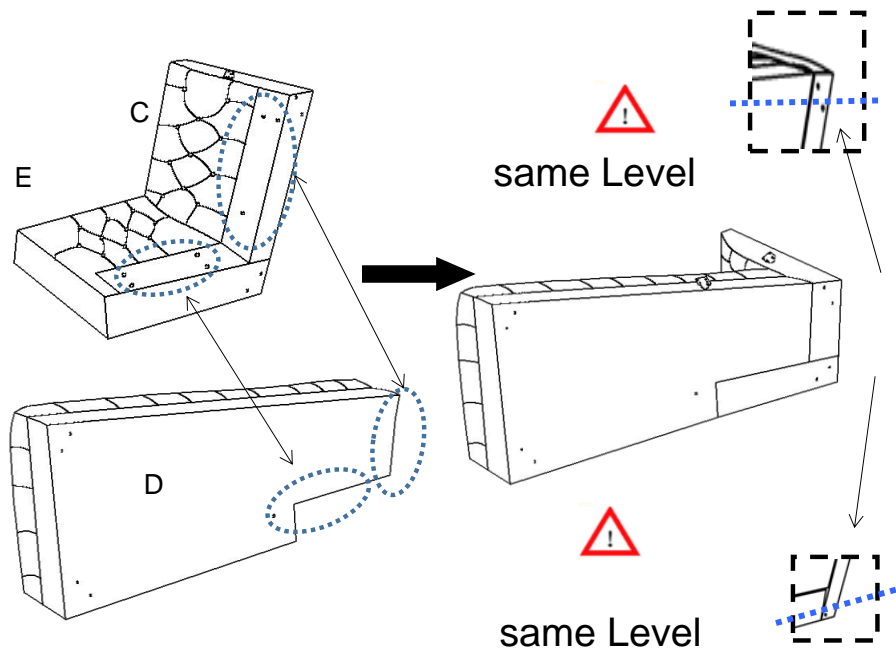

With assistance from your adult partner, align the mounting position on the hind and Left side of the Chaise Seat Base(D) to the mounting position of the Chaise Backrest(C) and Left Arm(E) as pictured above, make sure the bottom of the Left Arm(E), Chaise Backrest(C) and Chaise Seat Base(D) are at the same level.

Step 13

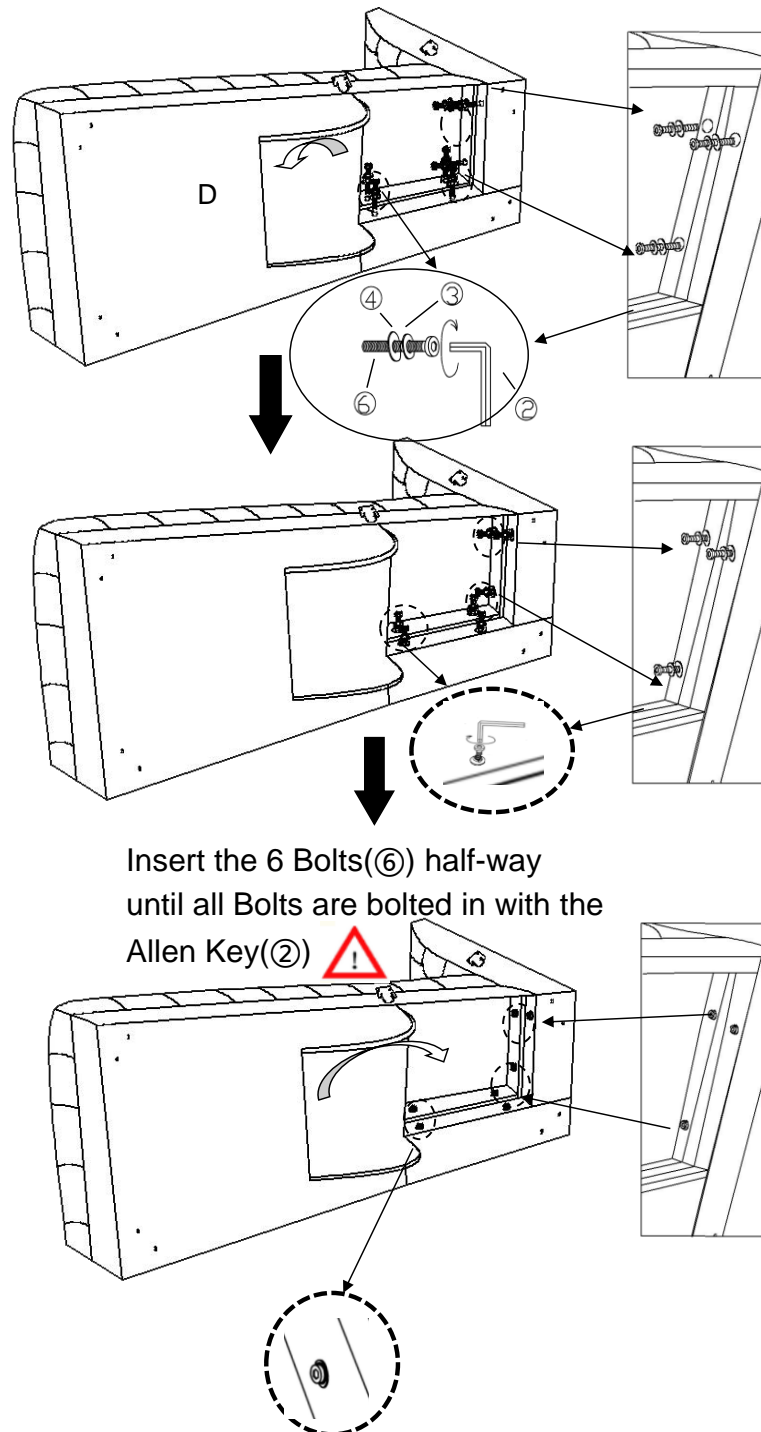

Insert the 6 Bolts(6) half-way until all Bolts are bolted in with the Allen Key(2) 

Open the Non-woven cover under Chaise Seat Base(D).
Using the Allen Key(2) secure Chaise Seat Base(D) to the front-bottom of Chaise Backrest(C) and Left Arm(C) with Bolts(6), Spring Ring(3) and Big Flat Washers(4).
Insert all the Bolts(6) half-way starting one by one as pictured.
Then tighten the Bolts(6) with the Allen Key(2).
Close the non-woven fabric under the Chaise Seat Base(D) with Velcro.

Step 14

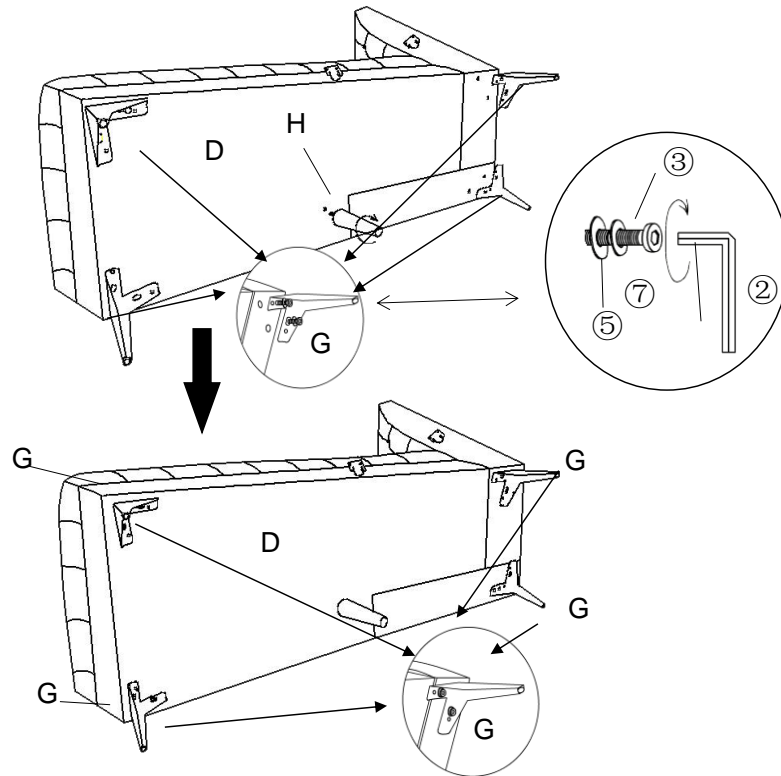

Carefully install the Metal Legs(G) at the bottom of the Chaise Seat Base(D) using Bolts(7), Small Flat Washers(5), Spring Rings(3) and the Allen Key(2). And also install the Middle Leg with 1 Plastic Gasket(H) at the bottom of the Chaise Seat Base(D).

Step 15

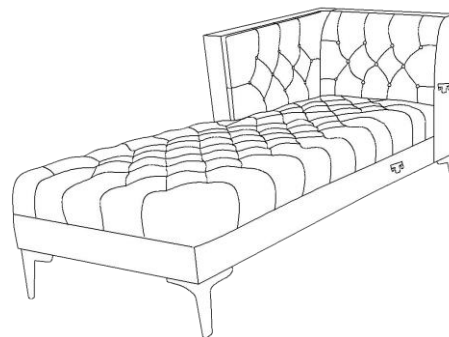

Now the Left Chaise is complete and ready for the other part to be Assembled.



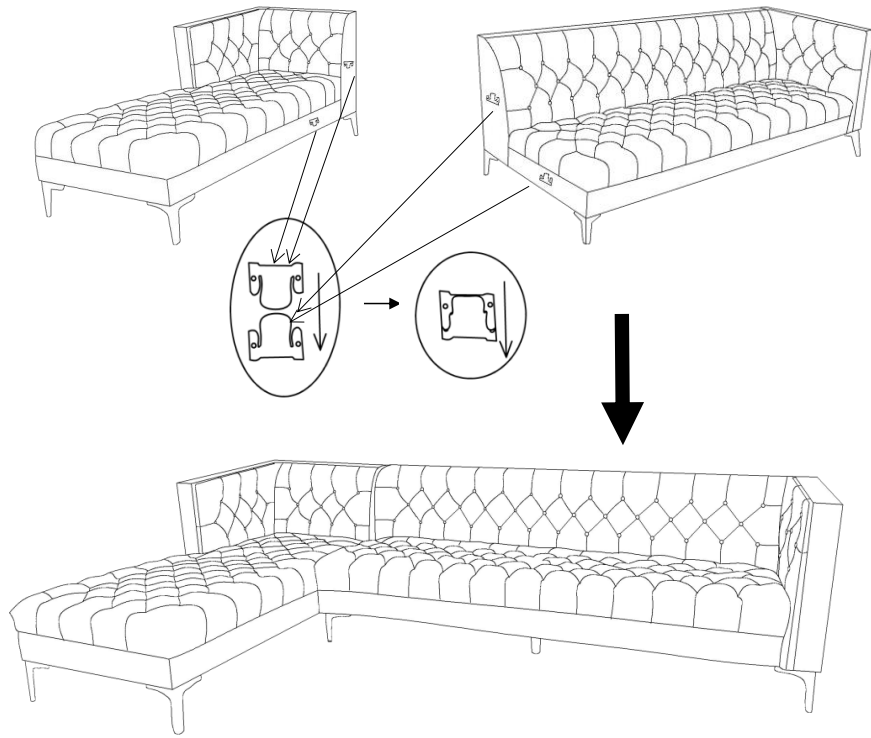







Step 16



Connect the Metal Brackets on the Left side of the Right sofa and the Right Side of the Left Chaise as pictured above.

Your Sofa is ready for use.

This Sofa can only be used on a flat, level surface.

Care & Maintenance	
	• Furniture may scratch floors. We recommend using furniture pads to protect your floors.
	• Do not put hot items directly on furniture surface.
	• Do not clean furniture with harsh cleansers or polish.
	• Do not place furniture under direct sunlight.
	• Do not place furniture near heating or cooling vents.
	• Do not write on furniture without a padded barrier to protect the surface.
	• Do not place furniture outside . For indoor use only.
	• Not for commercial use. For residential use only.
	• Stains may be removed with mild soap solution and damp cloth.
	• Children should not climb or jump on the furniture.
	• Dust and pick-up spills using a clean, non-colored, lint-free cloth.

Questions & Answers about Proposition 65

- What is Proposition 65?

Proposition 65 requires businesses to provide warnings to Californians about significant exposures to chemicals that cause cancer, birth defects or other reproductive harm. These chemicals can be in the products that Californians purchase, in their homes or workplaces, or that are released into the environment. By requiring that this information be provided, Proposition 65 enables Californians to make informed decisions about their exposures to these chemicals. Proposition 65 also prohibits California businesses from knowingly discharging significant amounts of listed chemicals into sources of drinking water.

Proposition 65 requires California to publish a list of chemicals known to cause cancer, birth defects or other reproductive harm. This list, which must be updated at least once a year, has grown to include approximately 900 chemicals since it was first published in 1987.

- What types of chemicals are on the Proposition 65 list?

The list contains a wide range of naturally occurring and synthetic chemicals that include additives or ingredients in pesticides, common household products, food, drugs, dyes, or solvents. Listed chemicals may also be used in manufacturing and construction, or they may be byproducts of chemical processes, such as motor vehicle exhaust.

- What does a warning mean?

If a warning is placed on a product label or posted or distributed at a workplace, a business, or in rental housing, the business issuing the warning is aware or believes that it is exposing individuals to one or more listed chemicals.

By law, a warning must be given for listed chemicals unless the exposure is low enough to pose no significant risk of cancer or is significantly below levels observed to cause birth defects or other reproductive harm.

- Where can I get more information on Proposition 65?

If you have specific questions on the administration or implementation of Proposition 65, you can contact OEHHA's Proposition 65 program at P65.Questions@oehha.ca.gov, or by phone at (916) 445-6900.