

# Owner Manual

Step ①

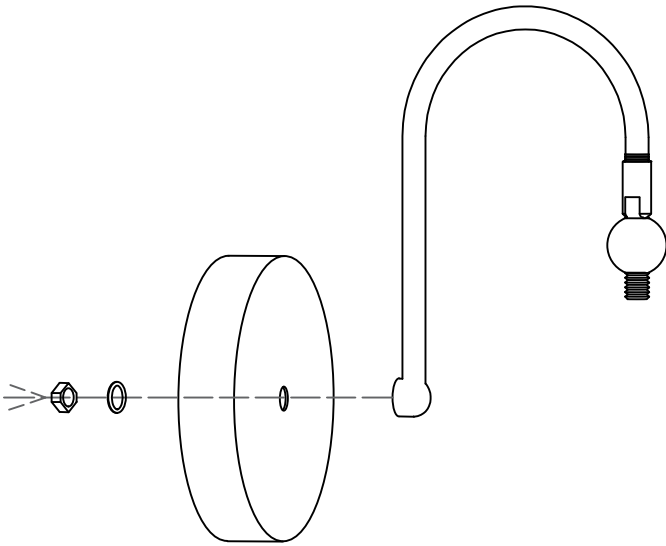

Step ②

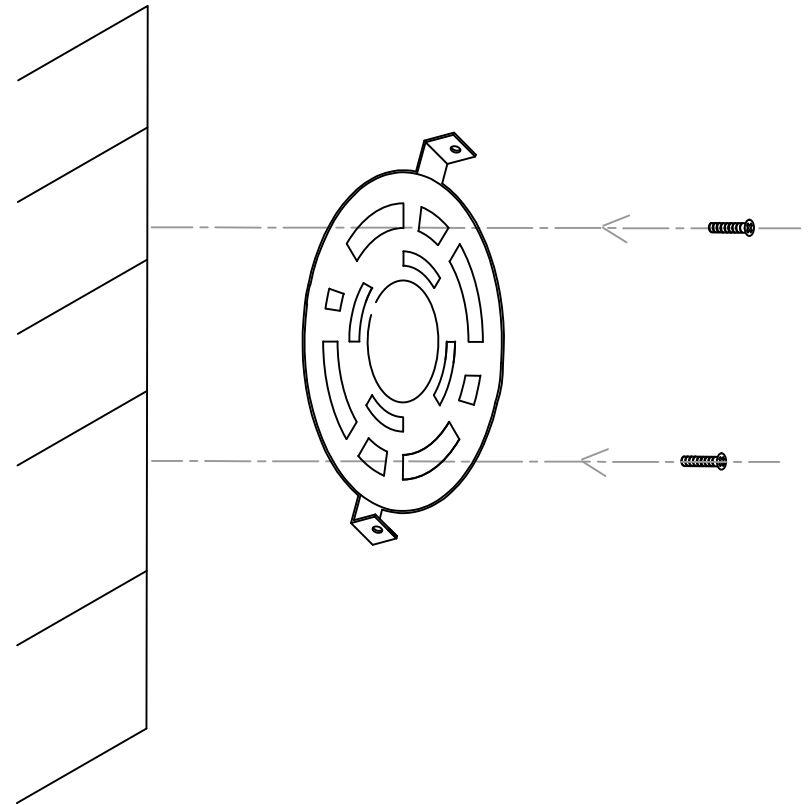

# Step 3

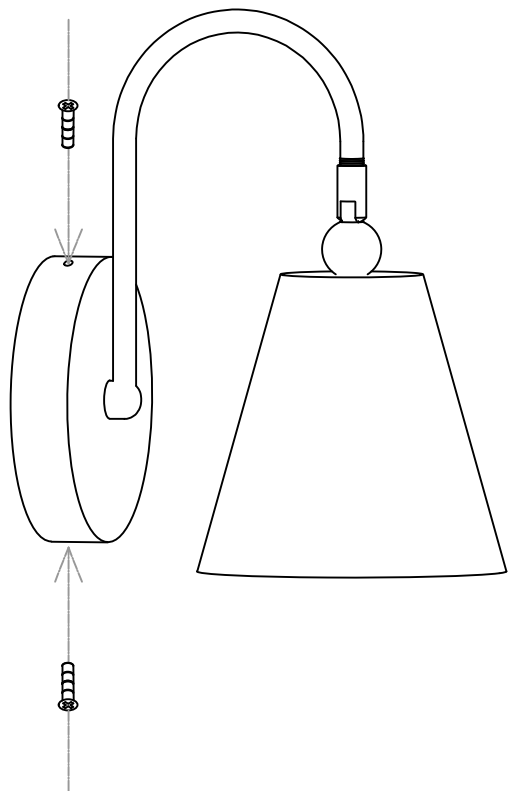

# Step 4

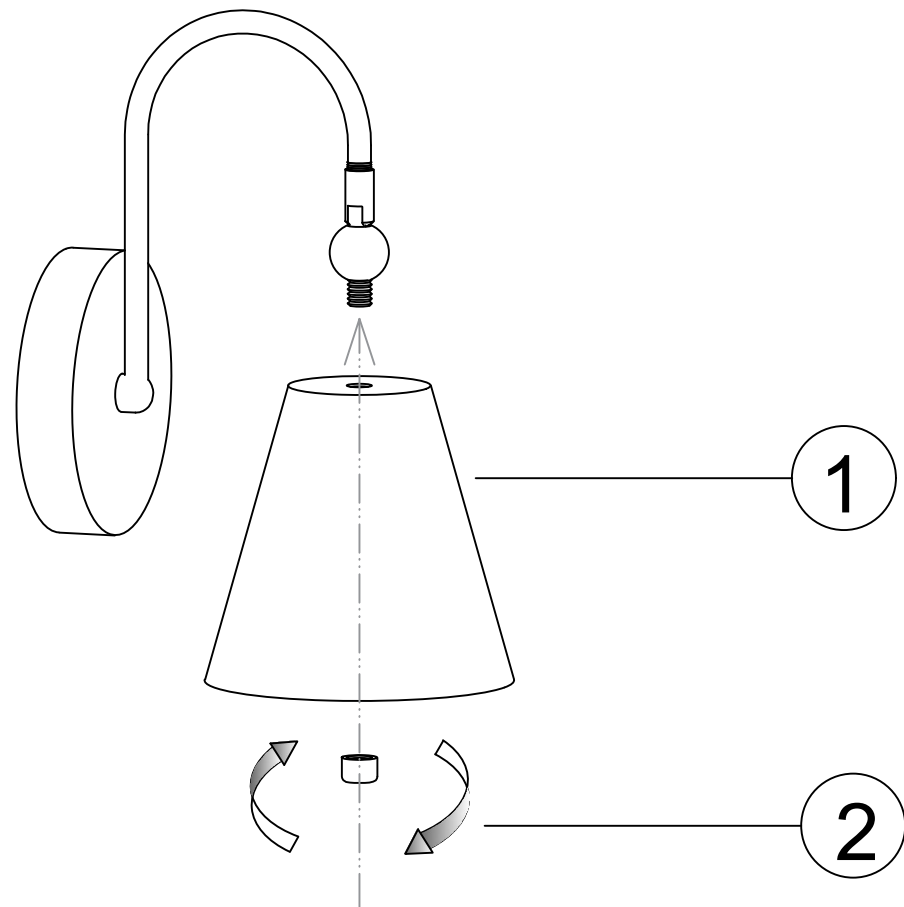

# Step

5

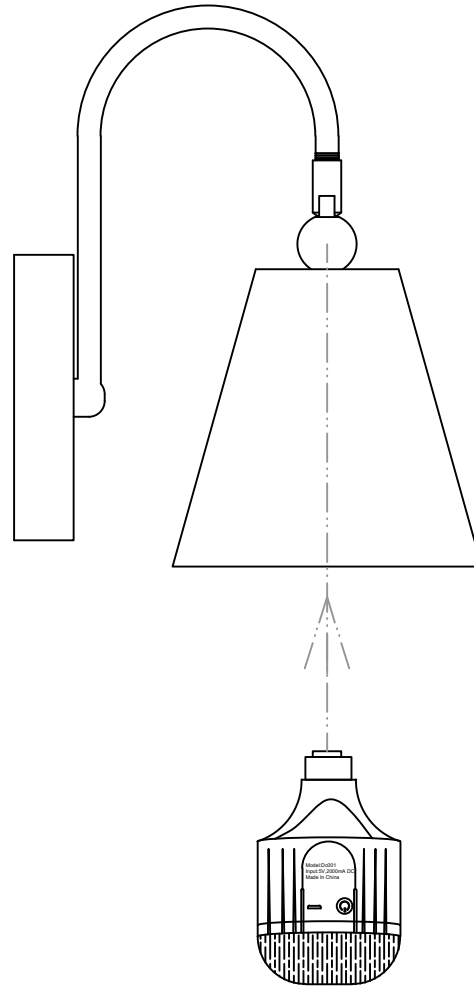

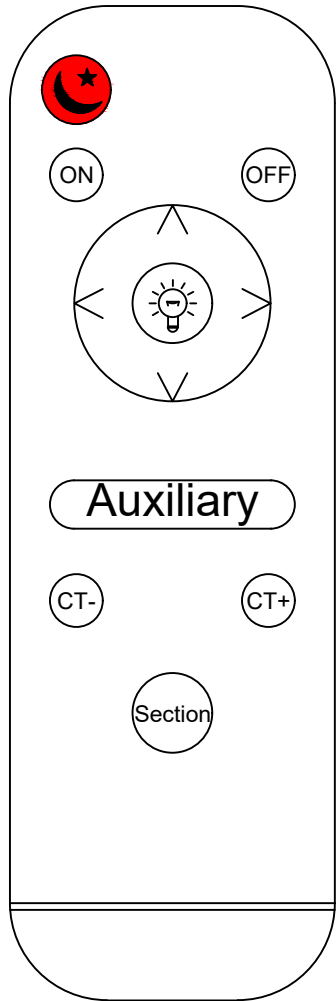

Night Light Mode: Once push this button, light bulb will work at low light output as a Night light. Once you push this button, other buttons will not response, you can only go back to normal light mode by push button "Section".



Section: Push this button to get three color temperature- -- Warm Light(3000K), Day Light(4000K), Cool Light(6000K).



CT- and CT+: You can adjust the color temperature stepless by push this two buttons, push and release to adjust it. Don't push and hold the button.



Auxiliary: No function for this light bulb.



No function for this light bulb.

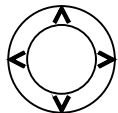

Adjust the brightness by pushing these buttons. Don't push and hold the button.