

**MODEL:IG10600013-1315**

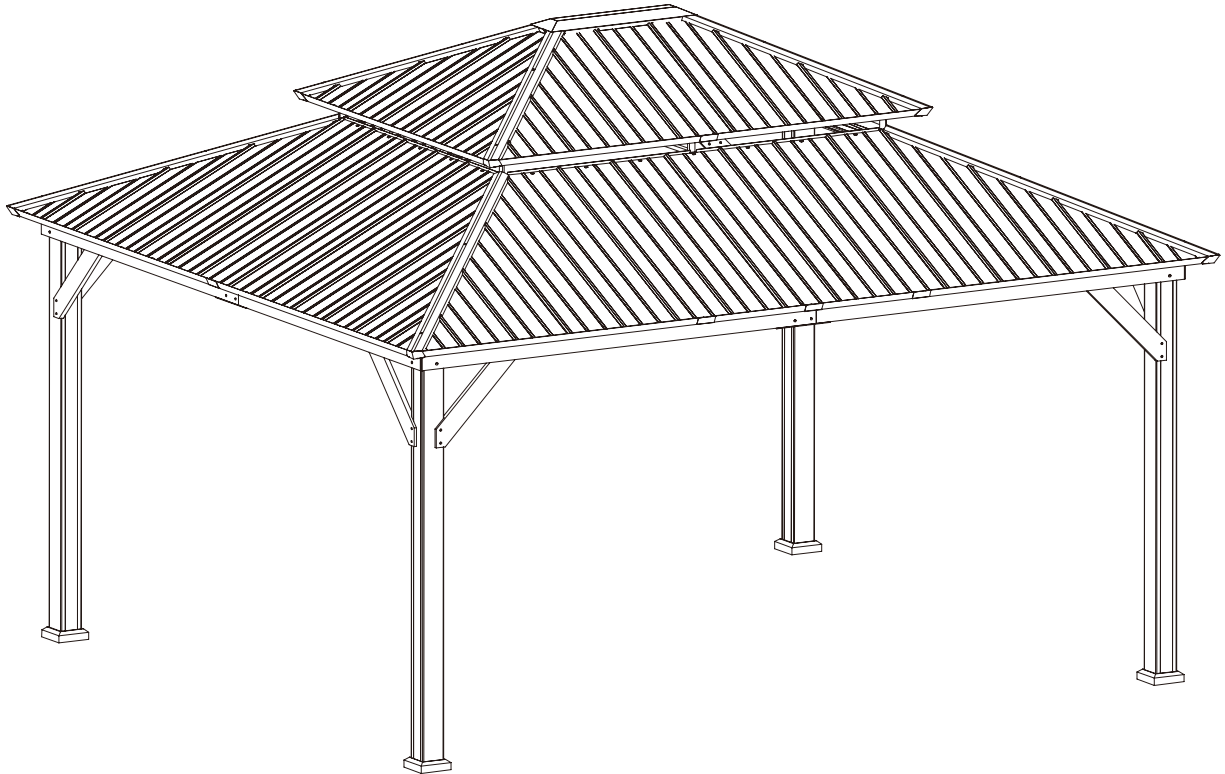

OWNER'S MANUAL

# Rosewood 13' x 15' Cedar Framed Hard Top Gazebo

## TABLE OF CONTENTS

ASSEMBLY GUIDE.....	02
USING YOUR PRODUCT.....	05

December 26, 2024

## QUESTIONS?



E-mail: [support@modernshade.org](mailto:support@modernshade.org)



Toll Free: 1-888-666-3070







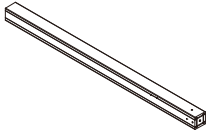
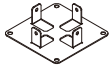

Mon-Fri: 9am---5pm PST.

CONTACT CUSTOMER SUPPORT BEFORE RETURNING PRODUCT TO RETAILER.

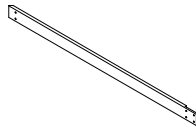
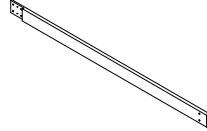
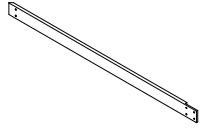
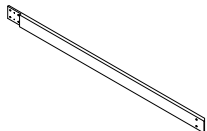
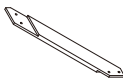
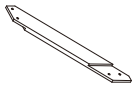
# ASSEMBLY GUIDE

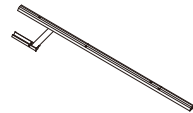
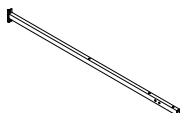
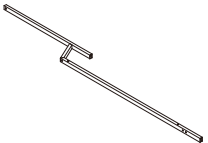
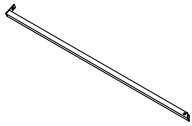
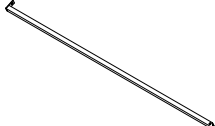
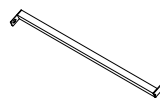
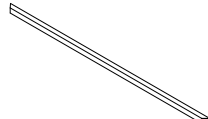
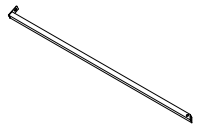
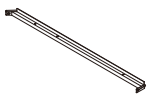
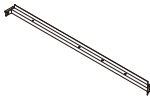
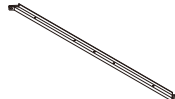
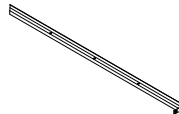
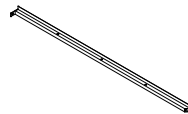
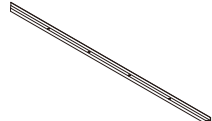
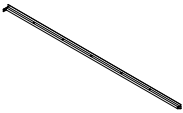
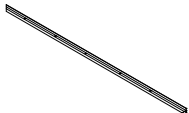
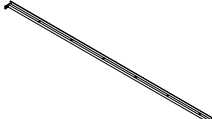
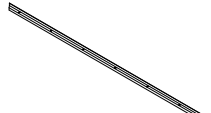
## PARTS LIST

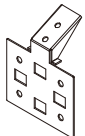
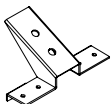
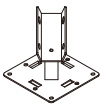
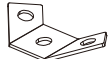
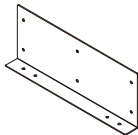
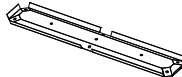
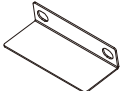
<b>A1</b> Post (4pieces) 	<b>B</b> Foot Base (4pieces) 	<b>C</b> Foot Cover (4pieces) 	<b>D1</b> Cross Beam 1 (2pieces) 	<b>D2</b> Cross Beam 2 (2pieces) 	<b>D9</b> Cross Beam 9 (2pieces) 
P0010000701	P0030000301	P0020000301	P0040001501	P0040001601	P0040002301
<b>D10</b> Cross Beam 10 (2pieces) 	<b>E1</b> Support Bracket 1 (4pieces) 	<b>E2</b> Support Bracket 2 (4pieces) 	<b>F1</b> Roof Rib 1 (4pieces) 	<b>F3</b> Roof Rib 3 (4pieces) 	<b>G1</b> Middle Cross Beam 1 (6pieces) 
P0040002401	P0050000501	P0050000601	P0070000202	P0070000801	P0080000601
<b>G2</b> Middle Cross Beam 2 (2pieces) 	<b>H5</b> Roof Support 5 (4pieces) 	<b>H6</b> Roof Support 6 (4pieces) 	<b>H7</b> Roof Support 7 (4pieces) 	<b>H11</b> Roof Support 11 (2pieces) 	<b>H12</b> Roof Support 12 (4pieces) 
P0080000701	P0090002301	P0090002401	P0090002601	P0090002901	P0090003001
<b>J1</b> Roof Upper Border 1 (2pieces) 	<b>J2</b> Roof Upper Border 2 (2pieces) 	<b>J4</b> Roof Upper Border 4 (2pieces) 	<b>K1</b> Connector 1 (2pieces) 	<b>K2</b> Connector 2 (2pieces) 	<b>K4</b> Connector 4 (2pieces) 
P0090003101	P0090003201	P0090003401	P0090003501	P0090003601	P0090003801
<b>L5</b> Roof Lower Border 5 (2pieces) 	<b>L6</b> Roof Lower Border 6 (2pieces) 	<b>L7</b> Roof Lower Border 7 (2pieces) 	<b>L8</b> Roof Lower Border 8 (2pieces) 	<b>L9</b> Roof Lower Border 9 (4 pieces) 	<b>M1</b> Connector 1 (4pieces) 
P0090003901	P0090004001	P0090004101	P0090004201	P0090004301	P0060001401
<b>M2</b> Connector 2 (4pieces) 	<b>M3</b> Connector 3 (4pieces) 	<b>M5</b> Connector 5 (16pieces) 	<b>M6</b> Connector 6 (4pieces) 	<b>M8</b> Connector 8 (1piece) 	<b>M9</b> Connector 9 (10pieces) 
P0060001501	P0060001701	P0060000602	P0110000701	P0060000702	P0110000502

# ASSEMBLY INSTRUCTIONS

- Please carefully unpack each of the components and hardware. check the components against the parts list and make sure there are no missing parts. lay pieces on cardboard or a soft mat to help protect the pieces from scratches.

**⚠ CAUTION**

Watch for sharp edges when handling the pieces, wear gloves to avoid injury.

**STEP 01#** Slide foot base **B** and foot cover **C** onto post **A1**. Use four (4) **[AA]** bolts to attach foot base **B** to post **A1**. Repeat with the other three (3) posts **A1**.

- For ease of assembly, it is recommended to have 3 or more people and allow enough time to completely finish the assembly. assembly can take 6-8 hours. a step-ladder is required for assembly (not included).
- Follow step by step instructions, and follow all safety warnings provided with your tools.
- DO NOT tighten screws until all the screws and washers are properly installed. Tighten screws securely, do not over tighten.
- Gazebo should not be used in inclement weather and high winds.

**STEP 02#** Attach four (4) **[JJ]** screw nuts to cross beam **D10**. Use four (4) **[FF]** bolts and four (4) **[LL]** flat washers to attach cross beam **D9** to connector **M1** and cross beam **D10**. Repeat with the other assembly.

**[AA]** x16

**[FF]** x8

**[LL]** x8

**[JJ]** x8

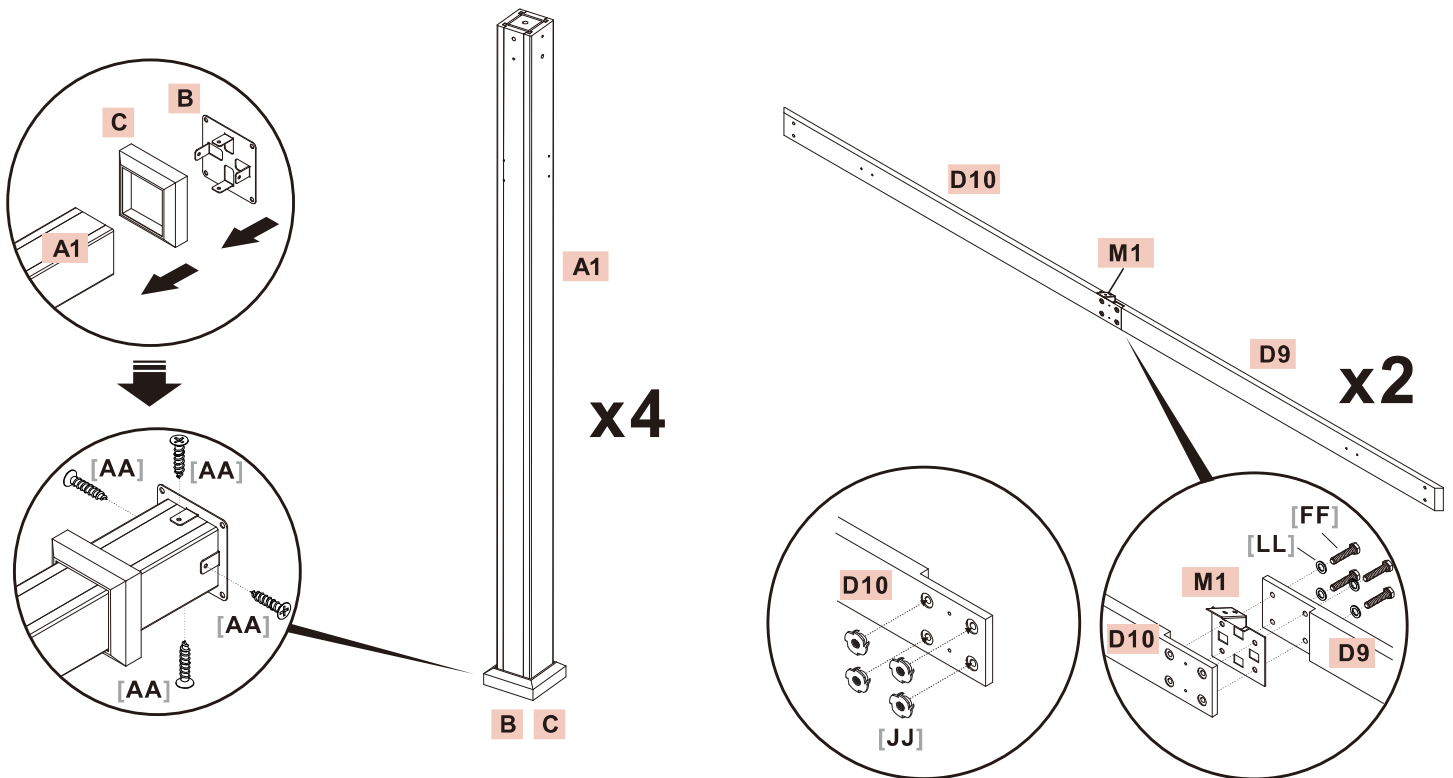

**STEP 03#**

Cover the connections between the cross beams with **M6** connectors and secure with (10) **[AA]** bolts each. Repeat to make a second assembly.

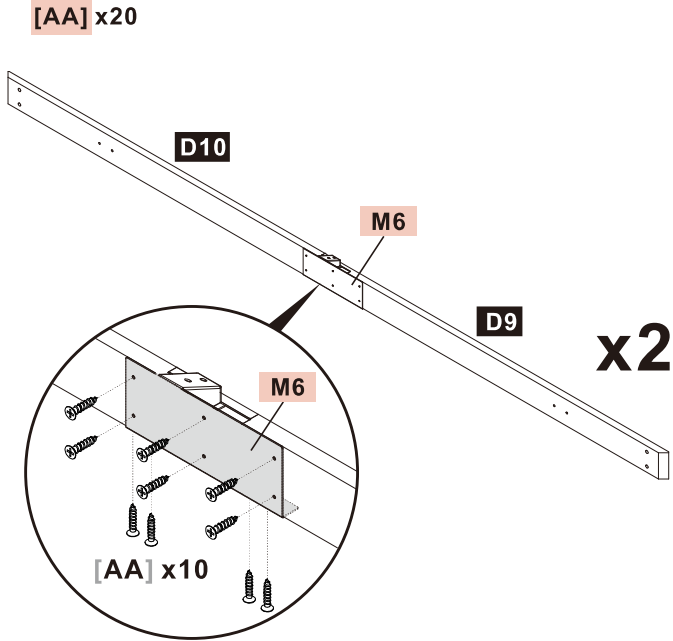

**STEP 05#**

Cover the connections between the cross beams with **M6** connectors and secure with (10) **[AA]** bolts each. Repeat to make a second assembly.

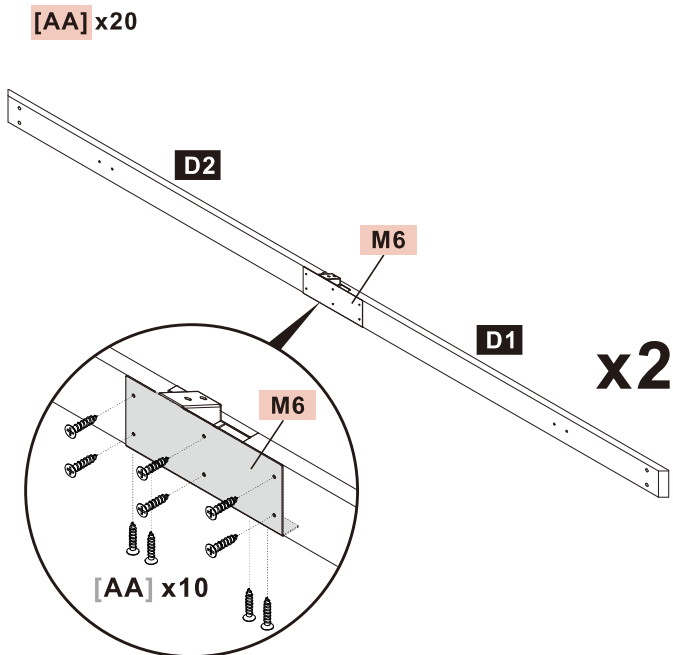

**STEP 04#**

Attach four (4) **[JJ]** screw nuts to cross beam **D2**. Use four (4) **[FF]** bolts and four (4) **[LL]** flat washers to attach cross beam **D1** to connector **M1** and cross beam **D2**. Repeat with the other assembly.

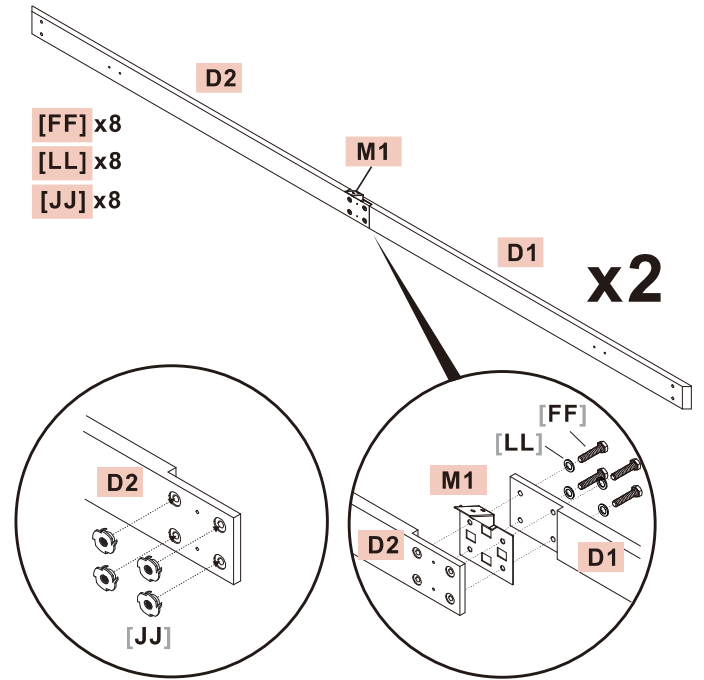

**STEP 06#**

Attach the cross beam assembly **D9 D10** to left **A1** post using one (1) **[CC]** bolt and **[MM]** washer in the top hole, and one (1) **[GG]** bolt, two (2) **[MM]** washers, and one (1) **[HH]** nut in the bottom hole. Attach the cross beam assembly to right **A1** post using one (1) **[GG]** bolt, two (2) **[MM]** washers, and one (1) **[HH]** nut in the top hole, and one (1) **[CC]** bolt and **[MM]** washer in the bottom hole. Repeat to make a second assembly.

