

Winnie ASSEMBLY INSTRUCTIONS

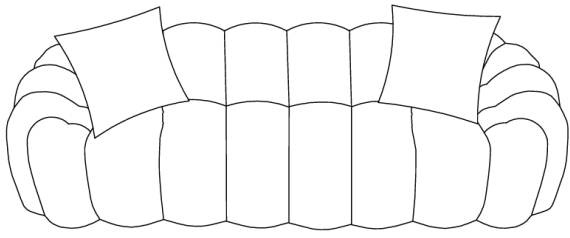

Option 1

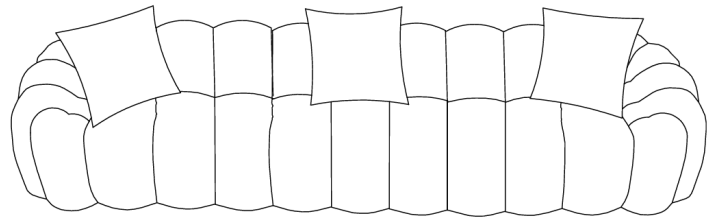

Option 2

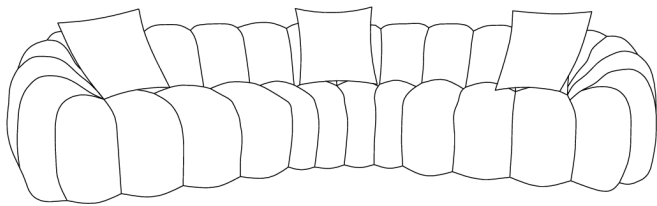

Option 3

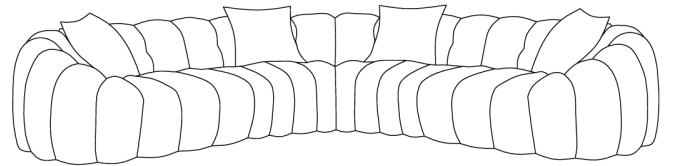

Option 4

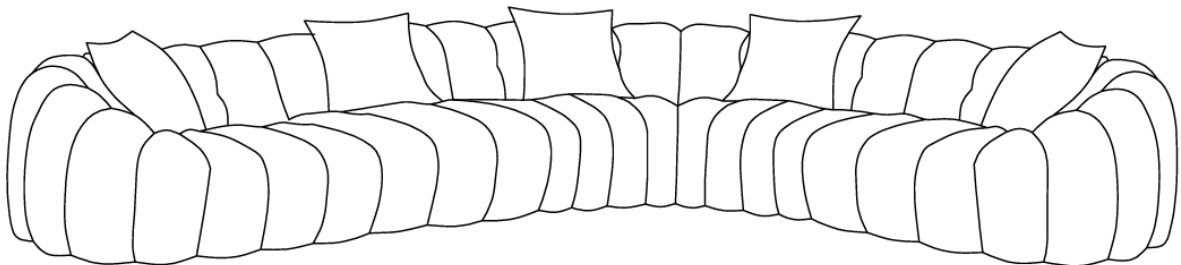

Option 5

Option 1

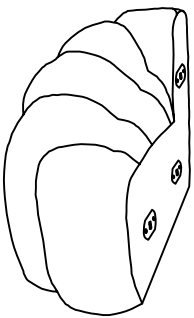
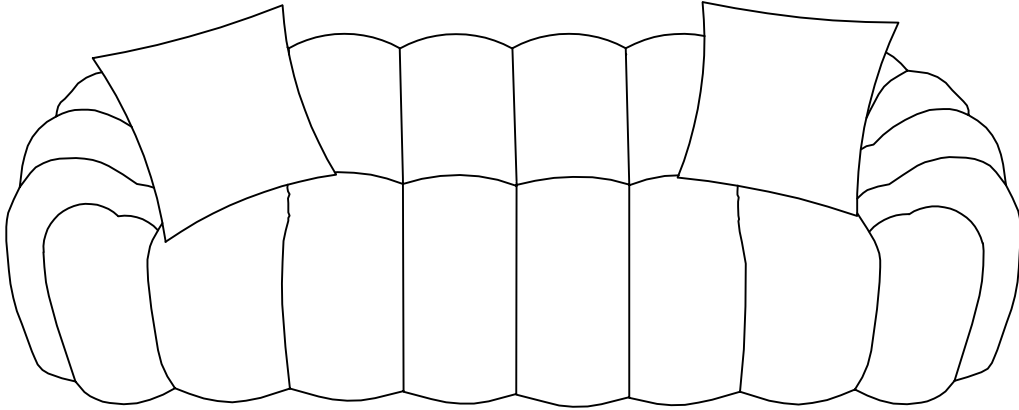

Ax1

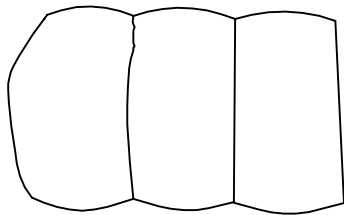

Bx2

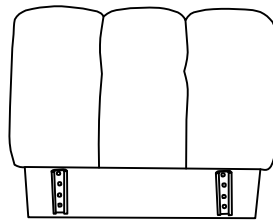

Cx2

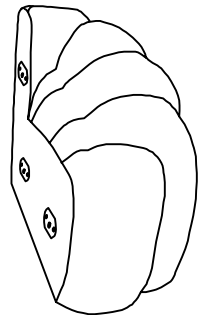

Dx1

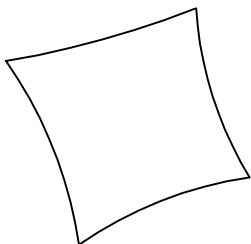

Ex2

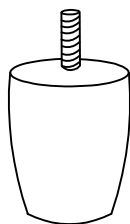

(1)x18



(2)x9

1

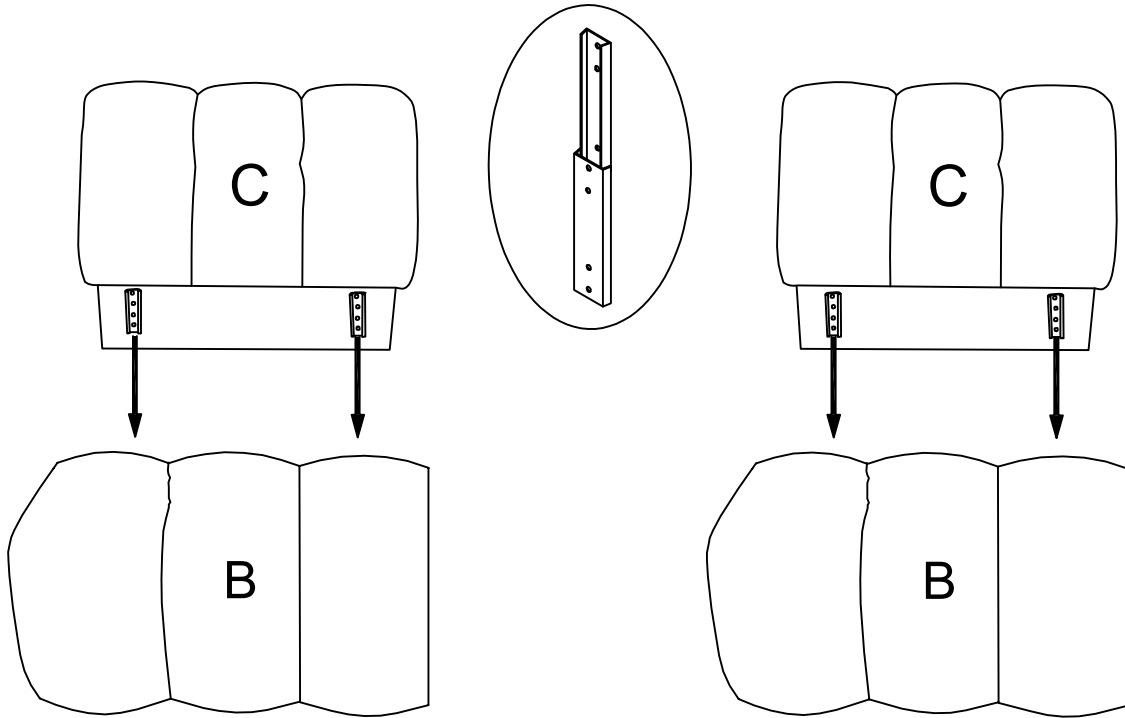

2

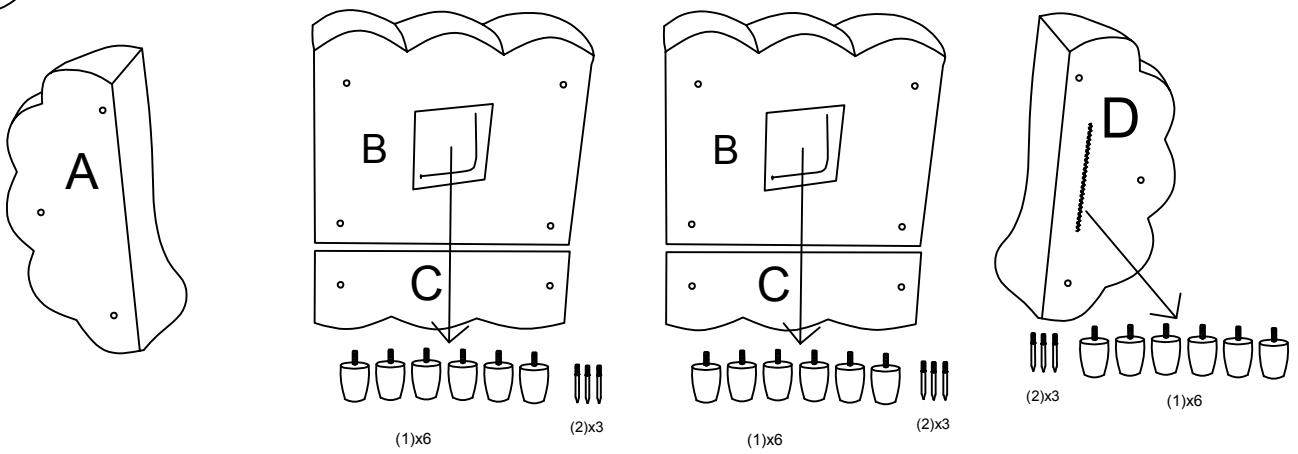

3

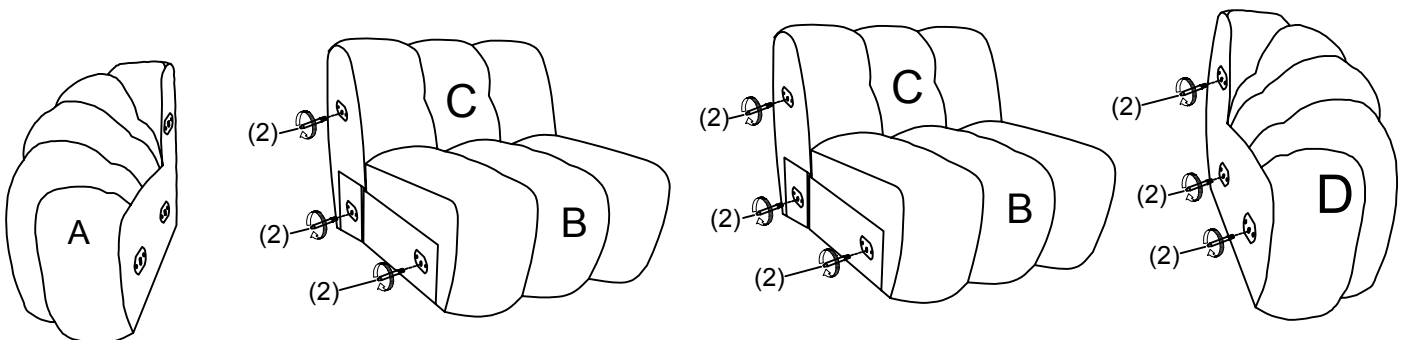

4

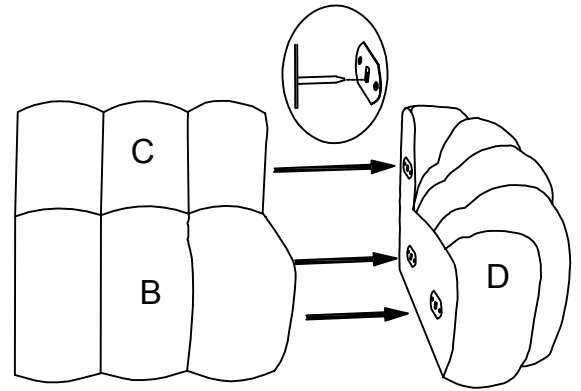
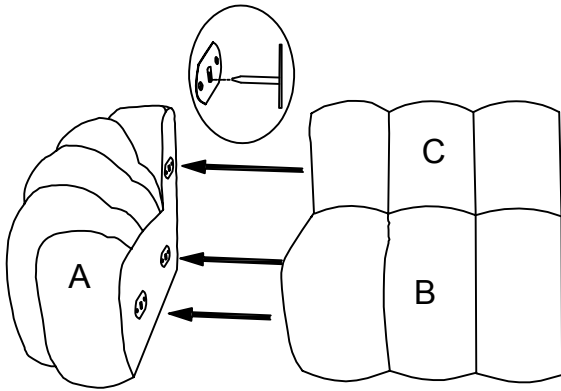

5

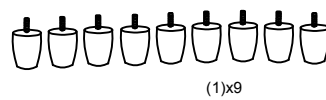
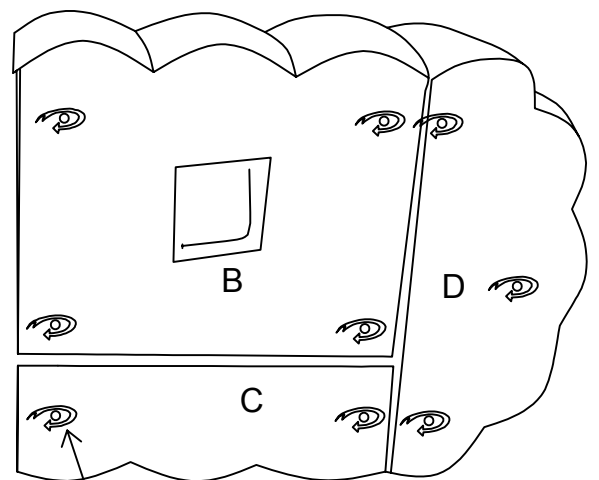
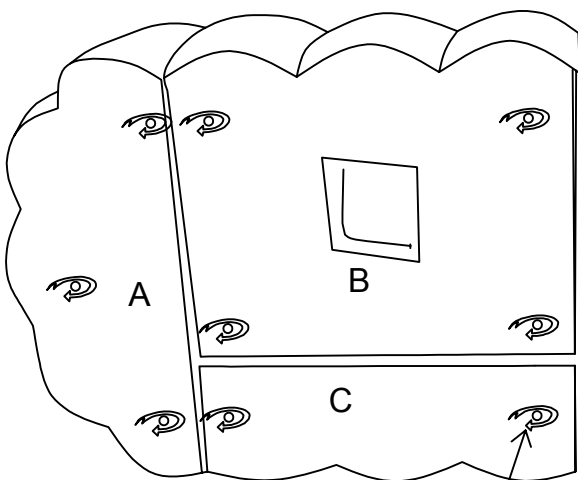

6

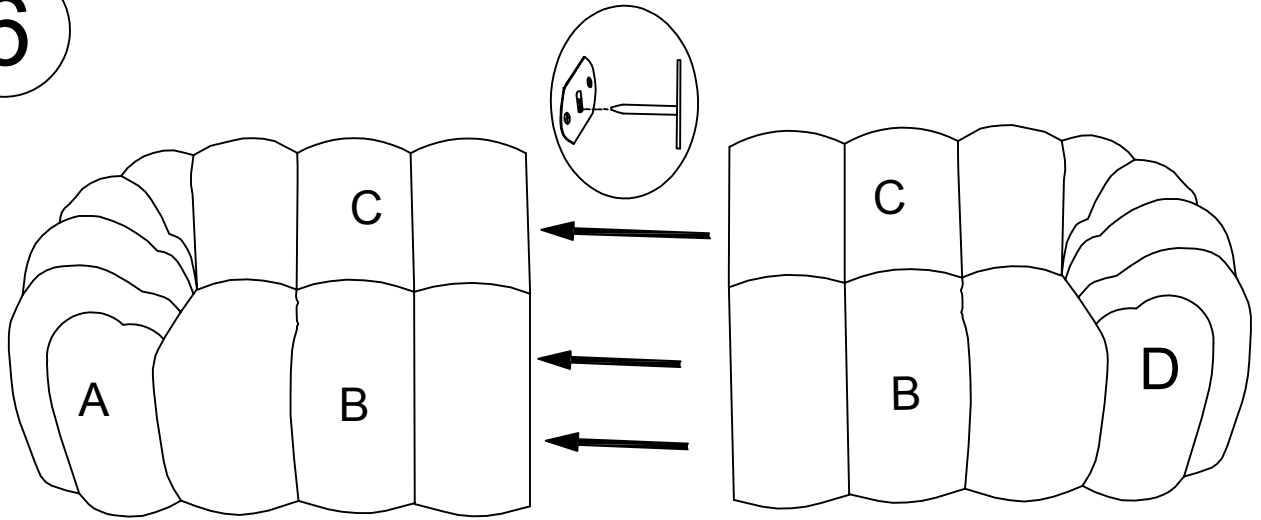

7

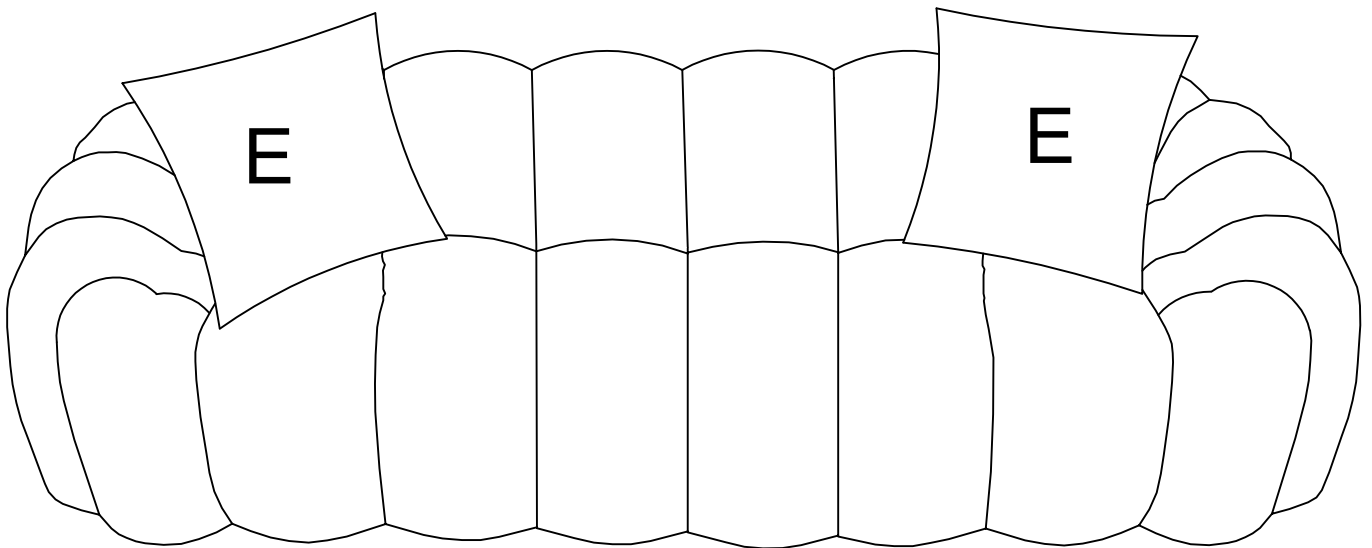

Option 2

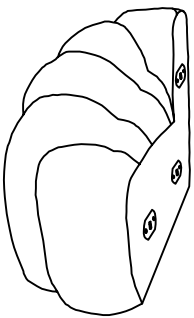
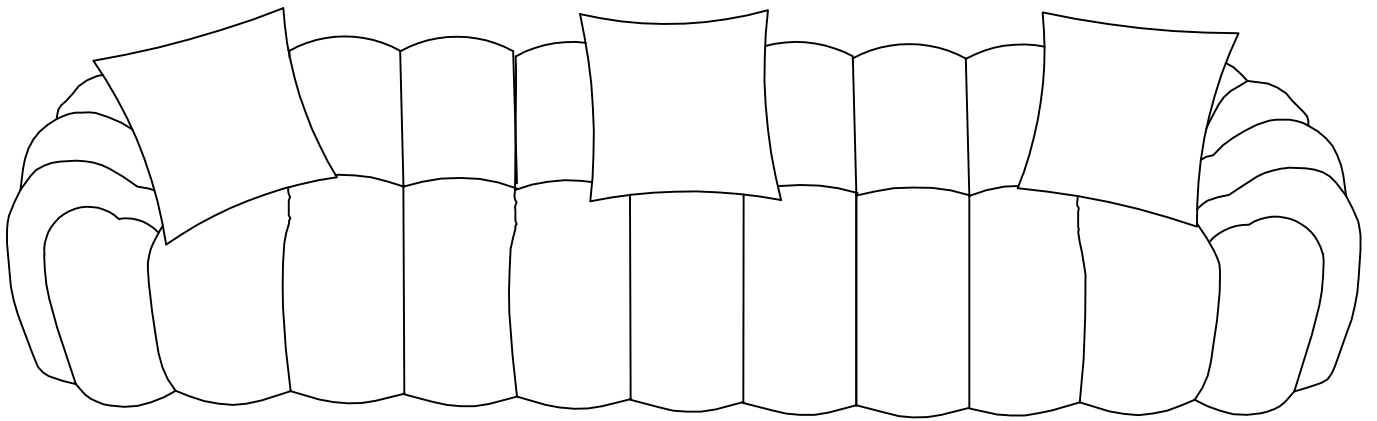

Ax1

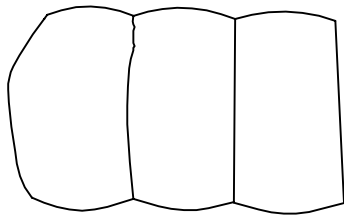

Bx3

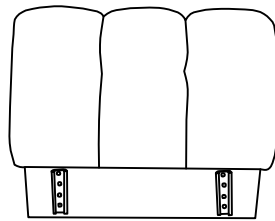

Cx3

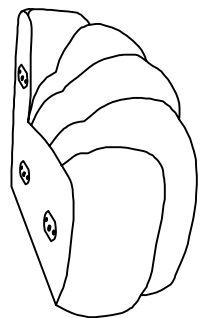

Dx1

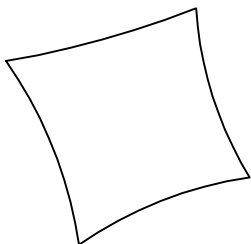

Ex3

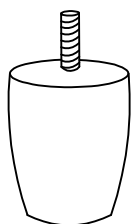

(1)x24



(2)x12

1

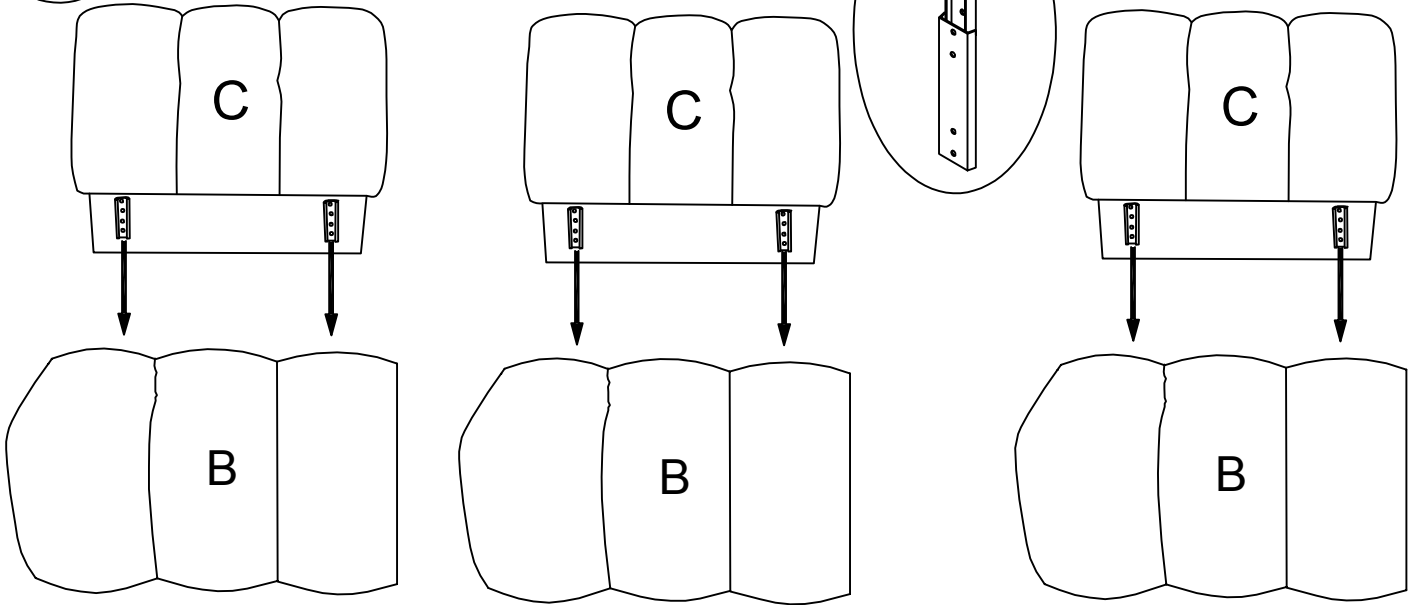

2

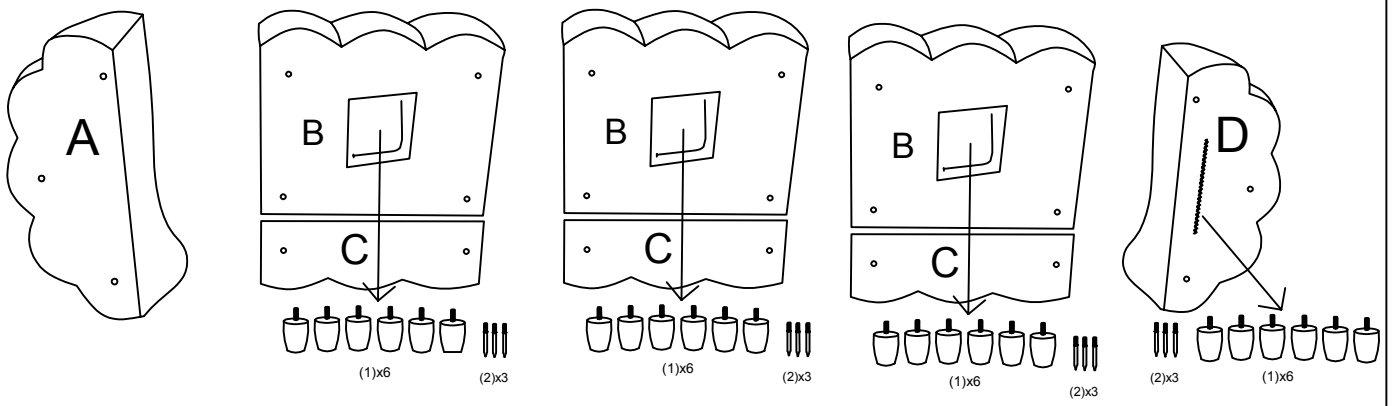

3

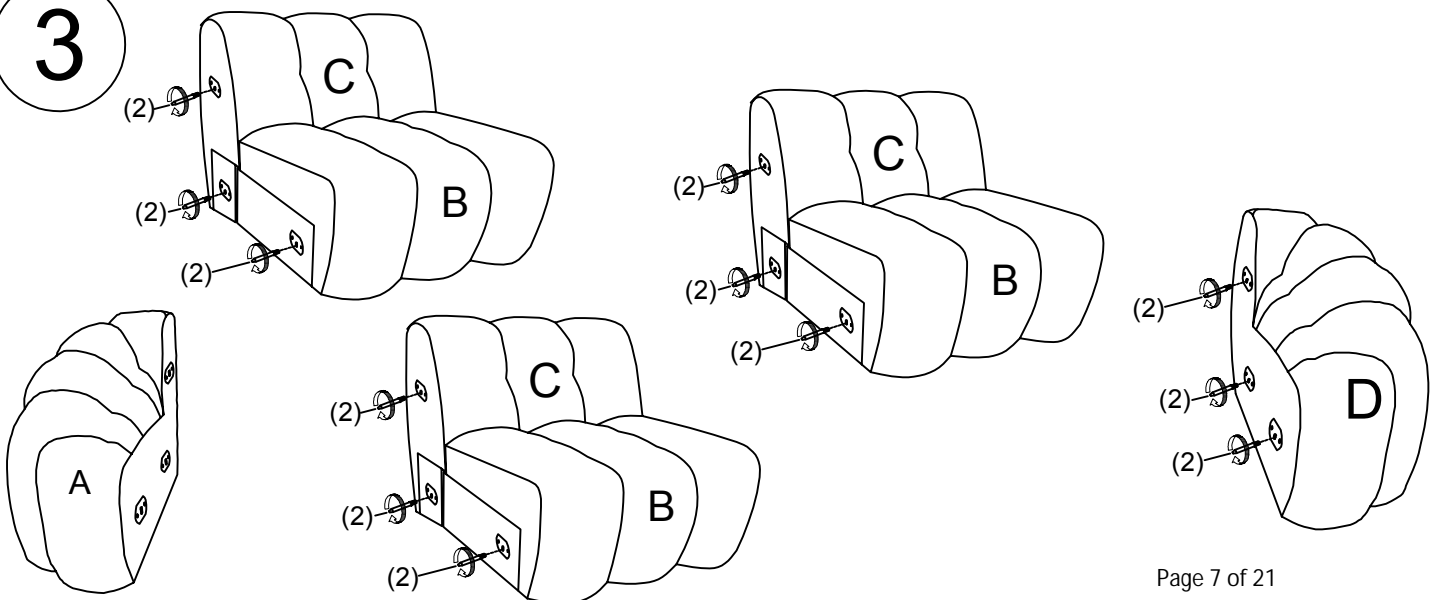

4

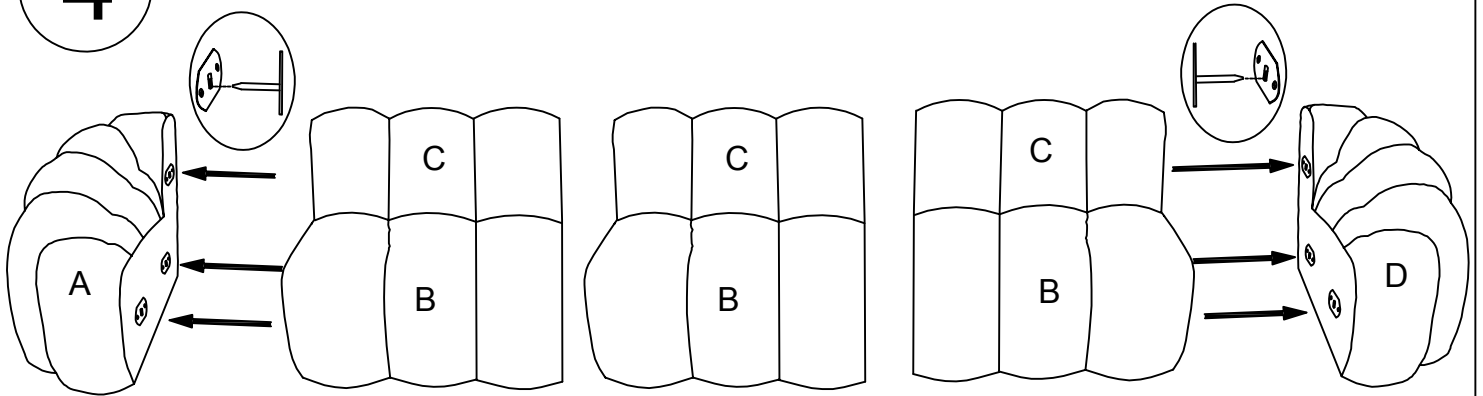

5

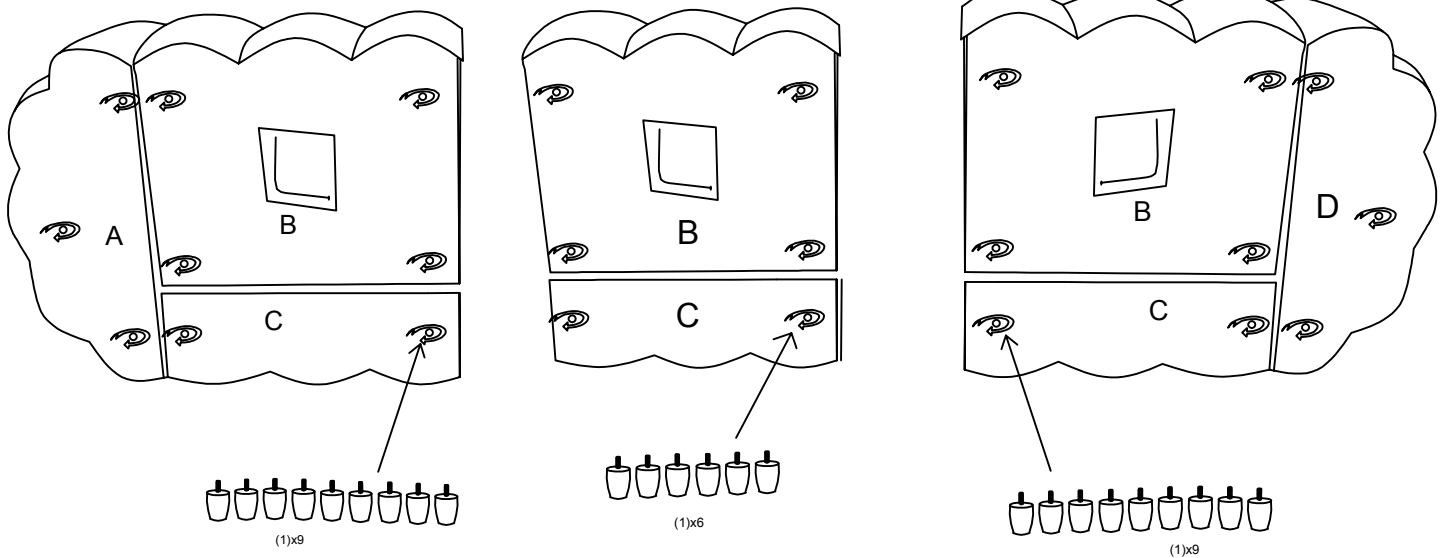

6

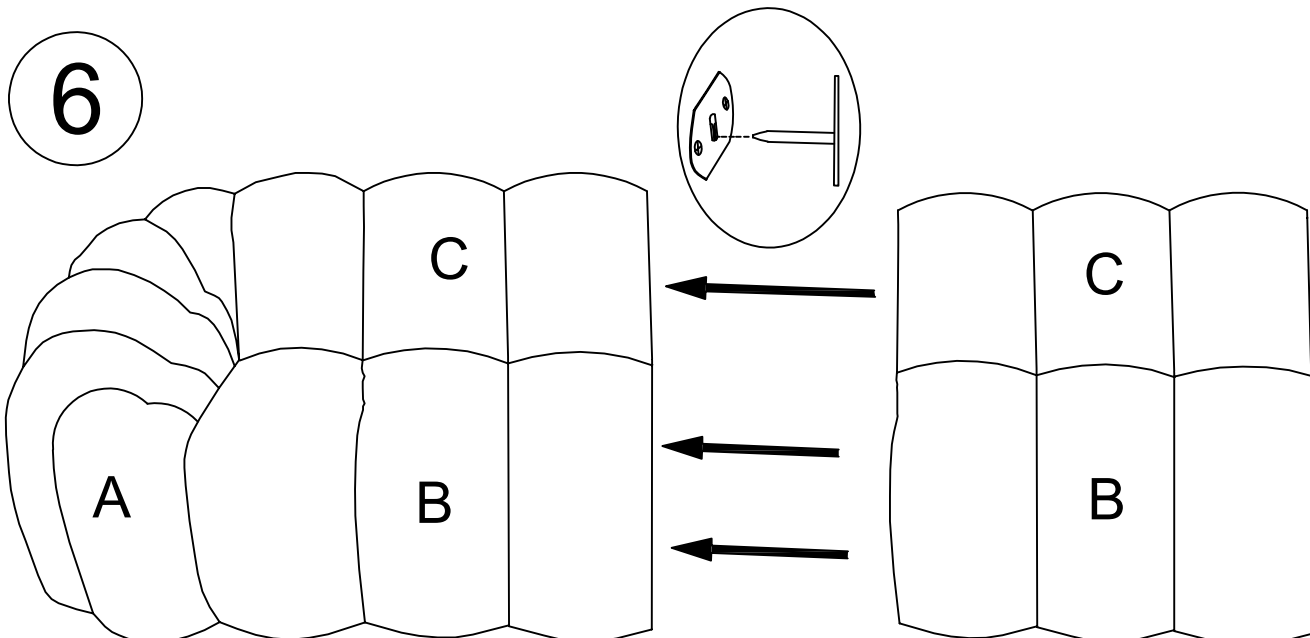

7

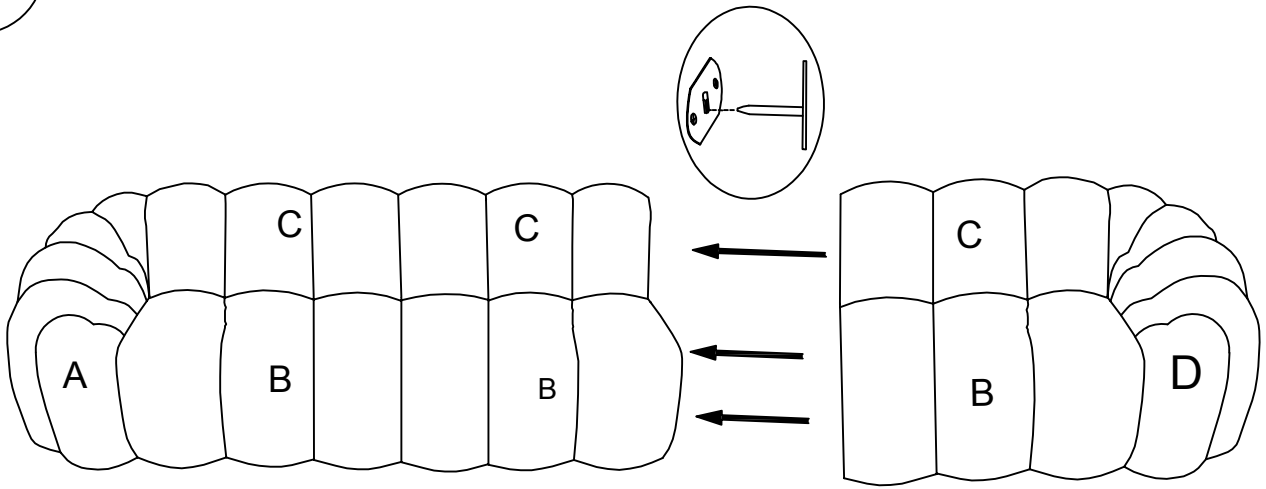

8

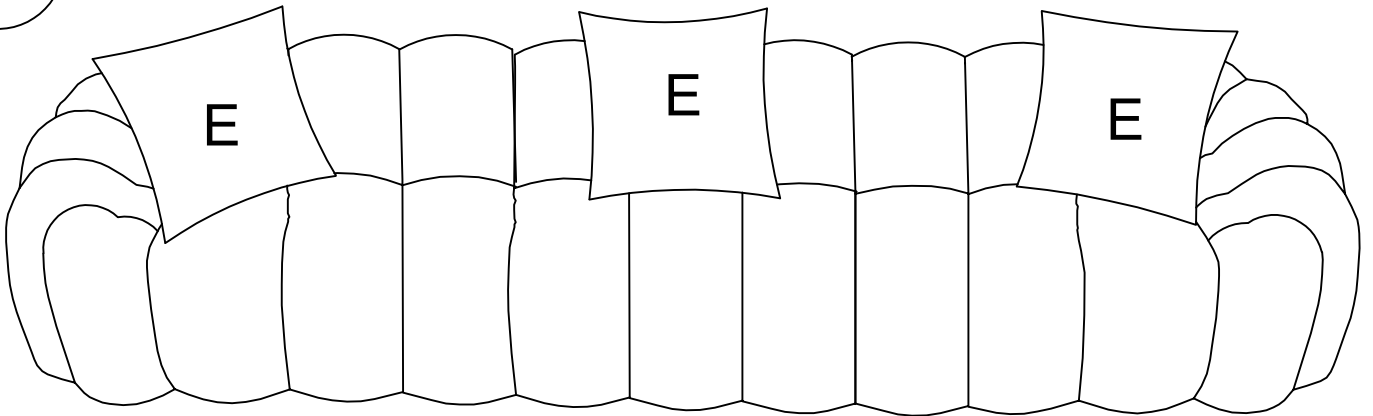

Option 3

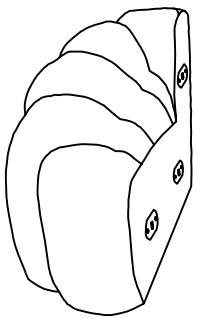
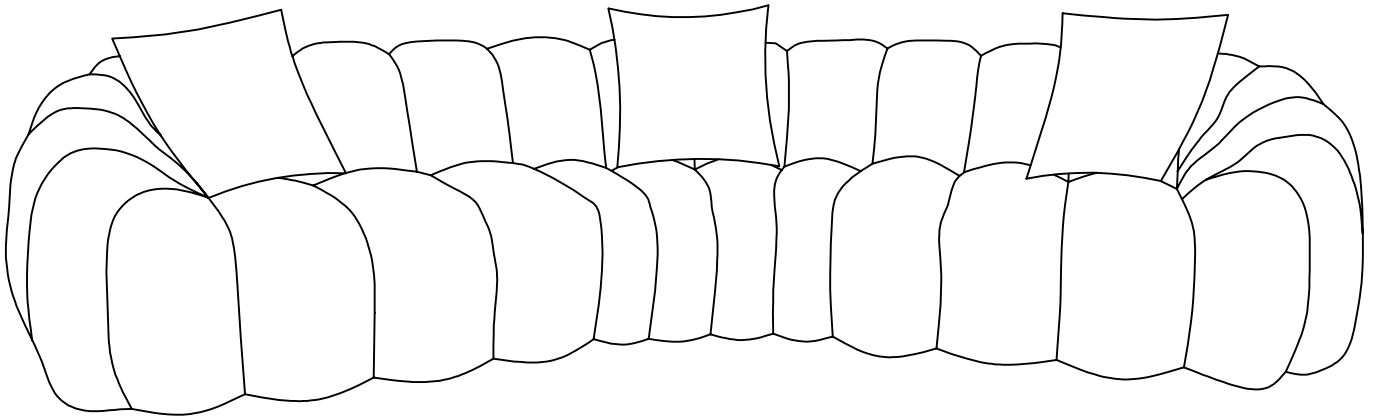
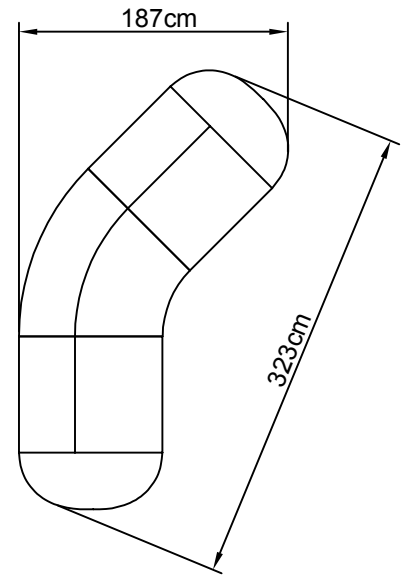

Ax1

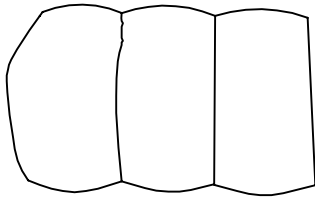

Bx2

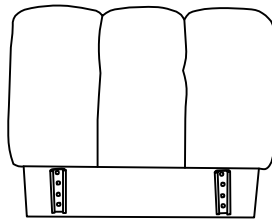

Cx2

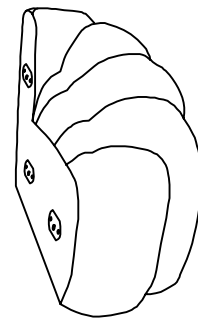

Dx1

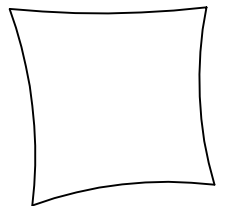

Ex3

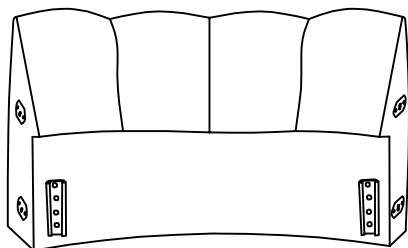

Fx1

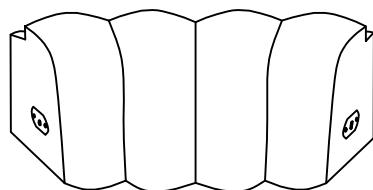

Gx1



(1)x24



(2)x12

1

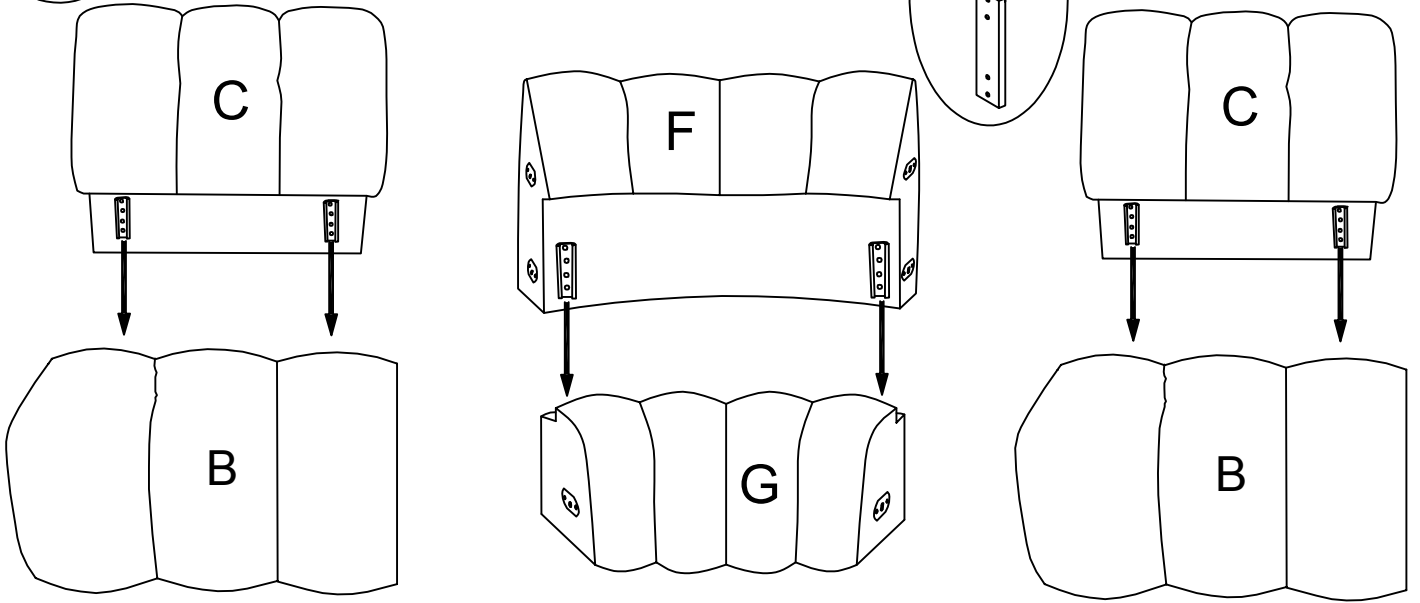

2

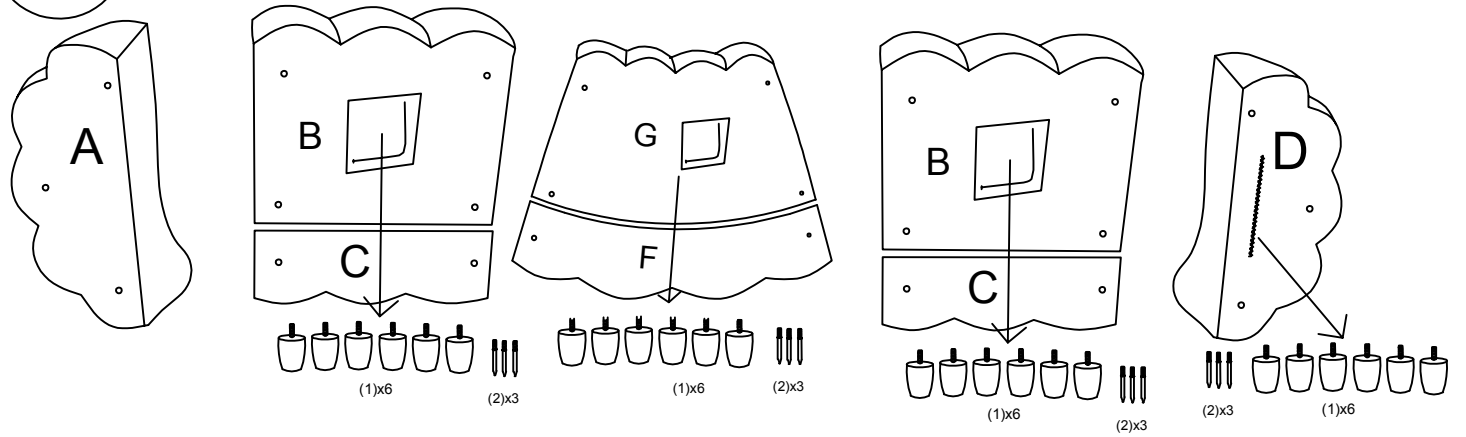

3

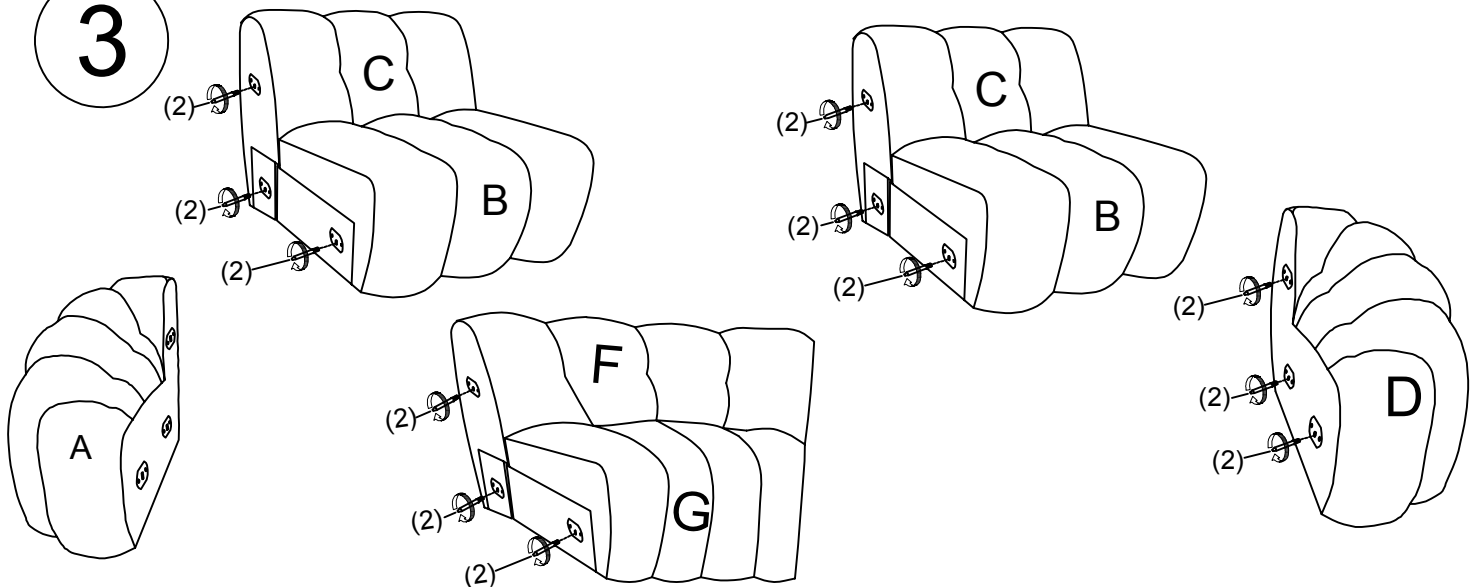

4

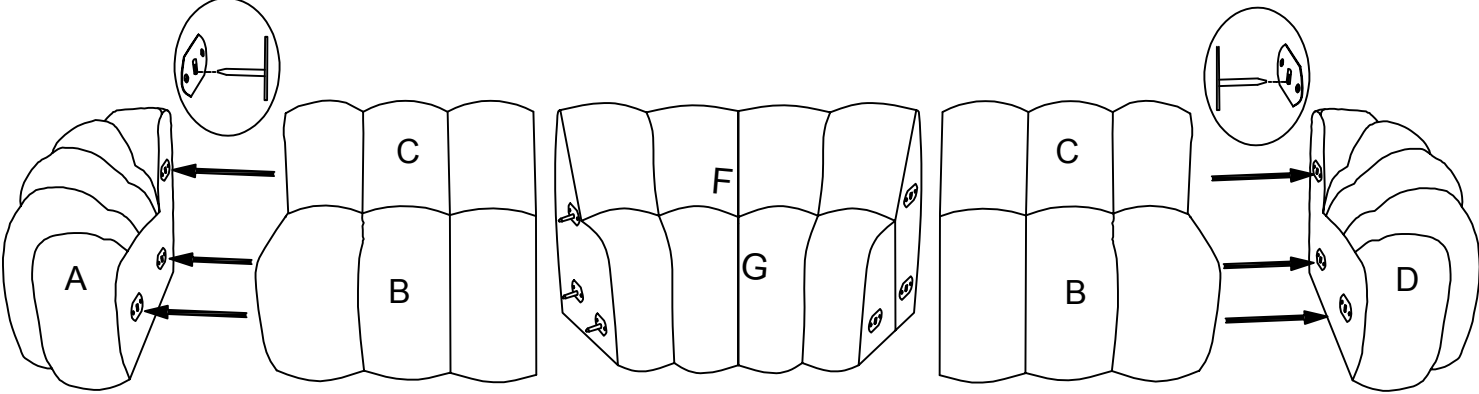

5

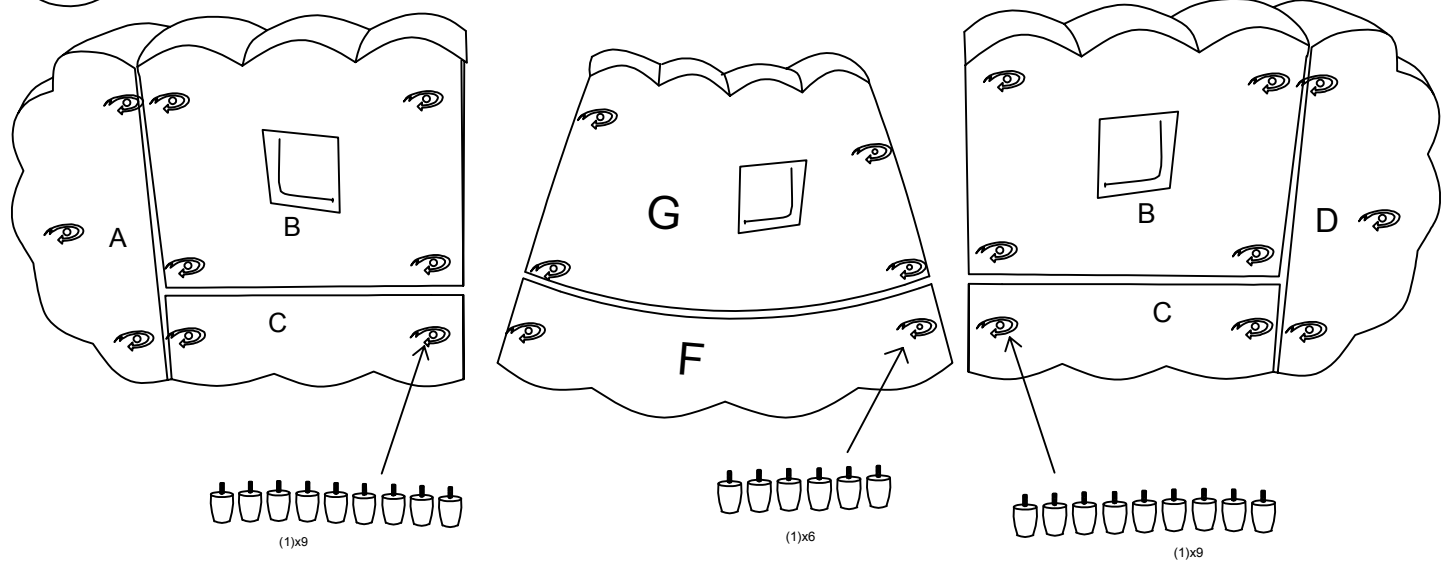

6

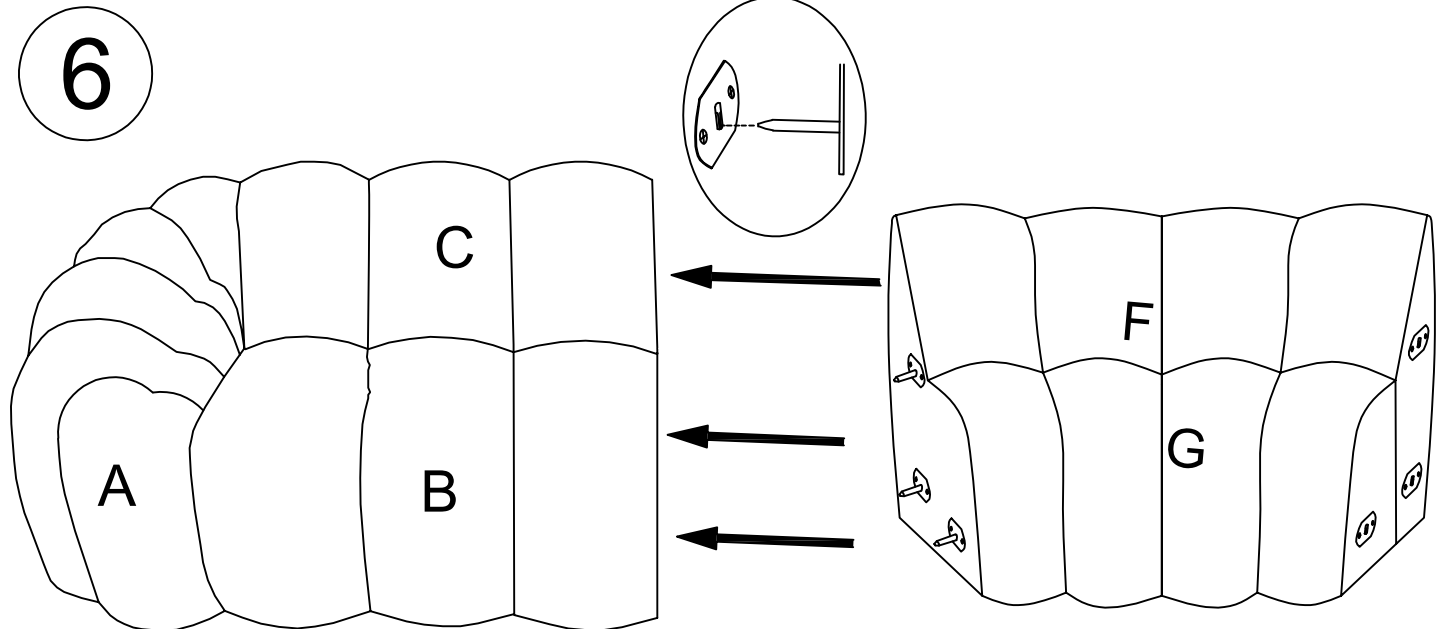

7

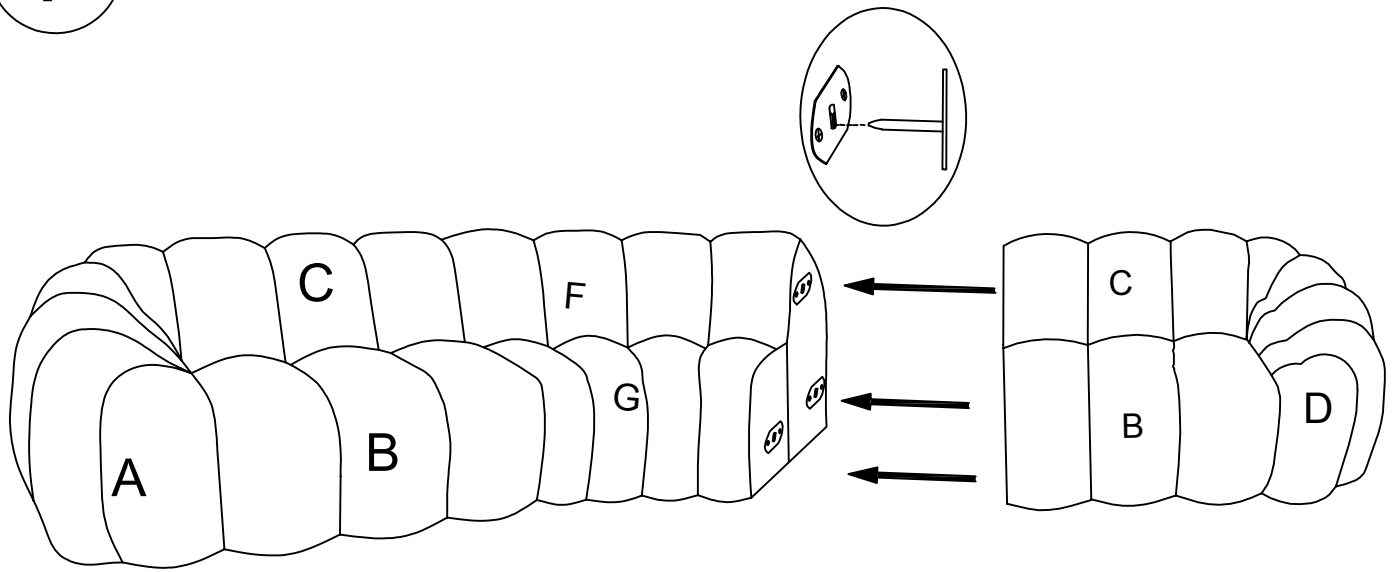

8

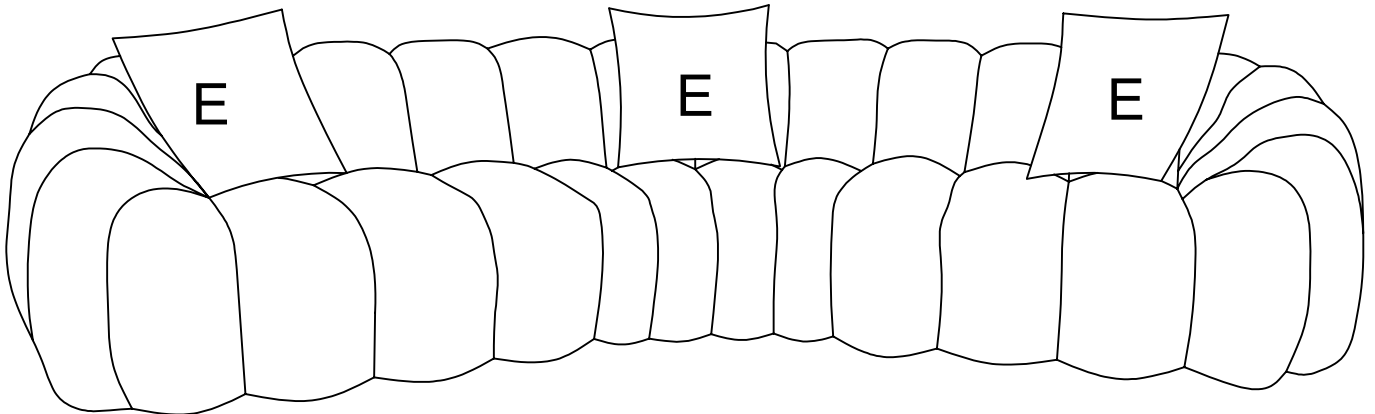

Option 4

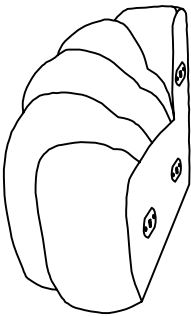
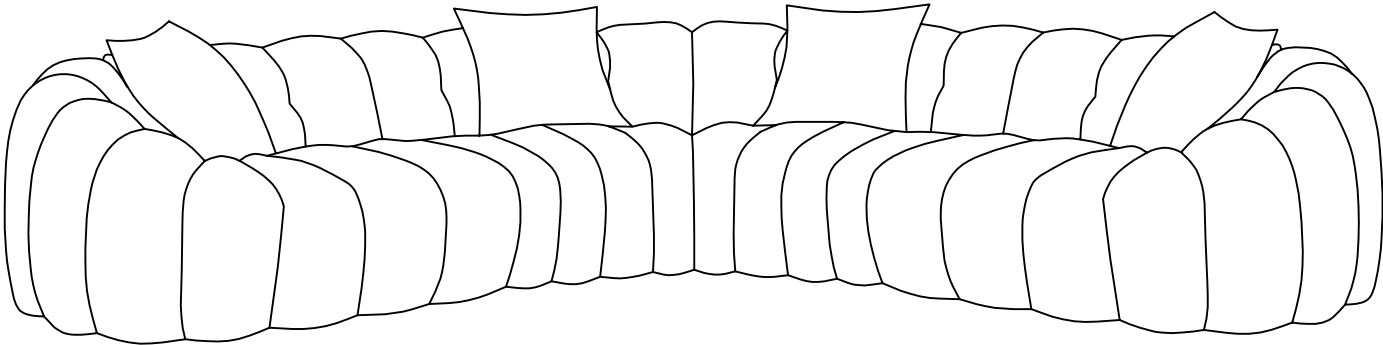
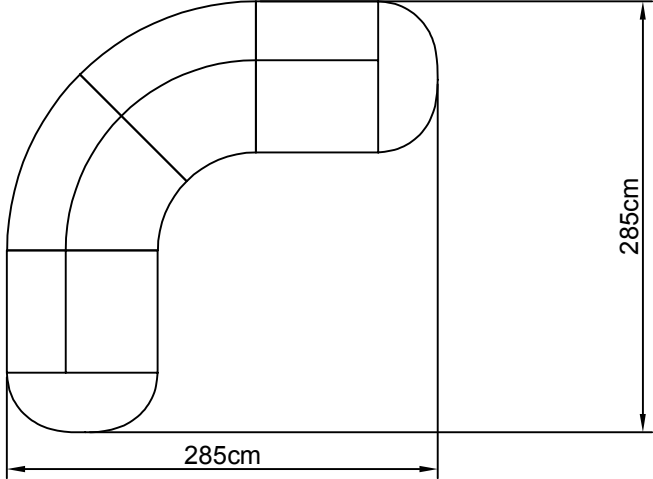

Ax1

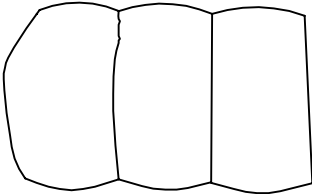

Bx2

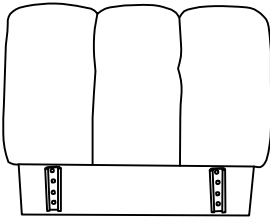

Cx2

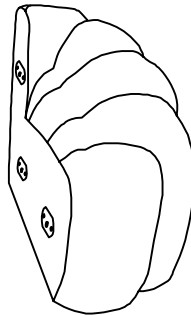

Dx1

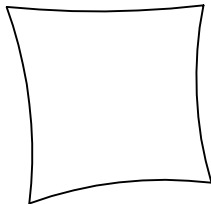

Ex4

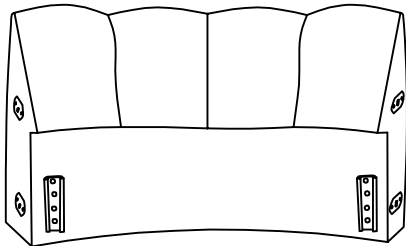

Fx2

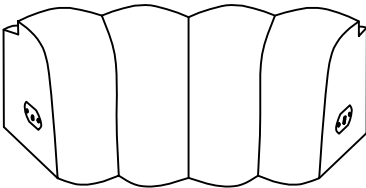

Gx2



(1)x30



(2)x15

1

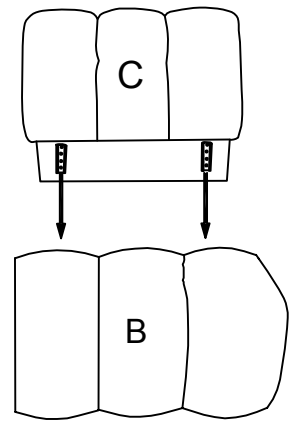
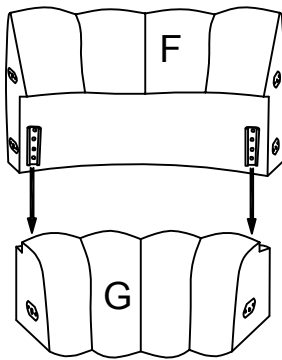
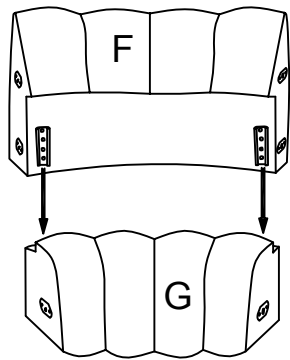
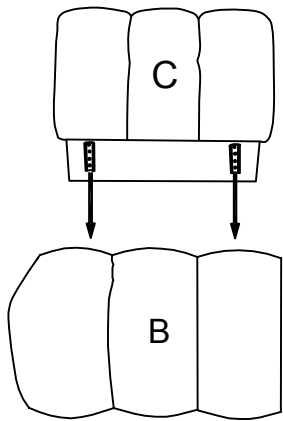
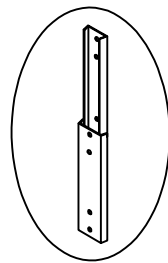

2

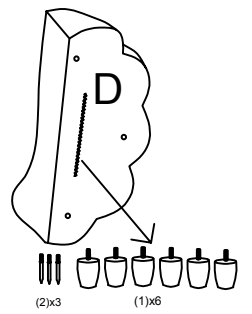
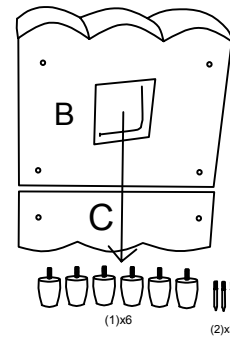
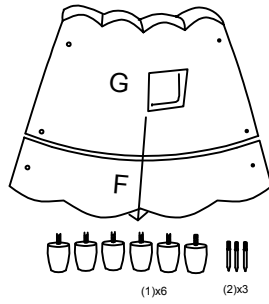
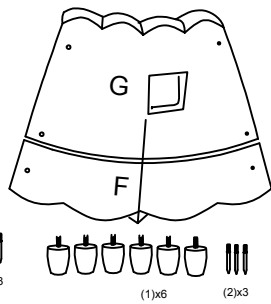
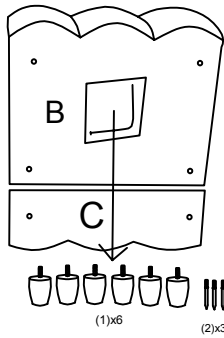
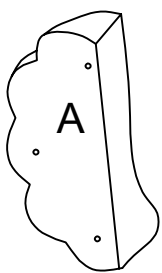

3

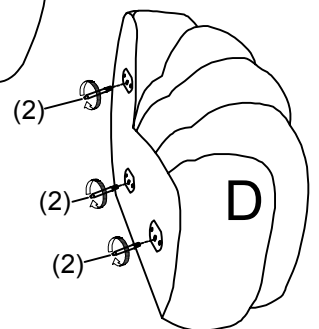
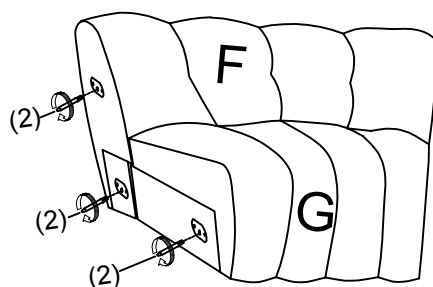
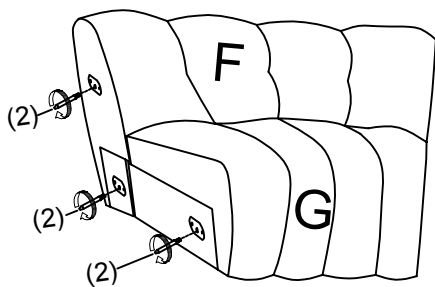
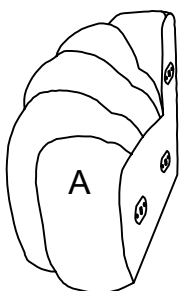
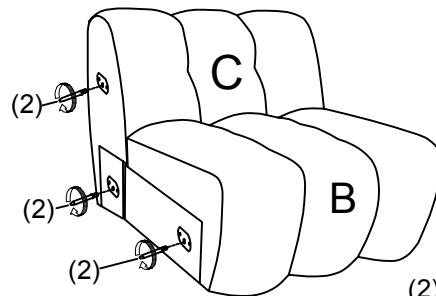
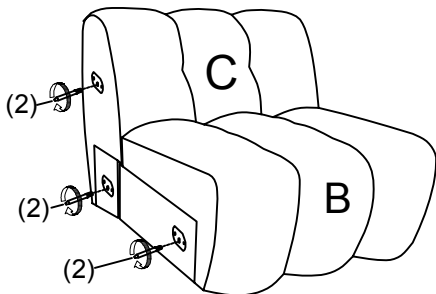

4

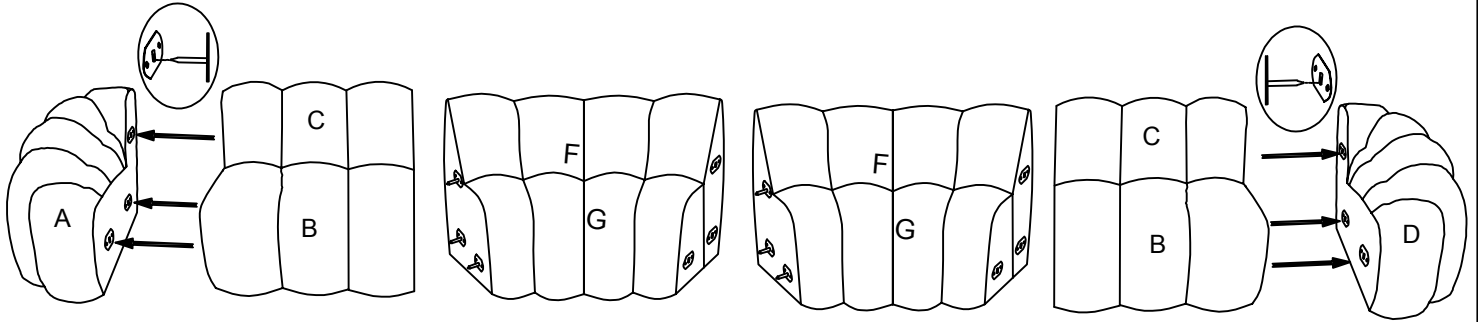

5

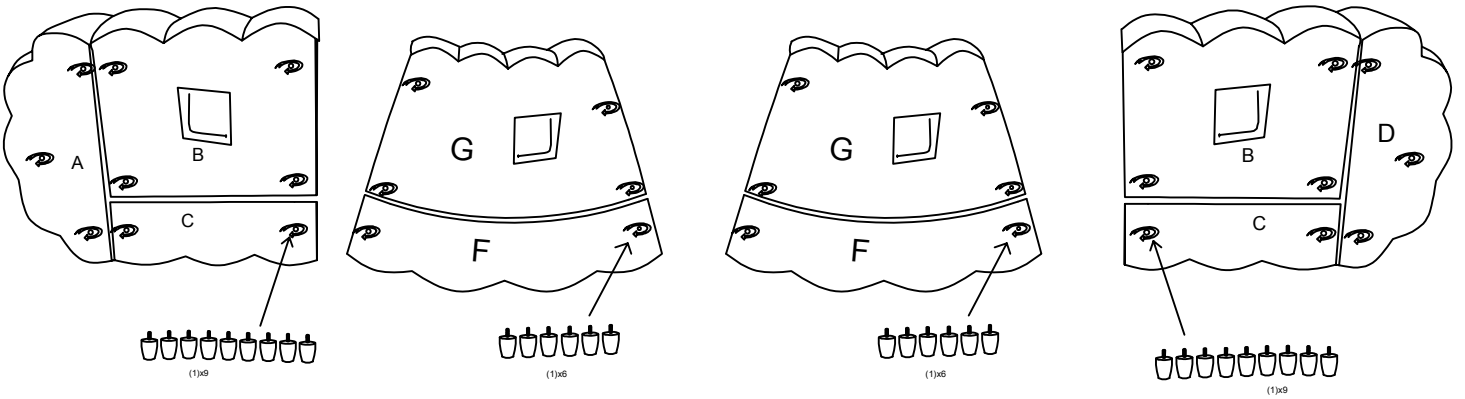

6

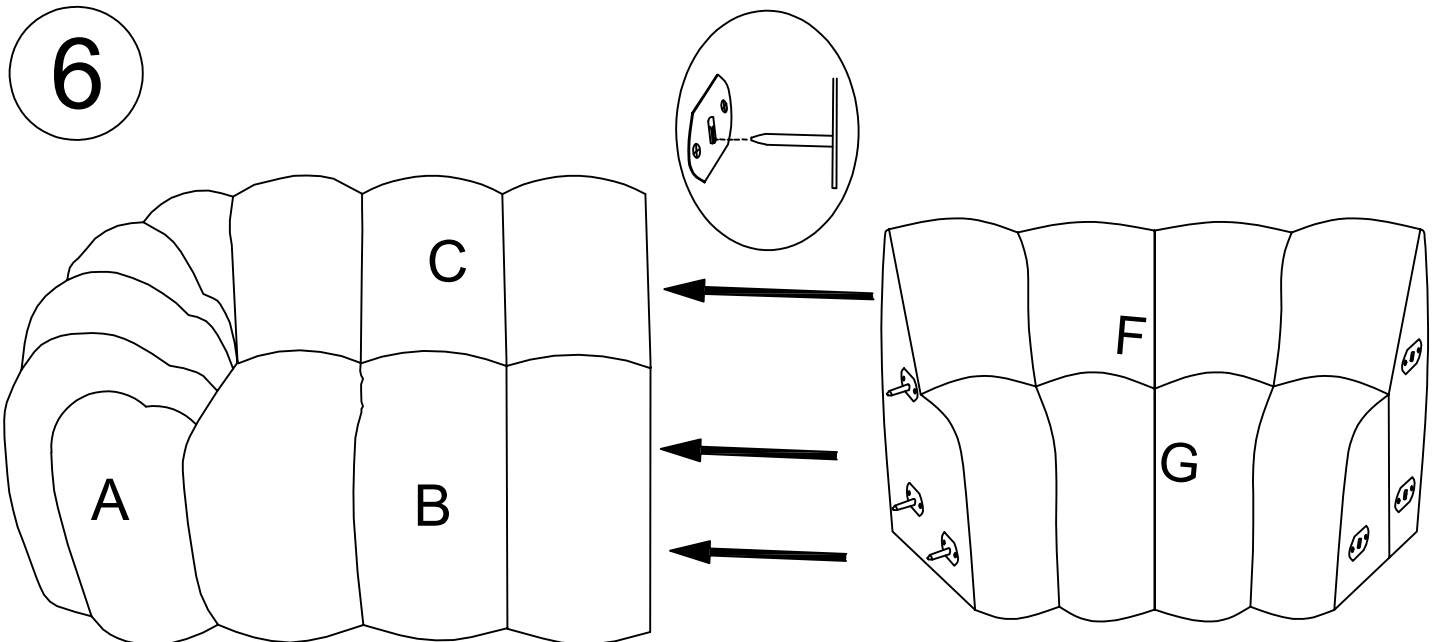

7

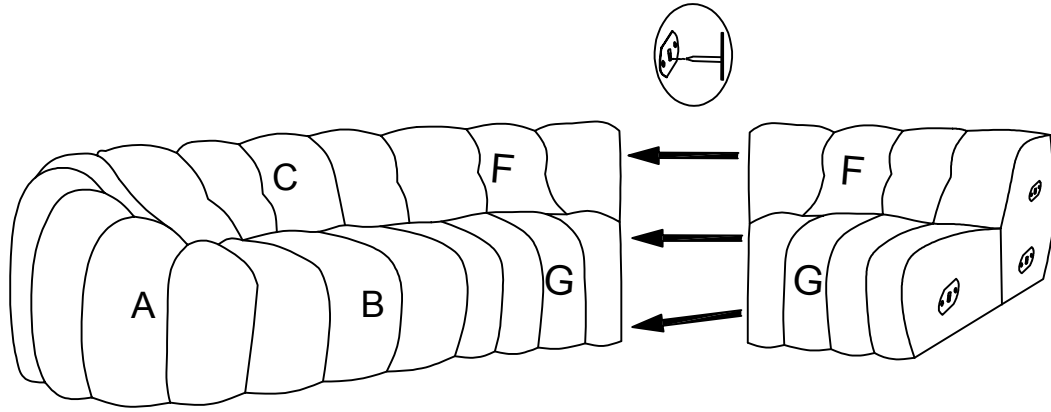

8

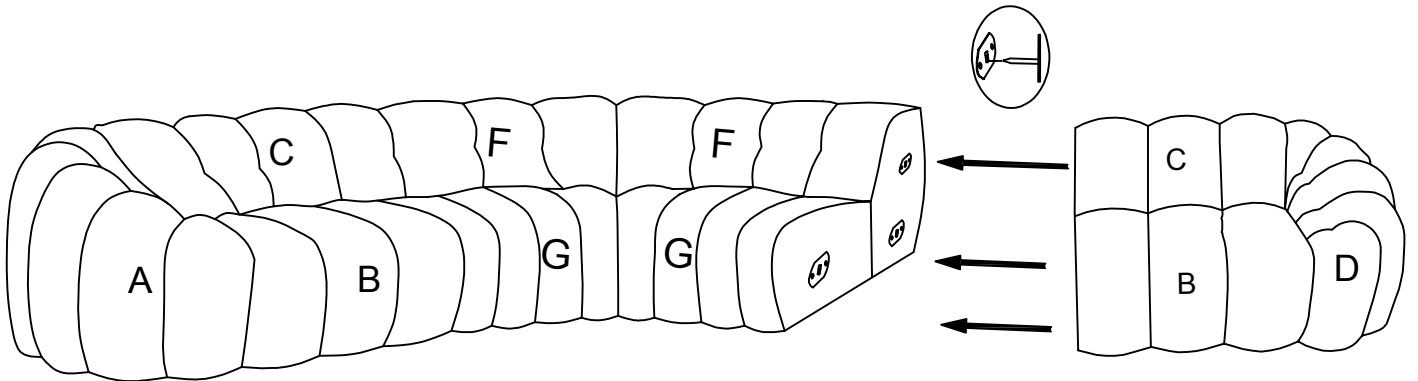

9

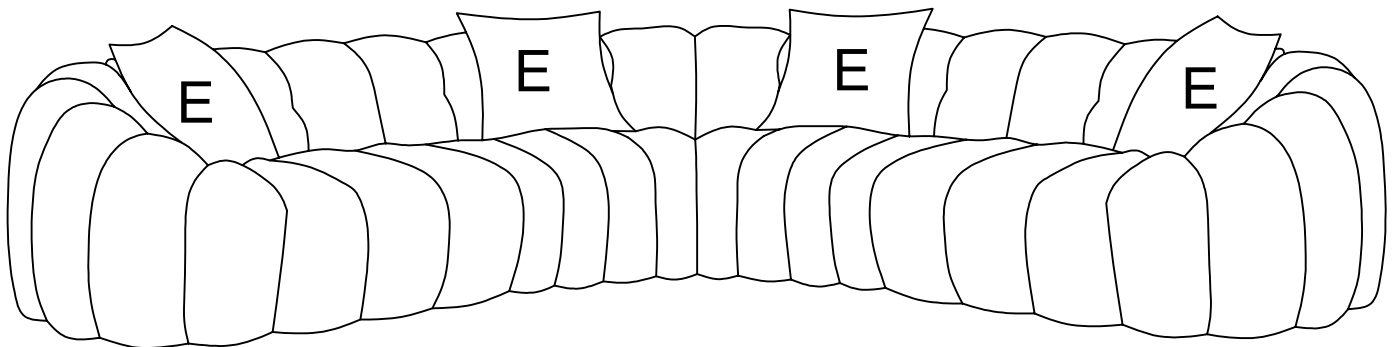

Option 5

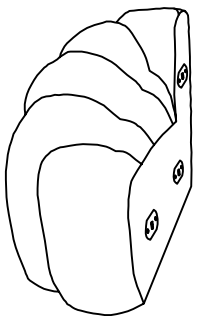
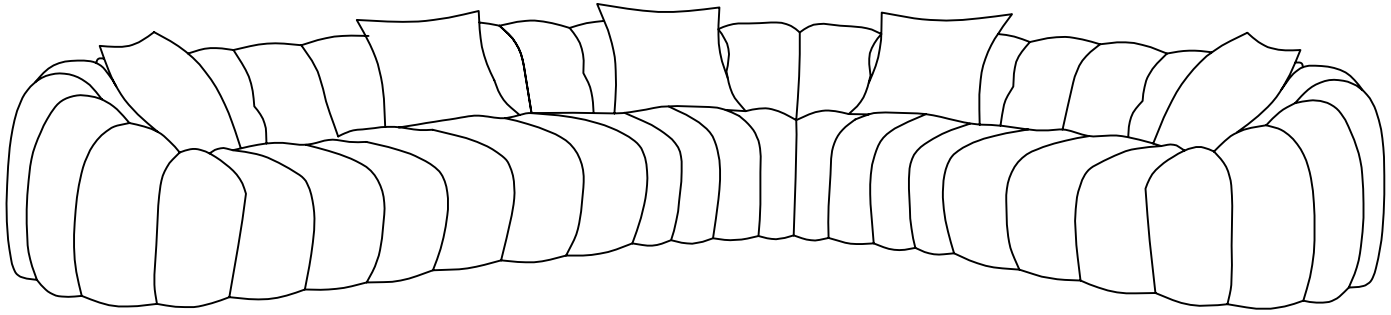
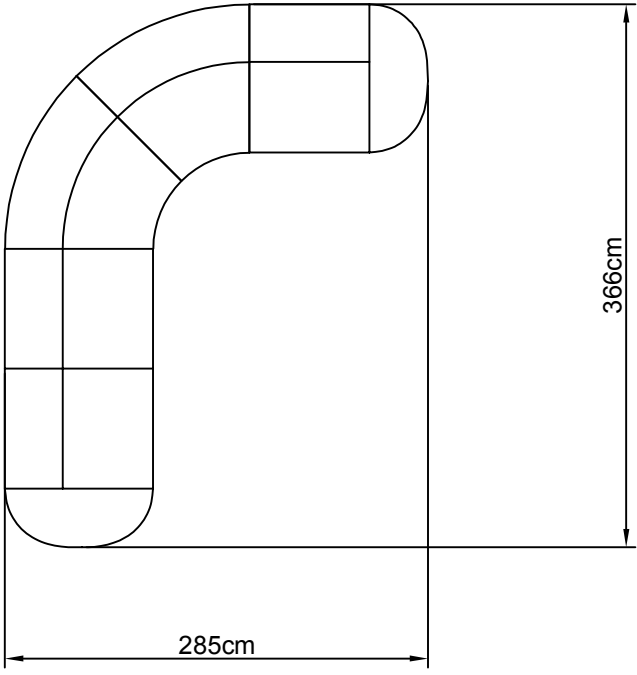

Ax1

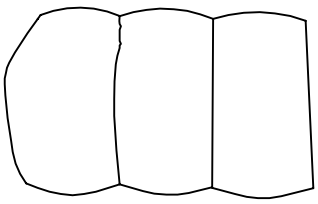

Bx3

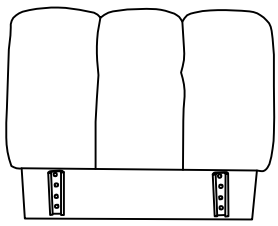

Cx3

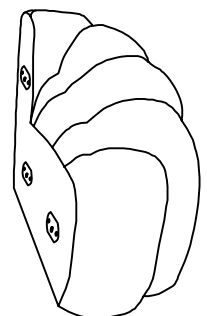

Dx1

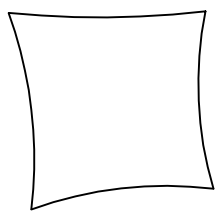

Ex5

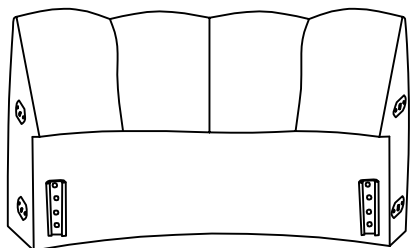

Fx2

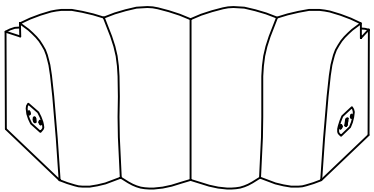

Gx2

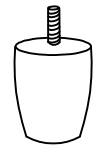

(1)x36

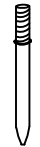

(2)x18

1

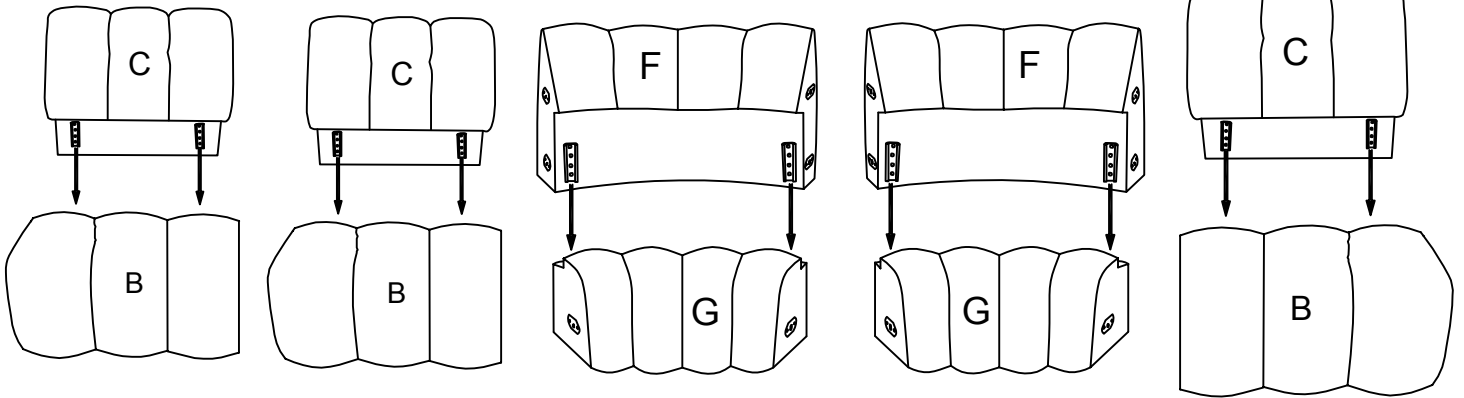
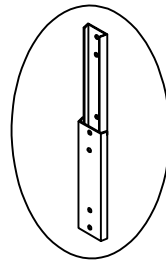

2

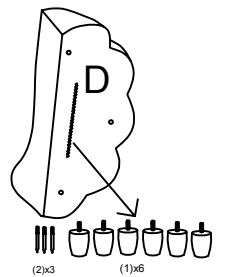
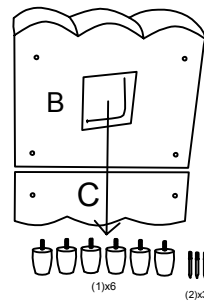
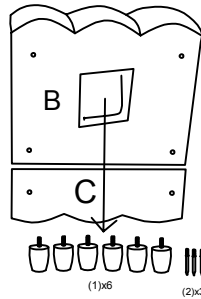
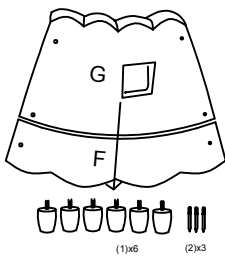
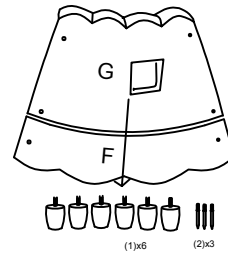
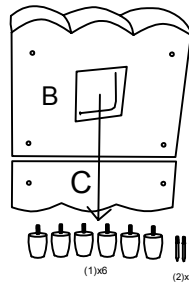
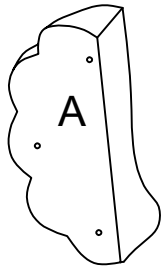

3

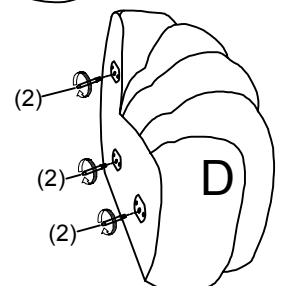
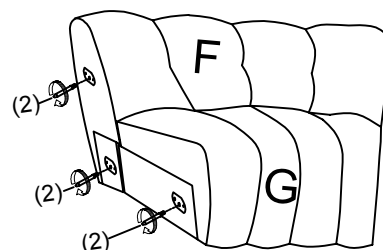
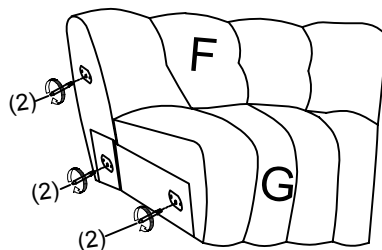
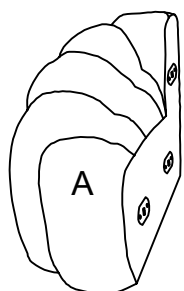
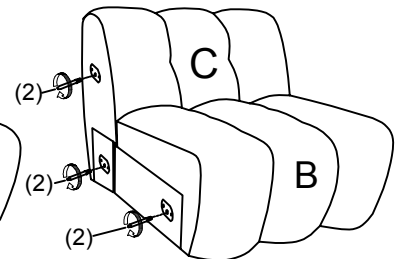
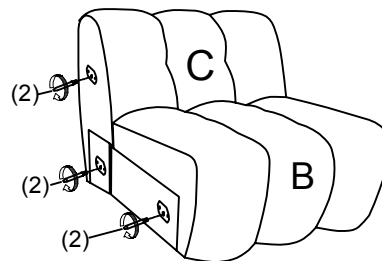
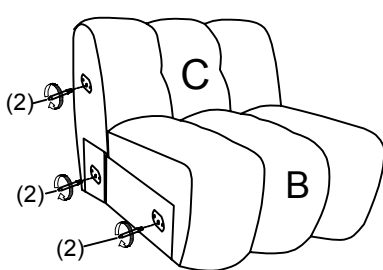

4

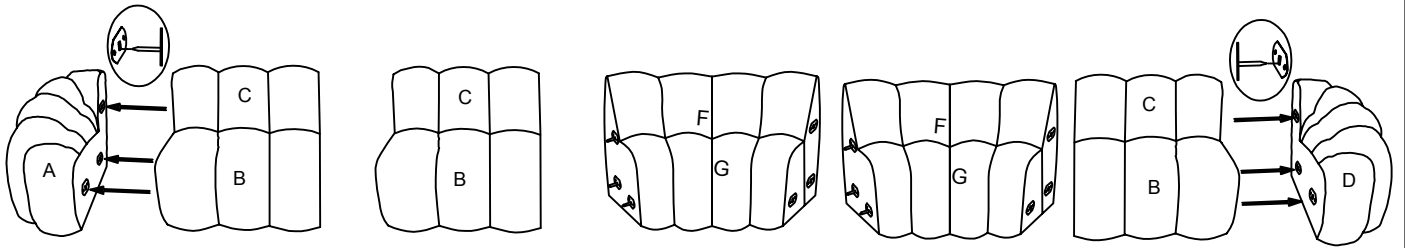

5

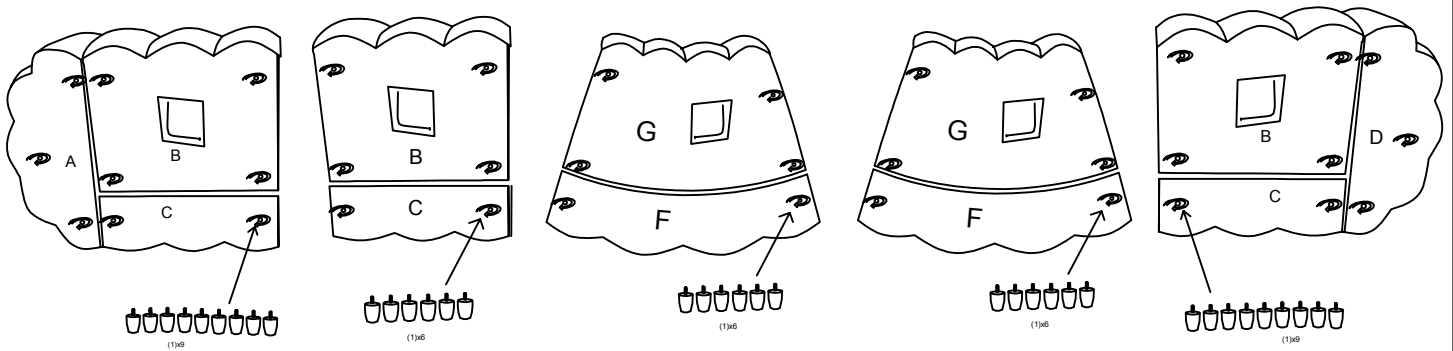

6

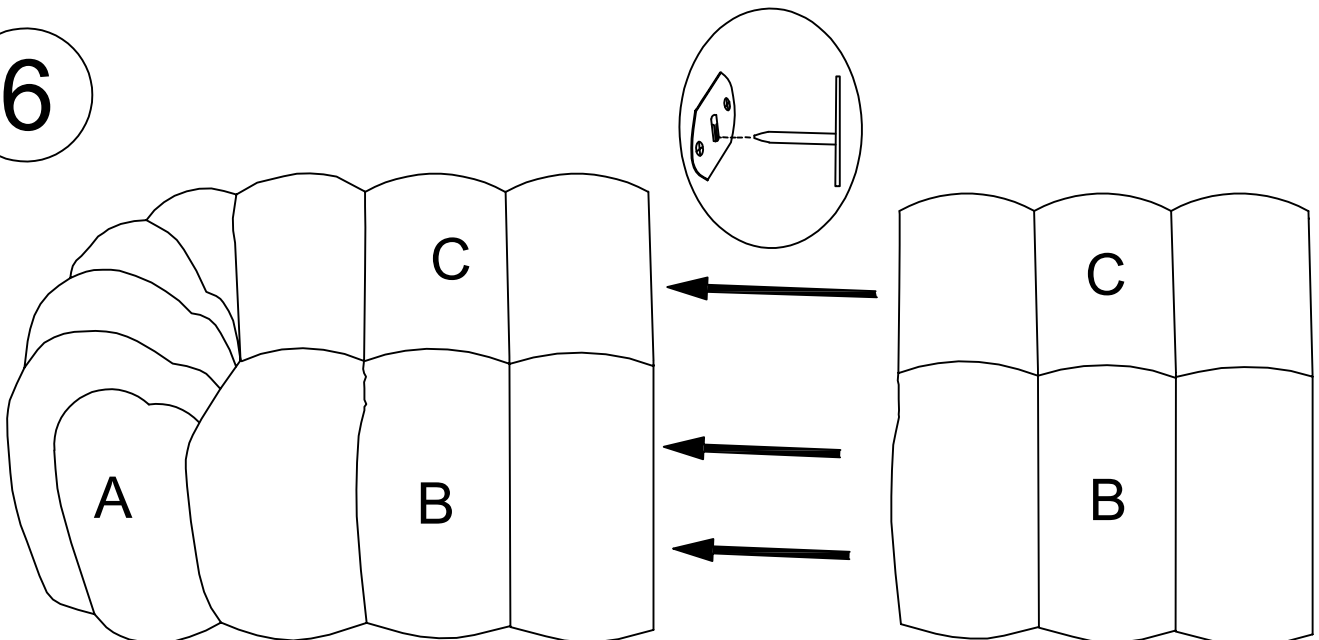

7

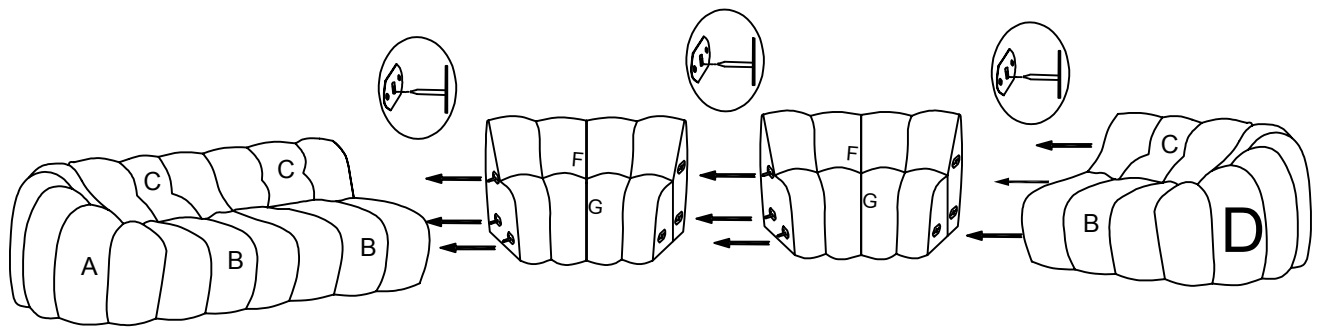

8

