

ASSEMBLY INSTRUCTION

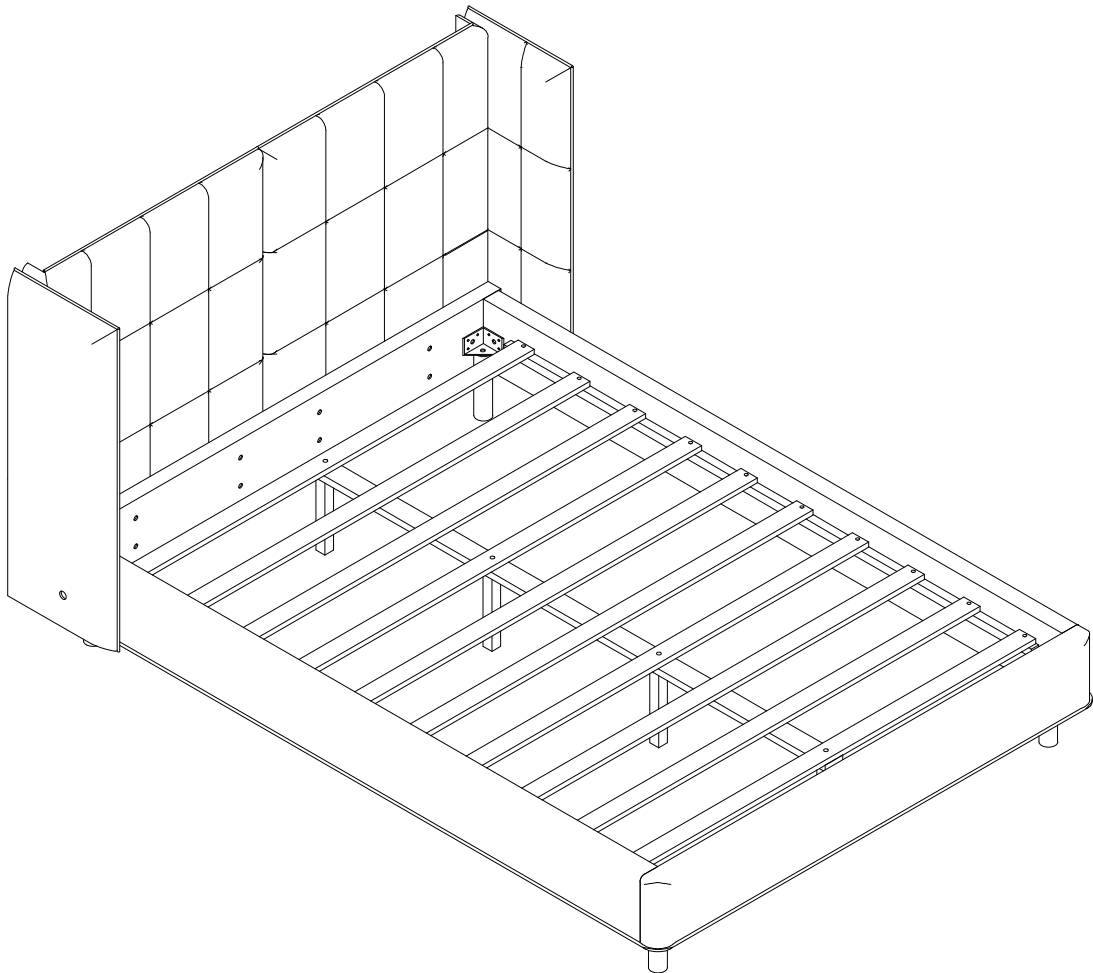

This set included 2 boxex if do not receive full 2 boxex. Please contact our customer service team

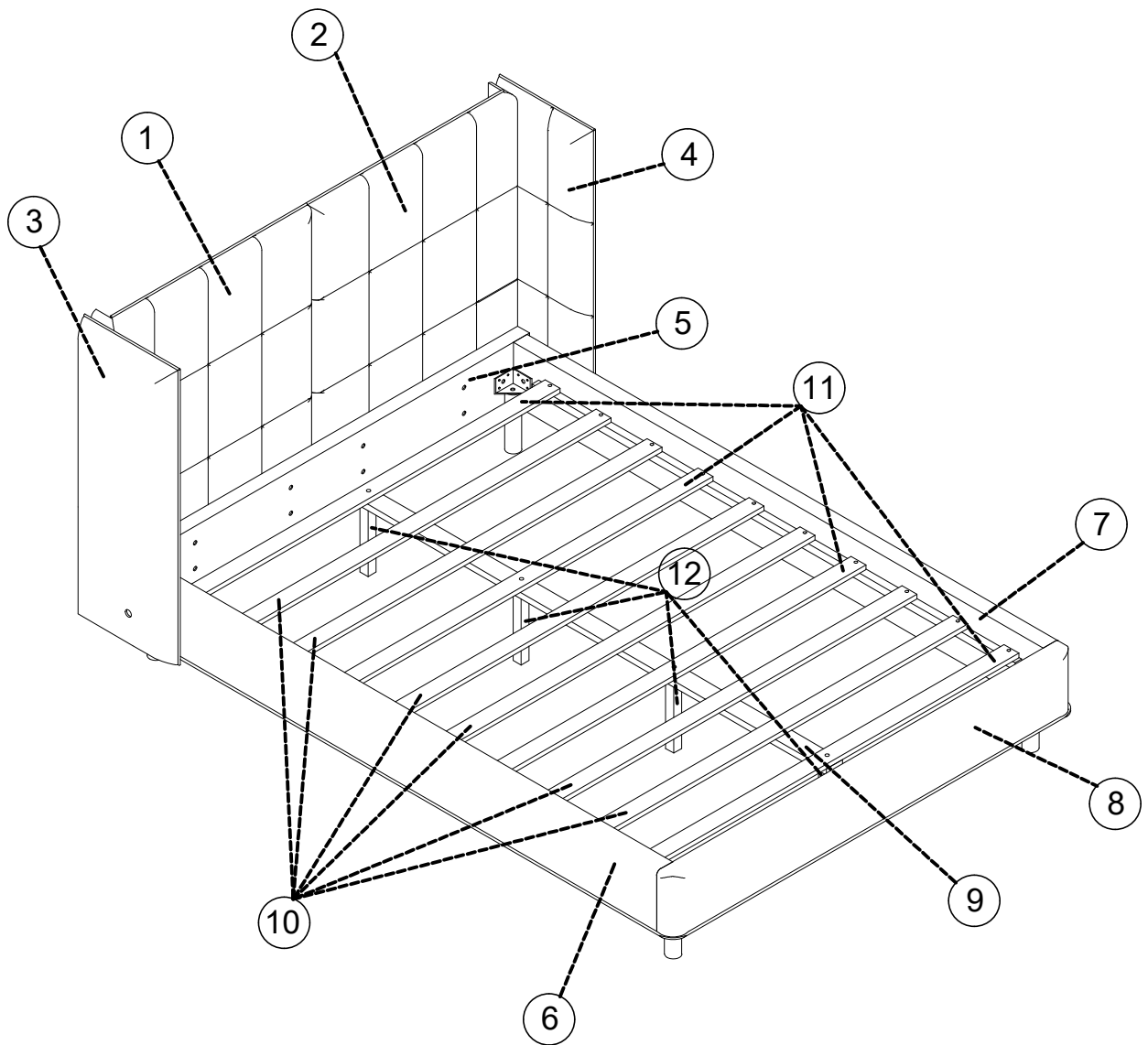



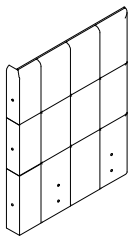
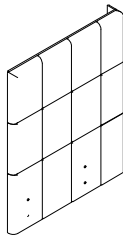

Part List

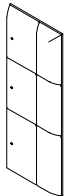
BOX 1/2:

<p>1</p>  <p>Head board Left -1pc</p>	<p>2</p>  <p>Head board Right -1pc</p>	<p>3</p>  <p>Wing board Left-1pc</p>
<p>4</p>  <p>Wing board Right-1pc</p>		

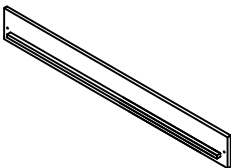
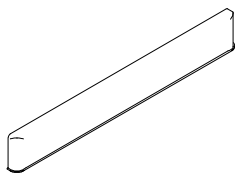
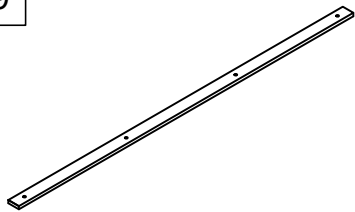
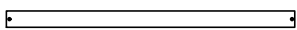
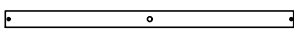
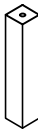
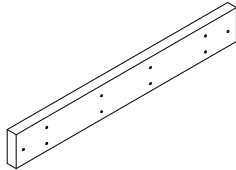
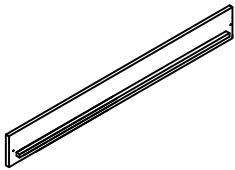









BOX 2/2:

<p>7</p>  <p>Side rail Right - 1pc</p>	<p>8</p>  <p>Footboard-1pc</p>	<p>9</p>  <p>Bed support Slates-1pc</p>
<p>10</p>  <p>Slates-6pcs</p>	<p>11</p>  <p>Slates-4pcs</p>	<p>12</p>  <p>Legs middle-4pcs</p>
<p>5</p>  <p>Head board below-1pc</p>	<p>6</p>  <p>Side rail Left - 1pc</p>	<p>Hardware</p> 



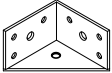
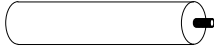

HARDWARE

Check that you've received all hardware listed below.

Hardware List

No.	OUTLOOK	DESC	QTY
(A)		Bolts 5/16"x38 mm	16
(B)		Plain washer Ø5/16"x19x1.5 mm	20
(C)		Spring washer Ø5/16"x12 mm	20
(D)		Allen key 80x30x4 mm	1
(E)		Bolts 5/16"x45 mm	4
(F)		Bolts 1/4"x20 mm	8
(G)		Plain washer Ø1/4"x19x1.5 mm	8
(H)		Spring washer Ø1/4"x10 mm	8
(I)		Screws Ø4x20 mm	24
(K)		Screws Ø4x30 mm	20
(L)		Metal bas	4
(M)		Legs	4

STEP 1

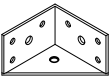

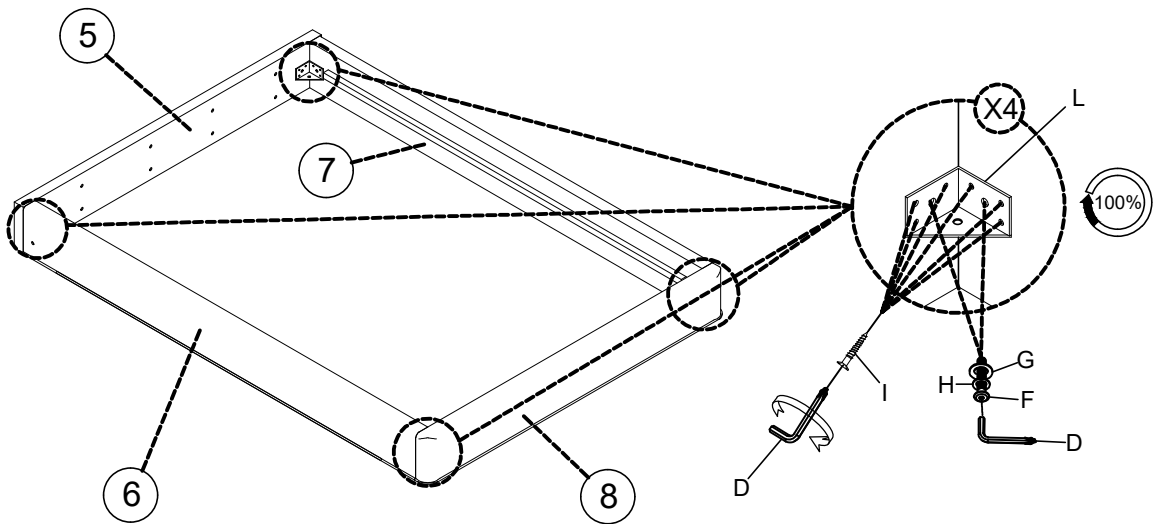

F x 8 	G x 8 	H x 8 	D x 1 	I x 24 	L x 4 
--	--	--	---	---	--

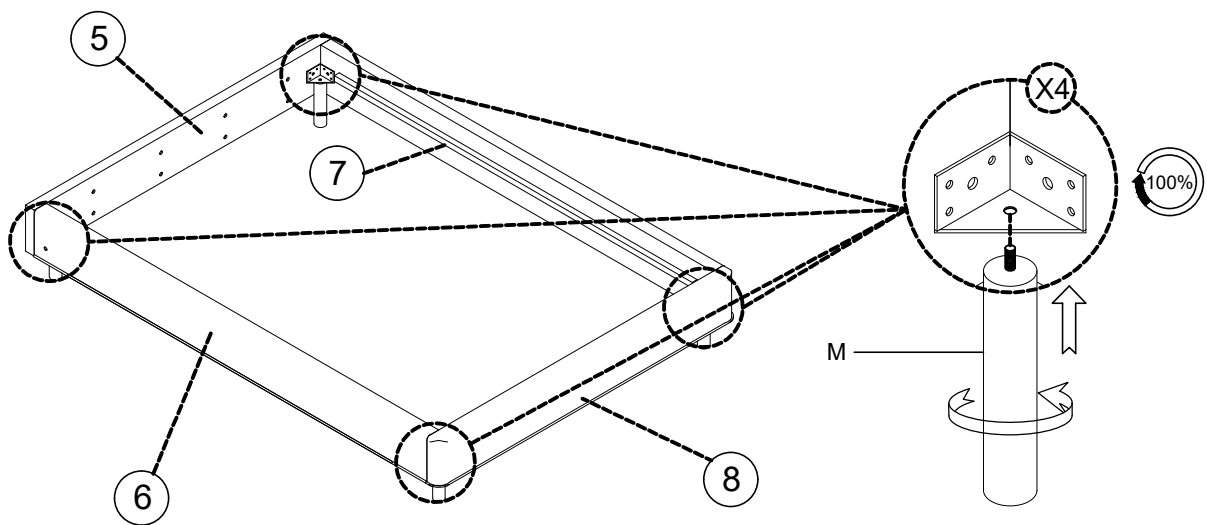
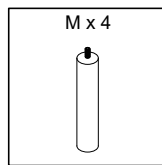

STEP 2





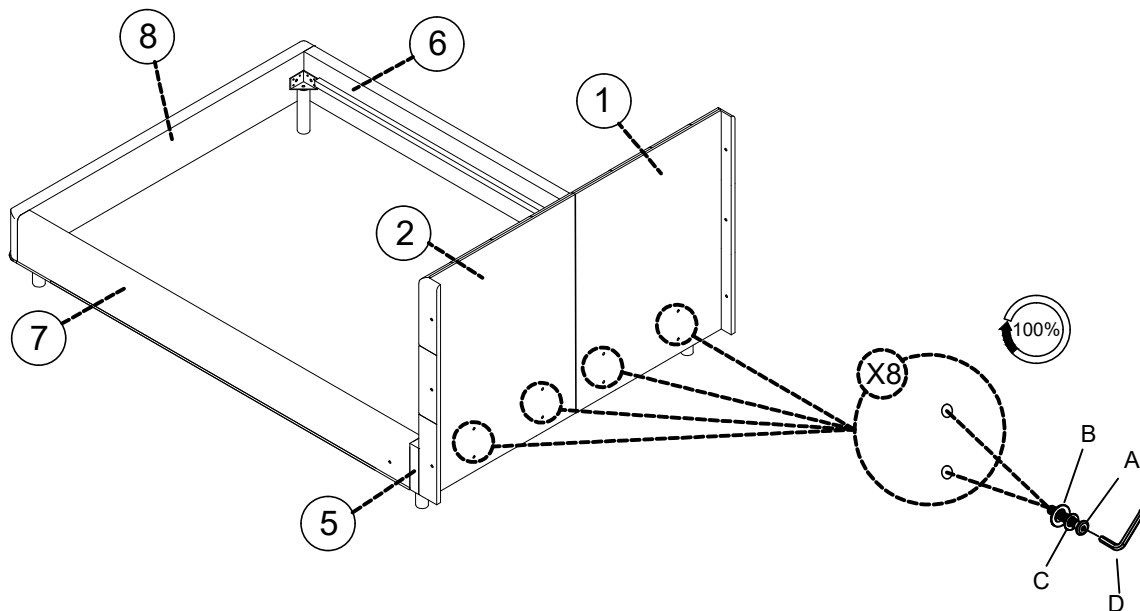

STEP 3

A x 8	B x 8	C x 8	D x 1
			





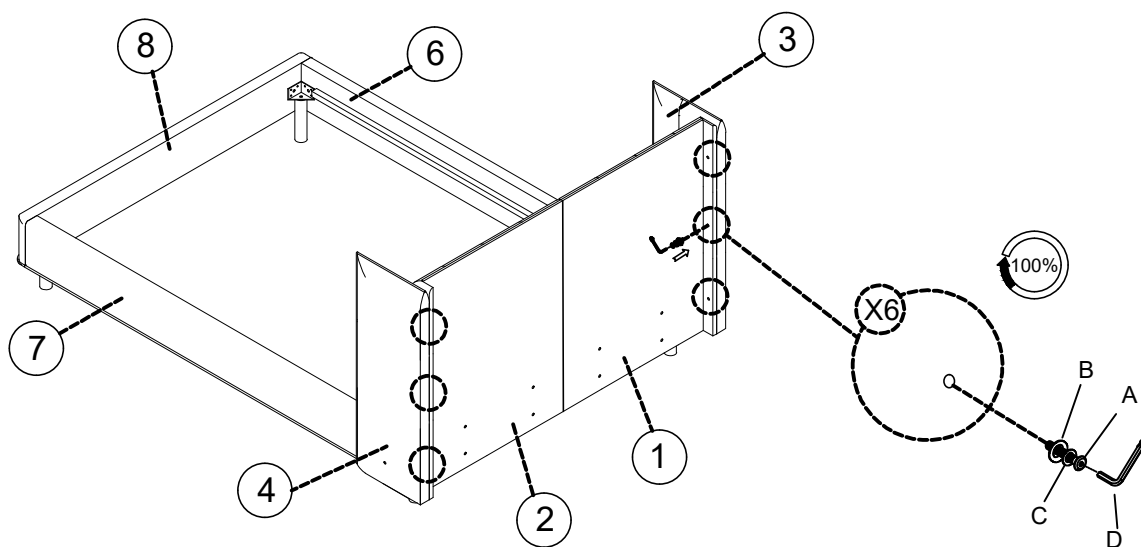

STEP 4

A x 6	B x 6	C x 6	D x 1
			





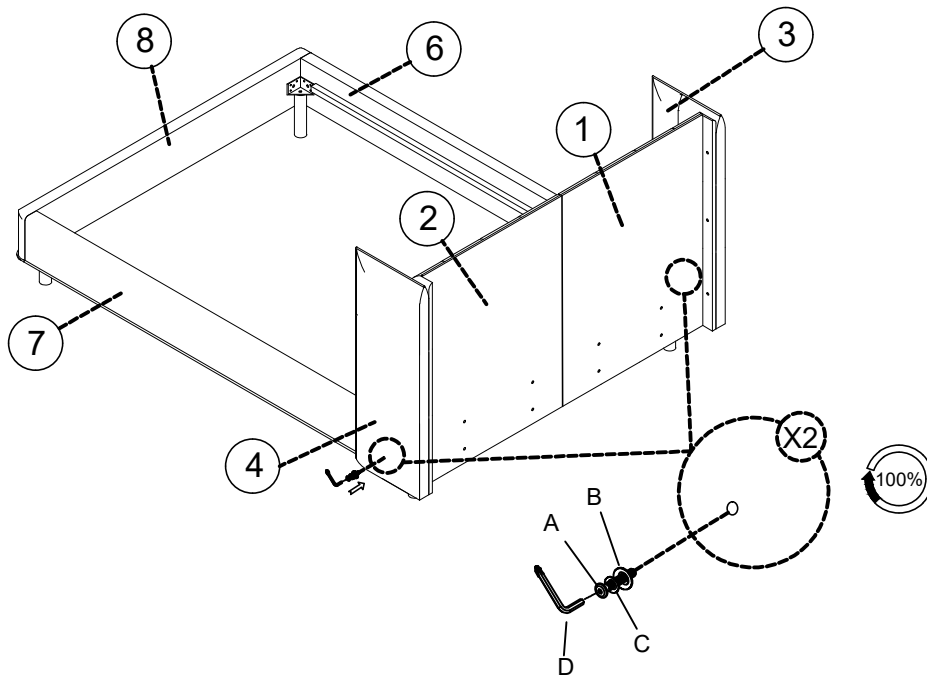

STEP 5

A x 2	B x 2	C x 2	D x 1
			



STEP 6

E x 4	B x 4	C x 4	D x 1
			

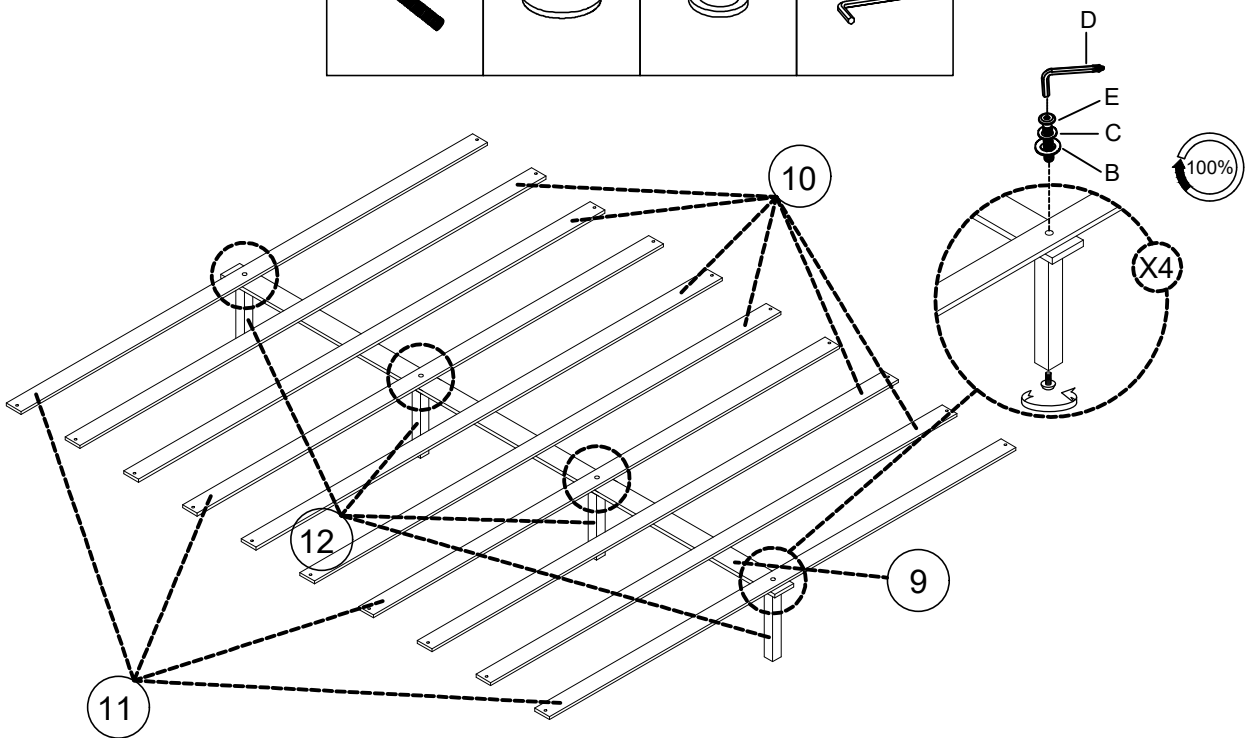

STEP 7

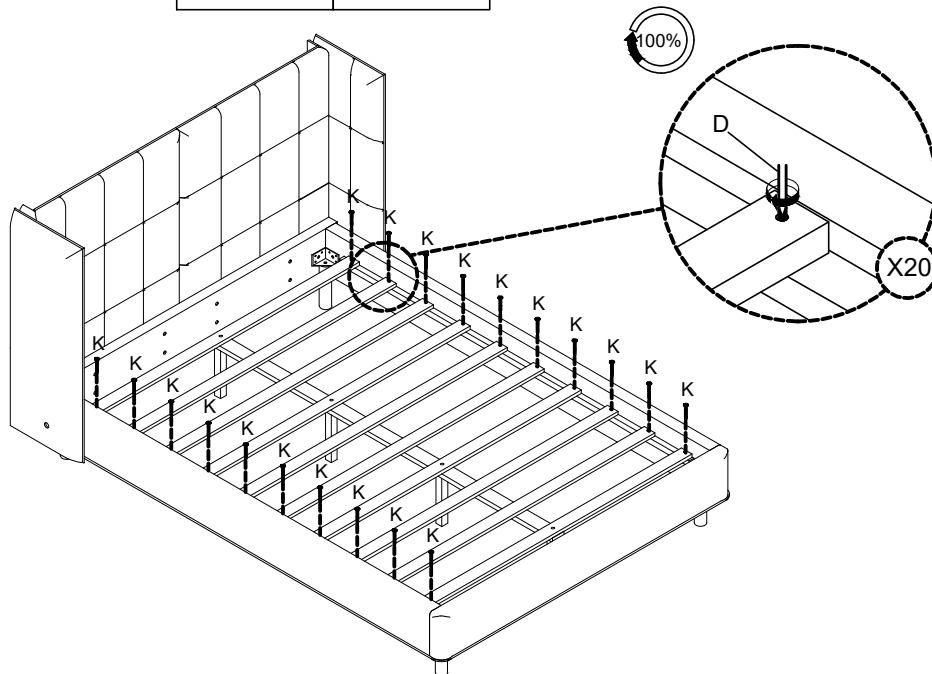
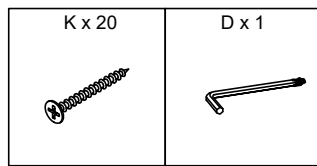

COMPLETE

