

## Pull the kitchen basin faucet

### Installation instruction

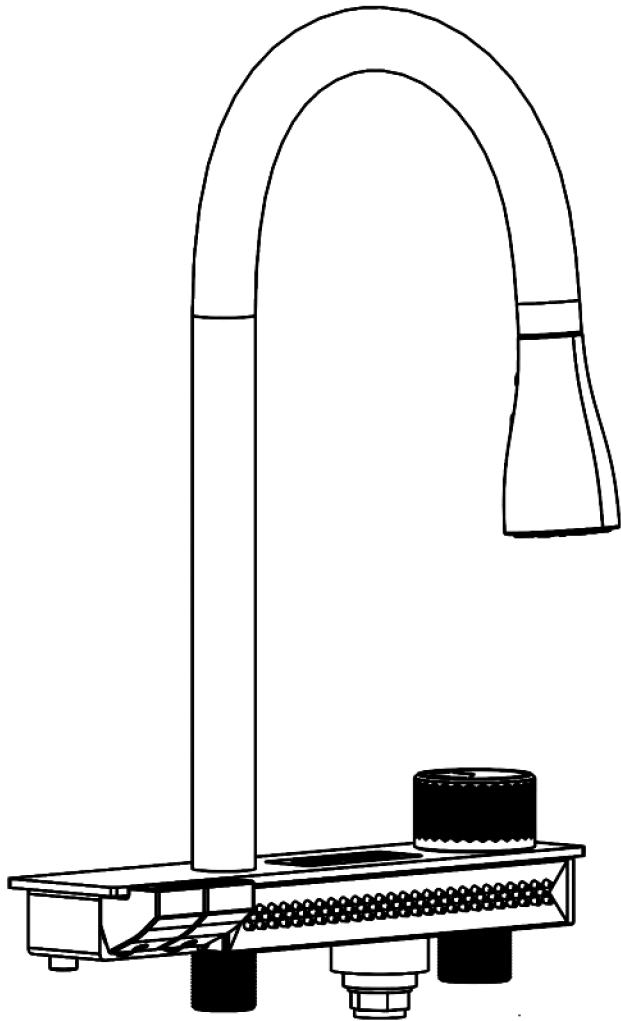

\*\*Please indicate the color number when ordering

## Pull the kitchen basin faucet

### Before Installation:

All the materials are compiled according to the newly published product materials. The company reserves the right to change the characteristics, packaging or types of products available at any time without notice.

The instruction manual includes important installation, maintenance and cleaning contents, please give these materials to the user to read.

### Note:

1. Be sure to thoroughly flush the water supply pipe to remove impurities from the pipe.
2. If you are installing a new sink, install the faucet on the basin first.
3. Work pressure of Huajiu: 0.1MPa to 0.5MPa. A pressure reducing valve must be installed when the water pressure exceeds 0.5Mpa. The highest work of shower temperature and ambient temperature: 60 °C. Please pay special attention to the arm tube connected with the flower wine should be kept away from the heater, otherwise it is possible damage the flower wine and its seals, and even cause harm to the user.

### Instructions for Use:

The handwheel switch rotates to the left to set the temperature of cold water, mixed water and hot water, and to the right to turn off the main outlet switch.

Press the button on the left to control the way of water outlet.

\* The handwheel is the main switch, explosion-proof pressure (2.5MPa), each time after use must be closed, if there is no closing caused by the loss, the wood company will not be responsible.

### Mounting size:

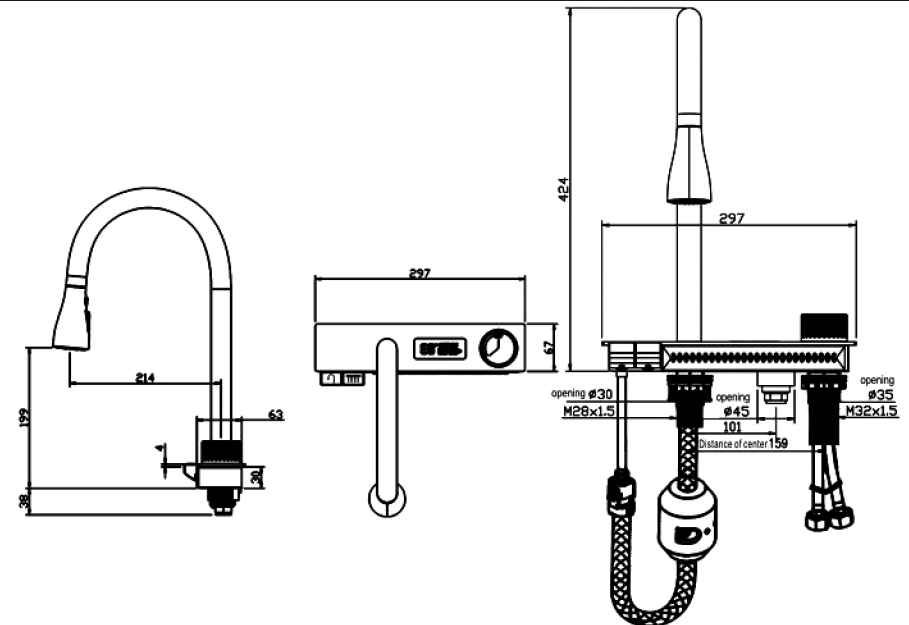

## Installation Procedure

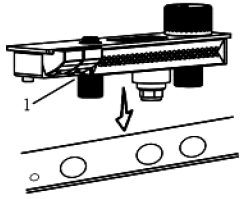

1. Install the gasket (1), face down with the gasket, install the faucet, and place the handwheel on the right.

2. Insert the faucet body into the sink hole in the direction indicated by the arrow.

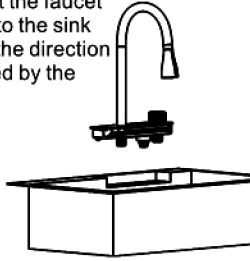

3. The drawing pipe is connected with the shower through the bend to check whether the pull is smooth.

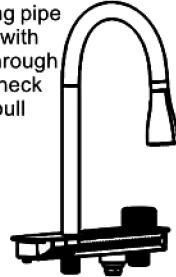

## Use the Guide



Hand wheel switch, rotate to the left fixed temperature cold water - mixed water - hot water; Turn to the right to turn off the water main switch (Always turn it off after each use)

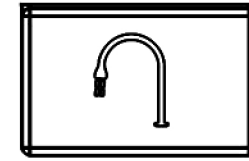

Shower head water button (Cannot be used as main switch)

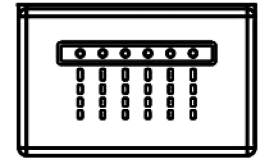

Shark water button (Cannot be used as main switch)

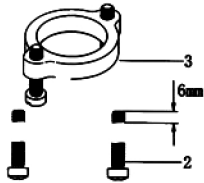

4. Screw (2) into the mounting ring (3) until the screw is exposed 6mm.

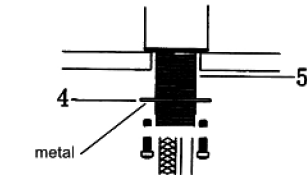

5. Install the gasket (4) on the dental canal (5) and screw the mounting ring on the dental canal.

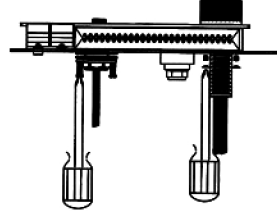

6. Adjust the position and tighten the screws on the mounting ring.



The digital screen displays the outlet temperature and outlet time.

Free drawing of pull head

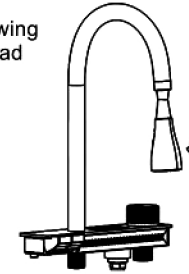

Press to switch shower water

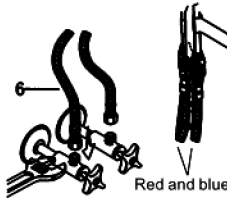
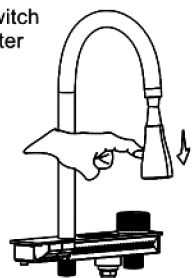

7. Connect and lock the hot and cold pipe (6) to the water source. The cold water is connected to the blue tube and the hot water to the red tube.

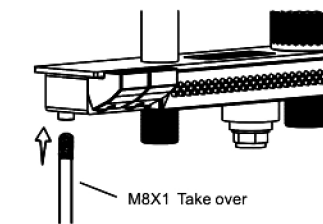

8. Install the M8 × 1 quick takeover on the main body turn it on and lock it.

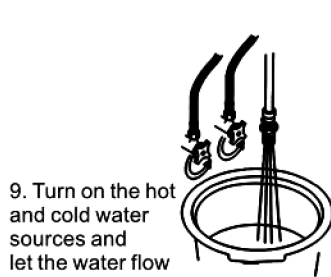

9. Turn on the hot and cold water sources and let the water flow about two minutes.

Press to change the bubble water

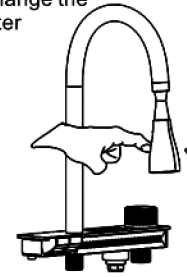

Faucet maintenance:  
1. Turn on the faucet and rub the nozzle to clean impurities.

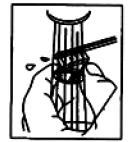
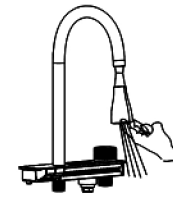

2. When impurities make the water flow smaller, remove the sprinkler head bubbler, clean the bubbler, and reinstall it

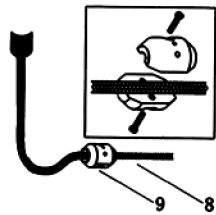

10. Install the gravity ball (9) on the shower hose (8) without locking the gravity ball first.

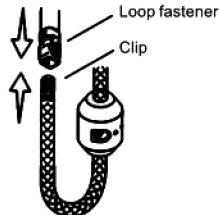

11. Connect shower hose to quick hose.

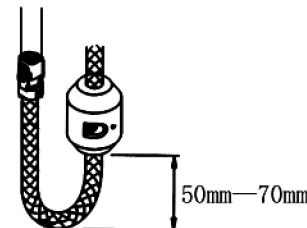

12. Adjust the gravity ball to the proper position and lock it as shown in the picture.

## Installation Completion Check

Check and make sure all joints are tight and hand wheel is in closed position. Turn on the main water and drainage system, check and repair leaking interfaces.

## Cleaning Instructions

Apply to all processed surfaces: Clean the coated surface with neutral soapy water and dry the entire surface thoroughly with a clean soft cloth. Many cleaners, such as ammonia, detergent powder and toilet cleaner, will cause damage to the coating surface and should not be used. Wear cleaning appliances or cleaners should not be used on faucets and accessories.