

5

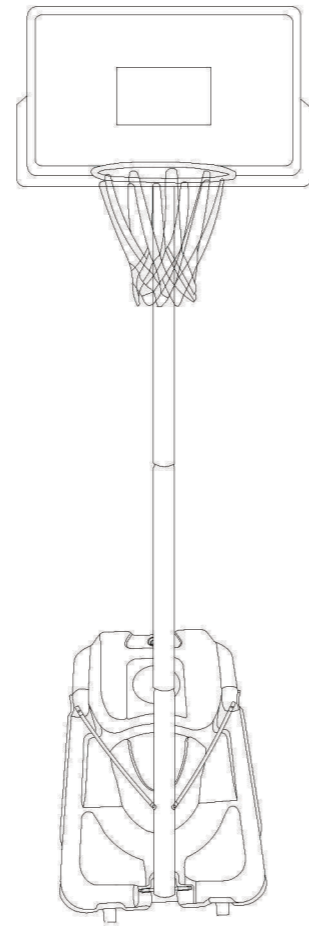

# BASKETBALL STAND ASSEMBLY INSTRUCTION

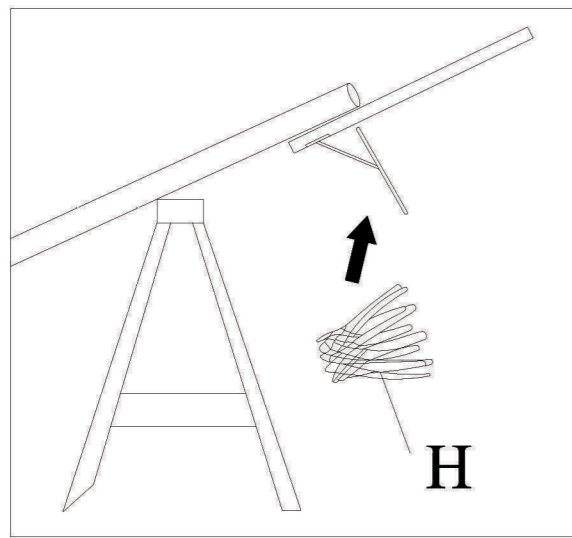
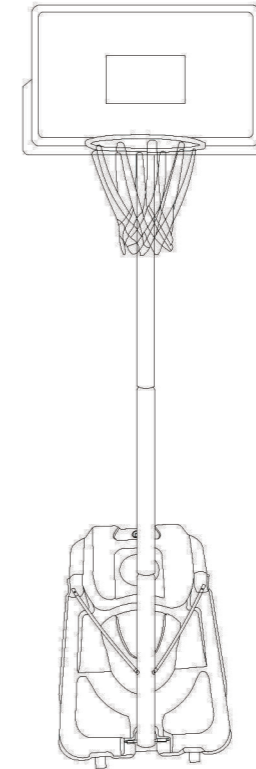

THANK YOU FOR PURCHASING BASKETBALL STAND

## PARTS LIST

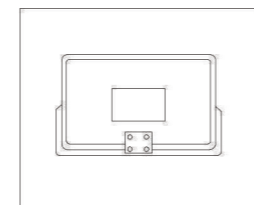

A 1 x Basketball board

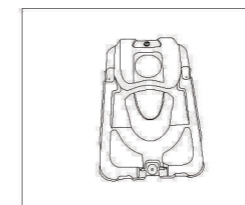

B 1 x Tank (black)

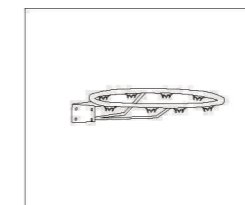

C 1 x Rim

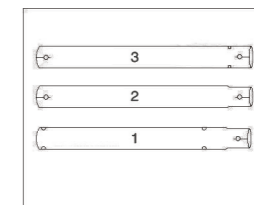

D 3 x Pillar tube

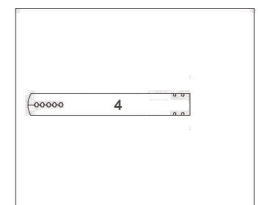

E 1 x Pillar tube

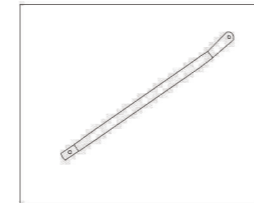

F 2 x Tank strut

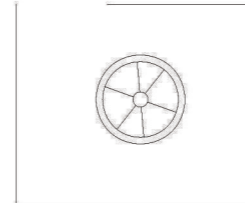

G 2 x Wheels

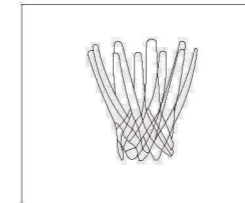

H Net

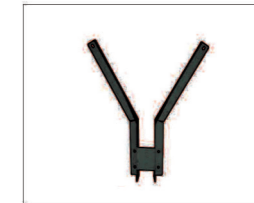

I 1 x Backboard racks



J 1 x Wheel Axle

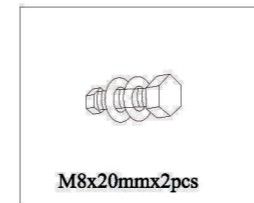

M8x20mmx2pcs

K Screw

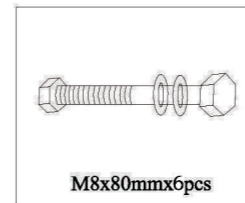

M8x80mmx6pcs

P 1 x Screw

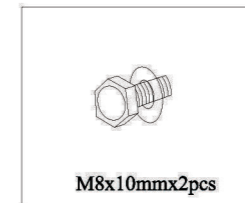

M8x10mmx2pcs

M 2 x Screw

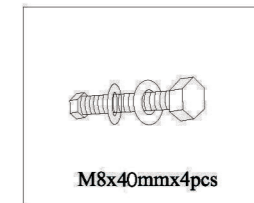

M8x40mmx4pcs

N Screw

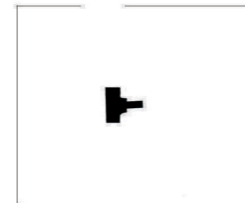

Z X3pcs

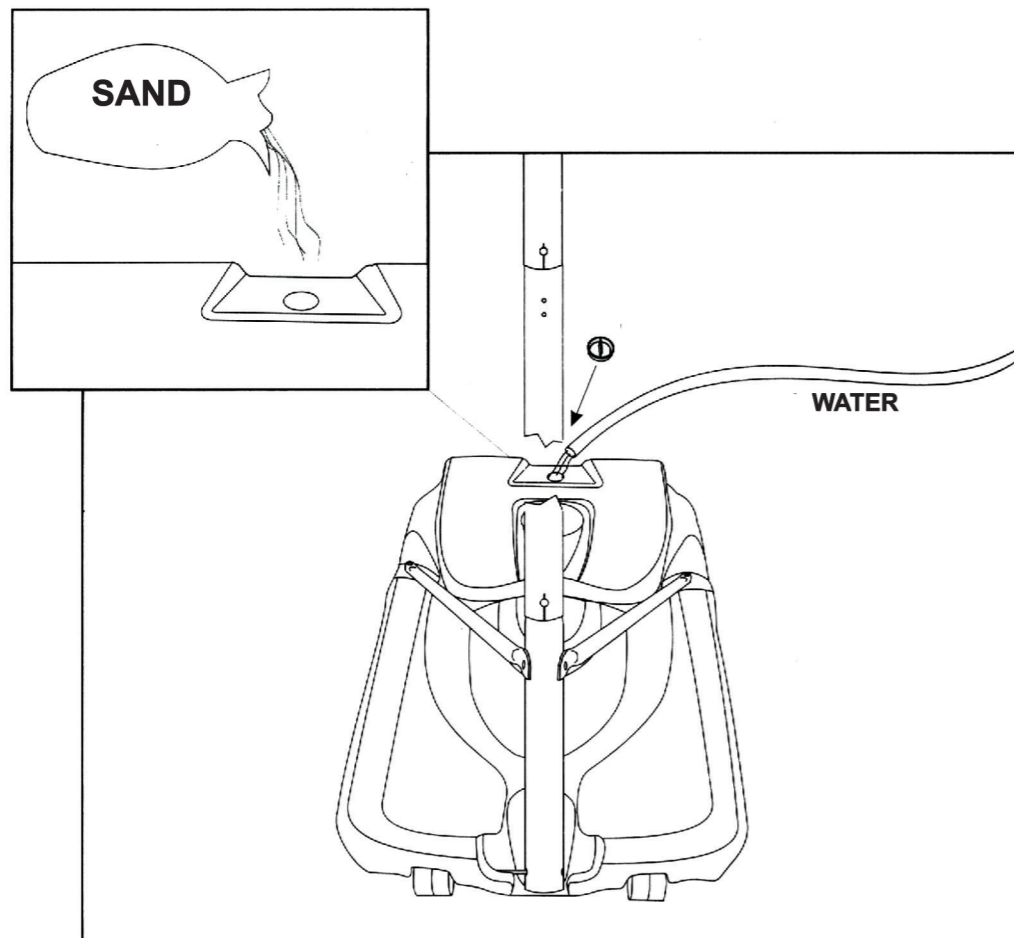

1

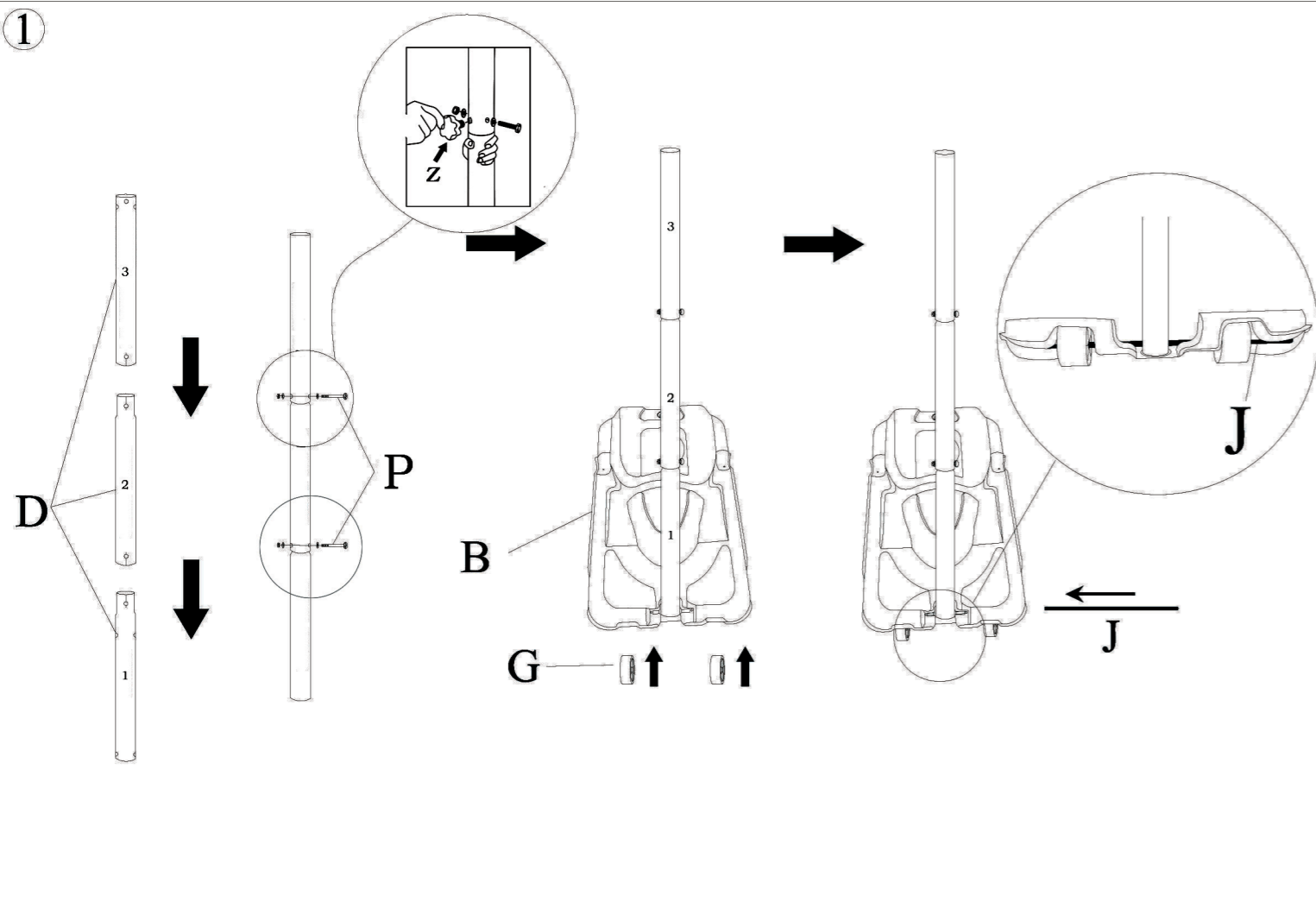

2

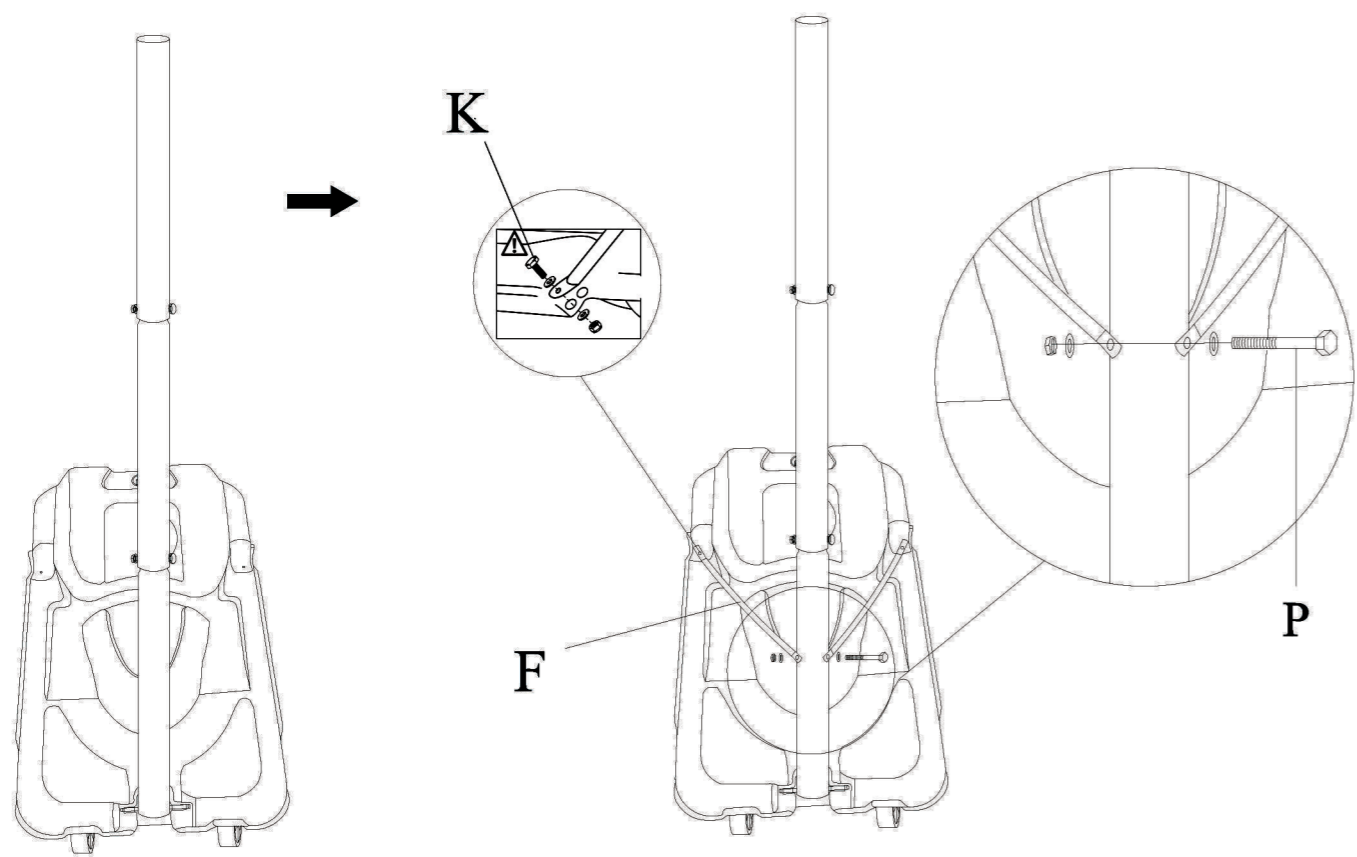

3

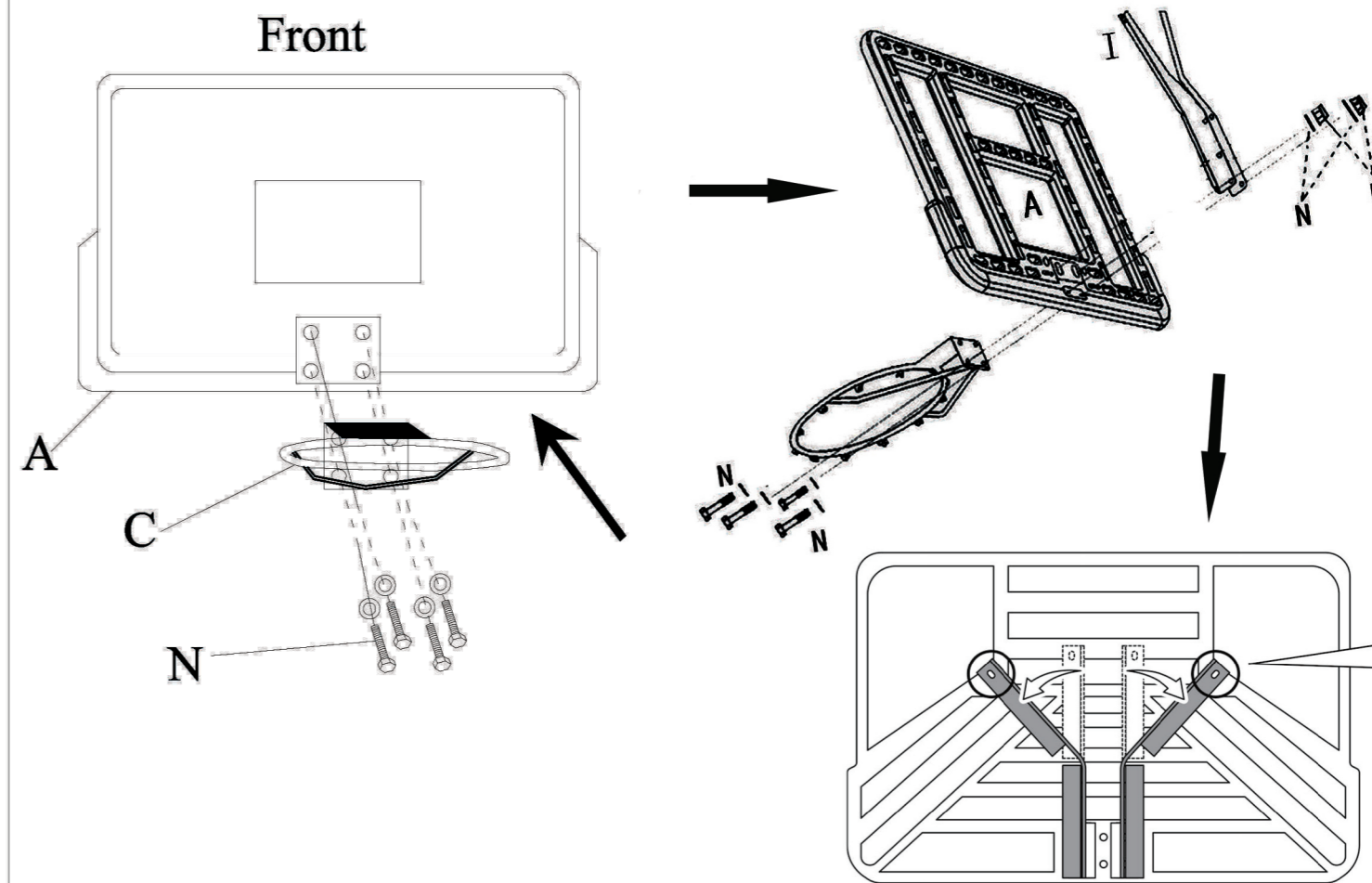

4

