

CARE AND MAINTENANCE

Leather surfaces on should be dusted regularly with a dry or slightly damp soft cloth
Avoid using saddle soap or other cleaners. Leather desks and tabletops have a lacquer coating, therefore they can be lightly waxed. Suede surfaces should only be cleaned with a dry, stiff brush. Exposure to liquid spills should be avoided since suede cannot be washed or cleaned like leather. 100% Safavieh Bicast Leather.









NOTICE

* Please make sure that you have all parts indicated before you begin assembly of this item

* This item should be assembled on a soft surface to prevent scratching the finish during assembly

* This item may require periodic tightening

Part List and Hardware List

PIECE	DESCRIPTION	PICTURE	QUANTITY
A	SEAT		1X
B	Iron Footrest		1X
C	Iron cross pallet		1X
D	Iron Legs(same size)		4X
HW1	Flat Hex bolt 4x1x25MM		4X
HW2	Hex bolt 4x1x20MM		8X
HW3	Hex bolt 4x1x25MM		8X
HW4	Allen key M6		1X
HW5	Allen key M5		1X

Product Dimensions:W19.6"XD22.4"XH36.6"

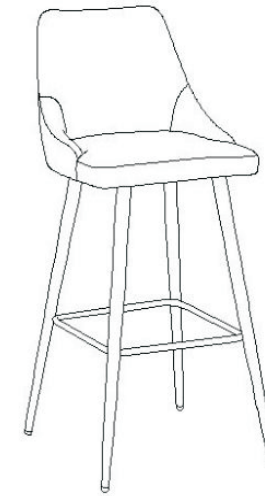

WARNING:
WEIGHT CAPACITY 260 LBS.
NO NOT STAND ON CHAIR

PREPARATION

Before beginning assembly of product, make sure all parts are present. Compare parts with package contents list and hardware contents list.

If any part is missing or damaged, do not attempt to assemble the product.

Estimated Assembly Time: 15 minutes.

Tools Required for Assembly (included): Allen Key

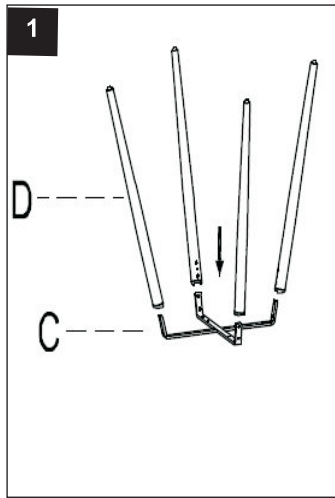

Step 1
Pls insert four Iron legs(D) into cross pallet(C) as the picture, pls pay more attention to aim the holes.

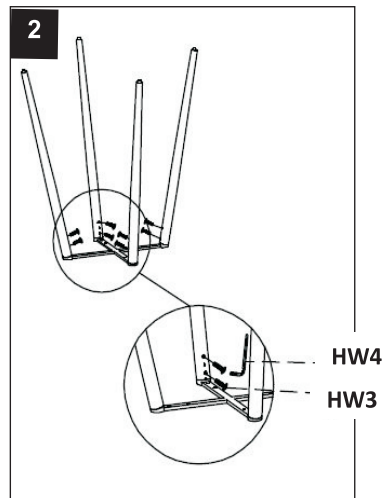

Step 2
Using the Allen key M6(HW4) to fix with Hex bolts (HW3) for assemble the legs and cross pallet.

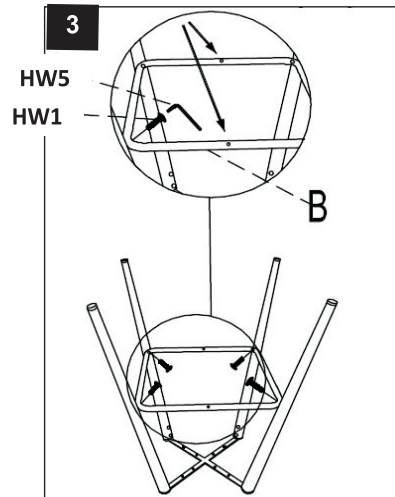

Step 3
Then put the footrest(B) in the middle of Iron legs as picture showed
And used the Allen keyM5(HW5) to fix with Flat Hex bolts(HW1).

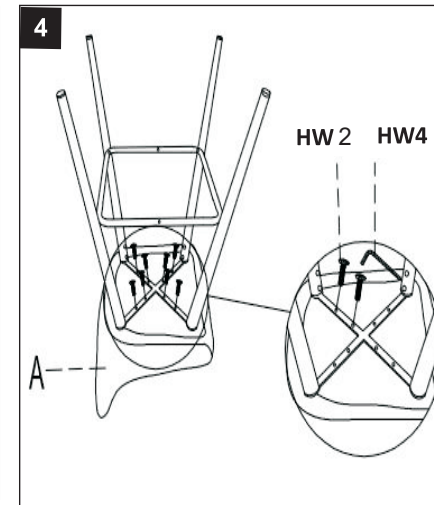

Step 4
Put the whole frame in the bottom of seat(A)
Used Allen key M6(HW4) with Hex bolts (HW2) at last.

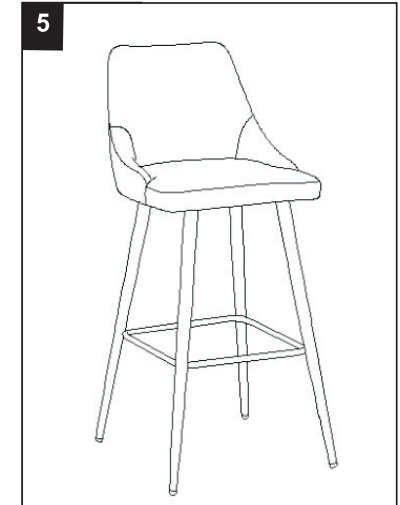

Step 5
Assembled finishing as picture showed.