

ASSEMBLY INSTRUCTIONS

Adjustable Height Table

ASSEMBLY

30 MINUTES

1-Person

Tools Required: 

REQUIREMENTS

Assembly Time
(Approximate)

Assembly

(Not Provided) Phillips Screwdriver

Thank you for purchasing our product!

Please refer and use this assembly instruction to assemble the product.

Contact our customer service department in case there are any missing or damage parts or hardware. Replacement parts are normally shipped within 2 or 3 days.

We appreciate your business!

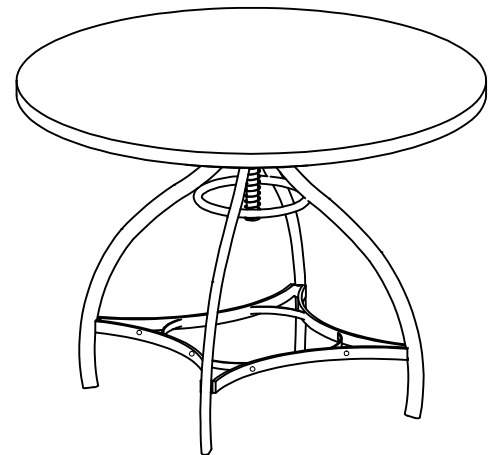

ASSEMBLY PREPARATION

1. Remove all packaging materials, staples and packing straps from the carton.
2. Refer to Parts List and Hardware List and ensure they are complete before you start assembling.
3. Place all wooden parts on a clean, flat and soft surface (e.g. carpet or rug) to prevent parts from getting scratched.

SAFETY PRECAUTION:

1. KEEP ALL HARDWARE PARTS OUT OF REACH OF CHILDREN.
2. DISPOSE PLASTIC PACKAGING MATERIAL IMMEDIATELY TO AVOID ANY RISK OF SUFFOCATION TO CHILDREN AND ANIMALS.

TIPS FOR ASSEMBLY:

1. Allow ample room for assembly and in close proximity to where product will be placed.
2. Assemble the product on a surface that does not scratch or damage the exterior gloss and finish of the furniture.
3. Please check all of the parts and quantities are included before assembly.
4. Identify all of the parts, hardware and quantities required for each step.
5. During assembly, do not over-tighten any fittings as this may cause damage.
6. DO NOT USE POWER TOOLS TO ASSEMBLE THIS PRODUCT.
7. Always place the product on a flat surface.
8. Do not sit or stand on the partially assembled product; only use the product for which it is intended.

CARE AND MAINTENANCE









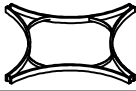

- Use a slightly damp cloth to clean the product. Do not use bleach or abrasive cleaning material.
- Check all the fittings periodically and re-tighten as necessary. Do not use the product if any of the parts is damaged or broken.
- Never allow any kind of liquid to remain on your furniture. Absorption can cause wood to warp or delaminate.
- Do not place hot items (e.g. hot drinks) directly onto the wood surface.
- Do not drag and/or pull the furniture.

This product is for indoor and household use only - not for commercial use.

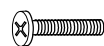
ASSEMBLY INSTRUCTIONS

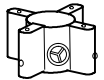
Adjustable Height Table

PARTS & HARDWARE LISTS

A		LEG	4PCS	H		BOLT	13PCS
B		LOWER STRETCHER	1PC	I		BOLT	12PCS
C		POST	1PC	J		BOLT	3PCS
D		UPPER STRETCHER	1PC	K		FLAT WASHER	4PCS
E		CONNECTING BAR	1PC	L		SPRING WASHER	4PCS
F		WOOD TABLE TOP	1PC	M		ALLEN WRENCH	1PC
G		PLASTIC RING	1PC				

STEP 1

DO NOT USE POWER TOOLS.

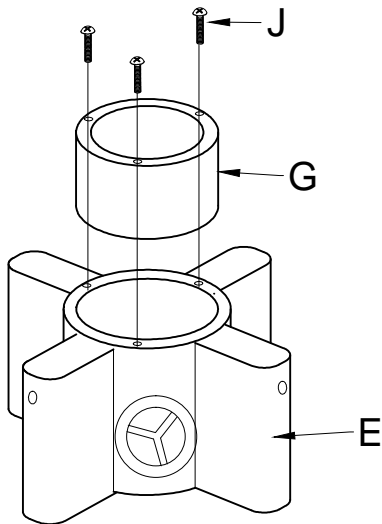

Place Plastic Ring (G) into the Connecting Bar (E) and fasten with Bolt (J). Use a Phillips Screwdriver to tighten all the bolts.

STEP 2

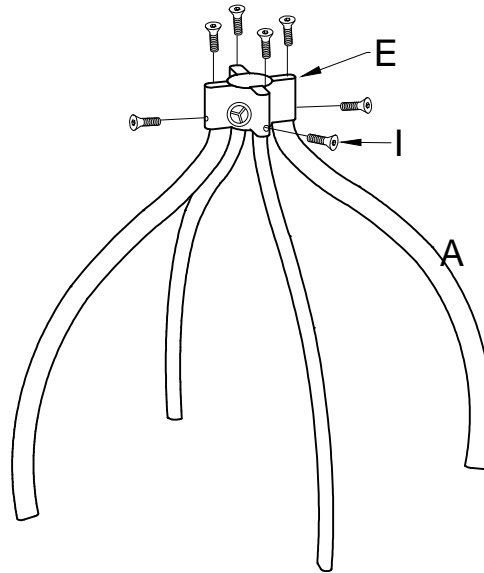

Insert Leg (A) into Connecting Bar (E) as shown and use Bolt (I) to fasten. Use Allen Wrench (M) to drive (I). **Do not tighten the bolts completely at this time.**

STEP 3

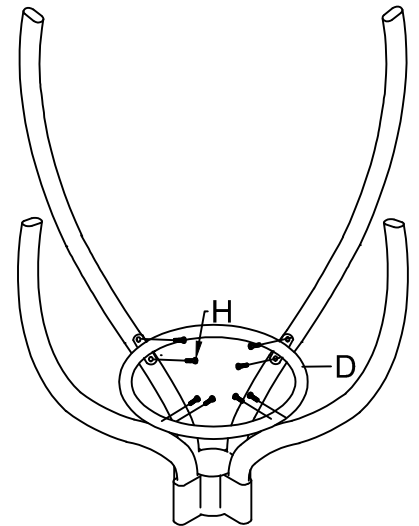

Place assembly from STEP 2 as shown. Position Upper Stretcher (D) as shown to align bolt holes on (D) and Leg (A). Use Bolt (H) to fasten (A) to (D). Use Allen Wrench (M) to drive (H). **Do not tighten (H) completely at this time.**

ASSEMBLY INSTRUCTIONS

Adjustable Height Table

STEP 4

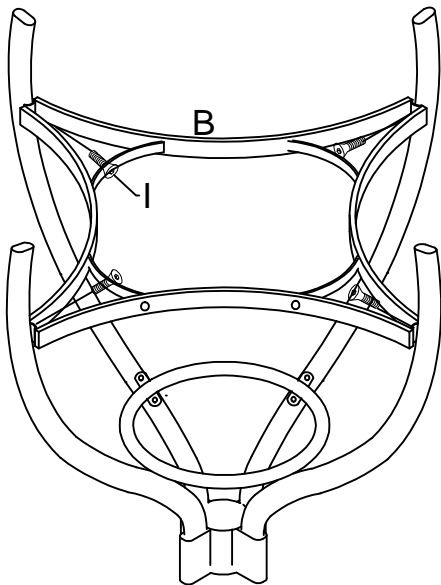

- Fasten individual Leg (A) to Lower Stretcher (B) by using Bolt (I). Use Allen Wrench (M) to drive (I). Do not tighten (I) completely until all the bolts are in place on (B).
- Tighten all the bolts in STEP 1 & 2 completely at this time.

STEP 5

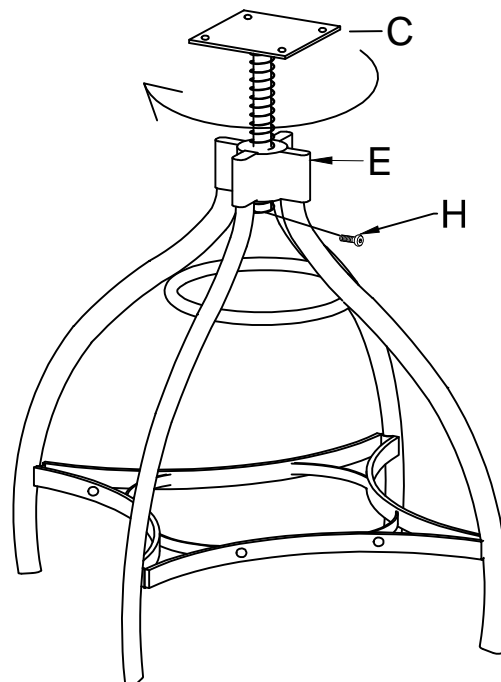

Insert Post (C) into Connecting Bar (E) and turn clockwise, and ensure helix thread of (C) extend below (E). Affix Bolt (H) at the end of (C) to serve as a stopper as shown.

STEP 6

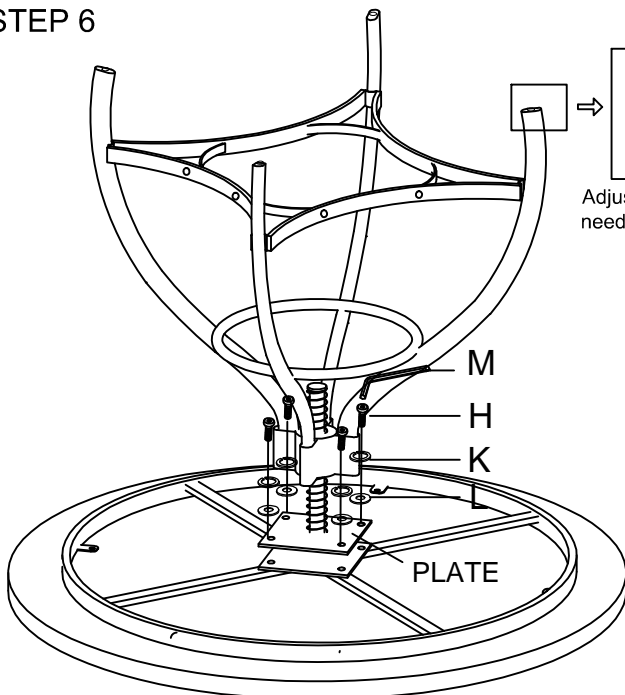

Place Table Top (F) bottom-side up and align bolt holes on plate of Post (C) to bolt holes on (F) as shown. Use Bolt (H) fitted with Washers (K & L) to fasten (F) to (C). Do not tighten completely until all the bolts are in place.

STEP 7

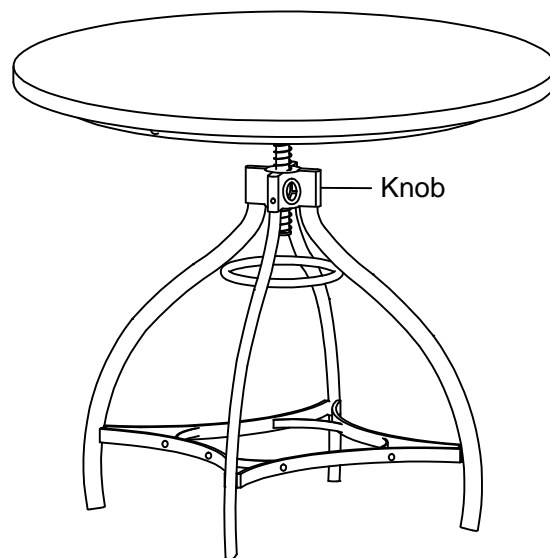

Place table right-side up. The assembly of the table is complete. Turn Table Top (F) clockwise to lower and counter-clockwise to raise the height of table. Use knob on Connecting Bar (E) to lock the desired table height.